



Surface Mount General Purpose Silicon Rectifiers

Reverse Voltage - 50 to 1000 V

Forward Current - 5 A

FEATURES

- For surface mounted applications
- Low profile package
- Glass Passivated Chip Junction
- Easy to pick and place
- Lead free in comply with EU RoHS 2011/65/EU directives

MECHANICAL DATA

- Case: SMB
- Terminals: Solderable per MIL-STD-750, Method 2026
- Approx. Weight: 0.095g / 0.003oz

PINNING

PIN	DESCRIPTION
1	Cathode
2	Anode

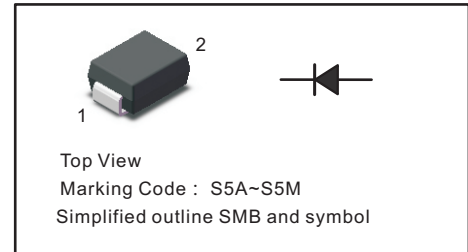

Maximum Ratings and Electrical characteristics

Ratings at 25 °C ambient temperature unless otherwise specified.

Single phase half-wave 60 Hz, resistive or inductive load, for capacitive load current derate by 20 %.

Parameter	Symbols	S5AB	S5BB	S5DB	S5GB	S5JB	S5KB	S5MB	Units
Maximum Repetitive Peak Reverse Voltage	V_{RRM}	50	100	200	400	600	800	1000	V
Maximum RMS voltage	V_{RMS}	35	70	140	280	420	560	700	V
Maximum DC Blocking Voltage	V_{DC}	50	100	200	400	600	800	1000	V
Maximum Average Forward Rectified Current	$I_{F(AV)}$	5							A
Peak Forward Surge Current 8.3 ms Single Half Sine Wave Superimposed on Rated Load	I_{FSM}	200							A
Maximum Instantaneous Forward Voltage at 5 A	V_F	1.1							V
Maximum DC Reverse Current at Rated DC Blocking Voltage $T_a = 25\text{ }^\circ\text{C}$ $T_a = 125\text{ }^\circ\text{C}$	I_R	10 100							μA
Typical Junction Capacitance ⁽¹⁾	C_j	40							pF
Typical Thermal Resistance ⁽²⁾	$R_{\theta JA}$ $R_{\theta JC}$	48 16							$^\circ\text{C/W}$
Operating and Storage Temperature Range	T_j, T_{stg}	-55 ~ +150							$^\circ\text{C}$

(1) Measured at 1 MHz and applied reverse voltage of 4 V D.C

(2) P.C.B. mounted with 2.0" X 2.0" (5 X 5 cm) copper pad areas.



Fig.1 Forward Current Derating Curve

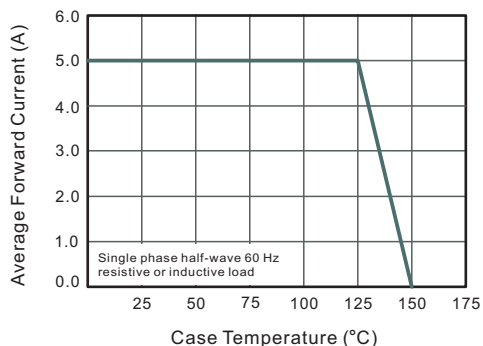

Fig.2 Typical Instantaneous Reverse Characteristics

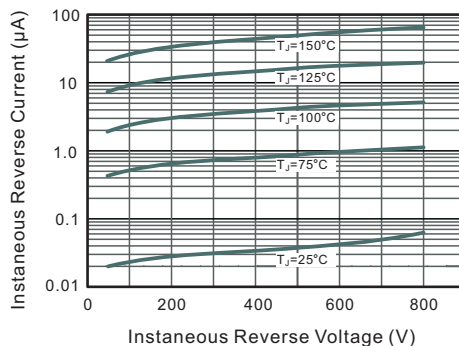

Fig.3 Typical Forward Characteristic

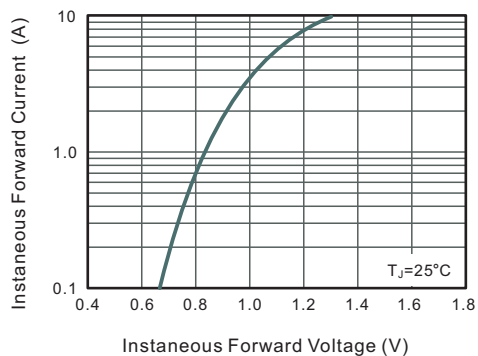

Fig.4 Typical Junction Capacitance

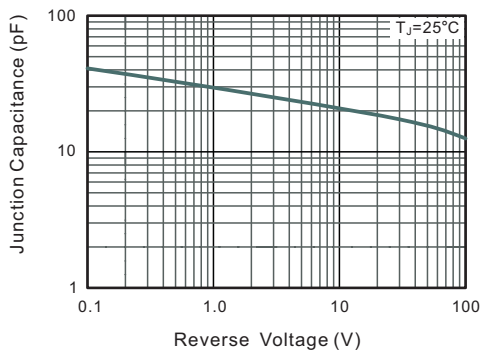
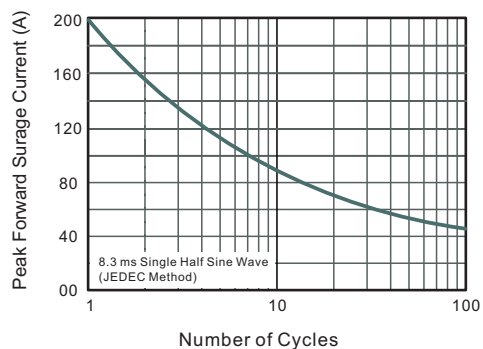

Fig.5 Maximum Non-Repetitive Peak Forward Surge Current





PACKAGE OUTLINE

Plastic surface mounted package; 2 leads

SMB

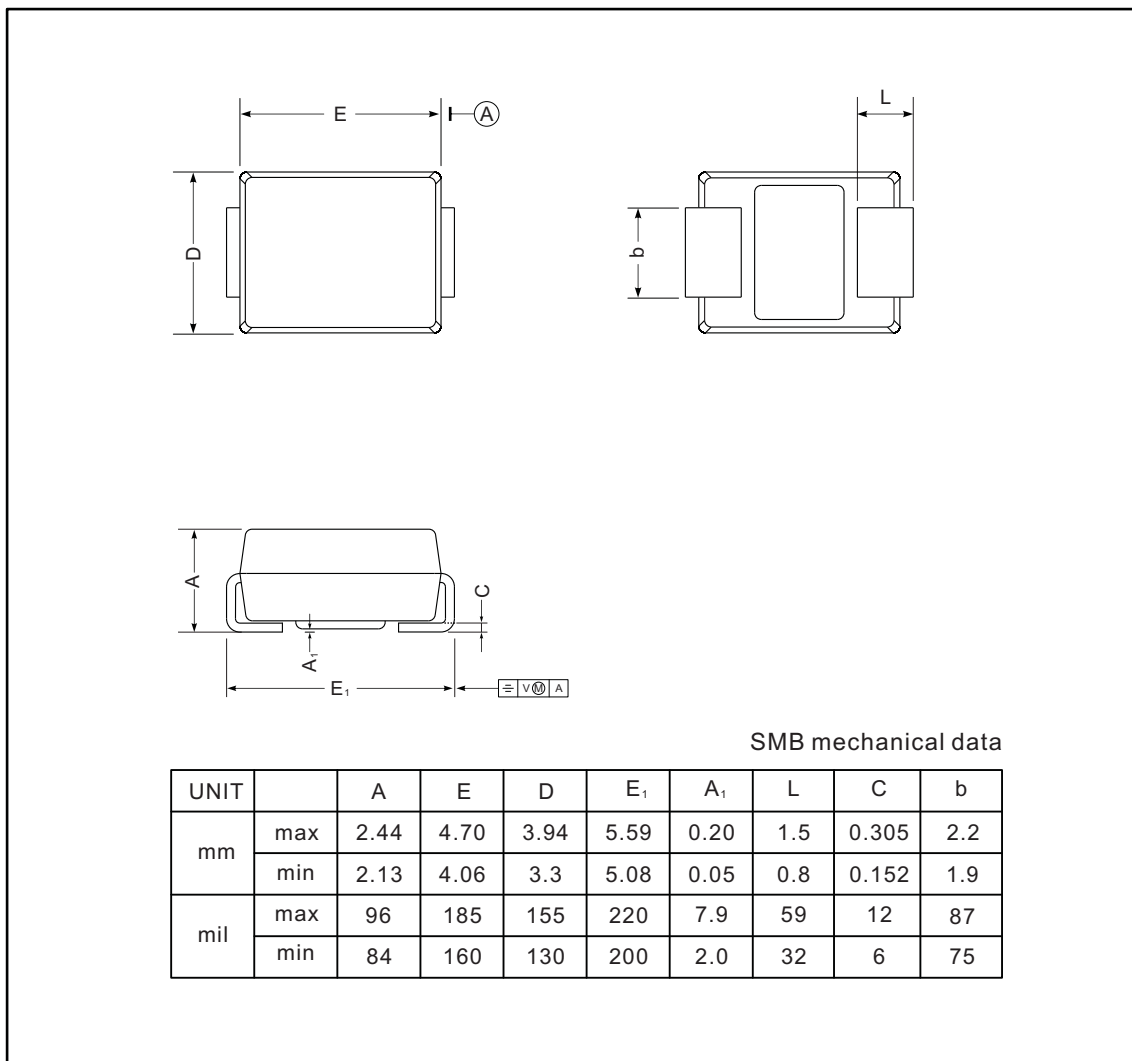

The recommended mounting pad size

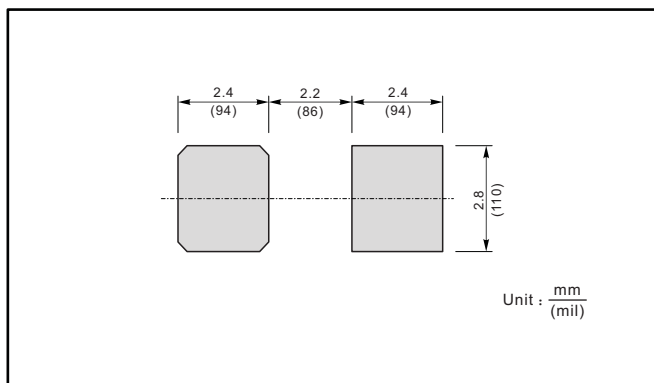

Marking

Type number	Marking code
S5AB	S5A
S5BB	S5B
S5DB	S5D
S5GB	S5G
S5JB	S5J
S5KB	S5K
S5MB	S5M