

# EXTERNSION

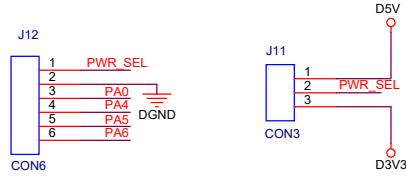

# DOWNLOAD

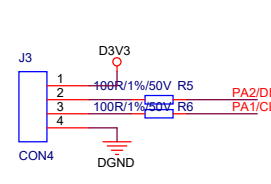

# POWER

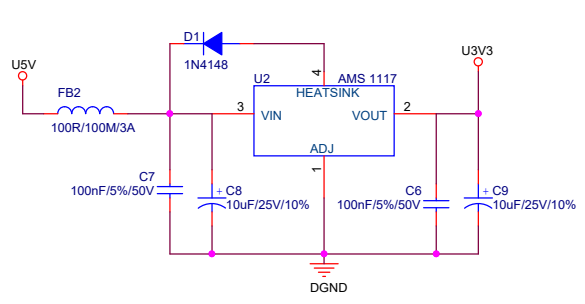

# SWITCH

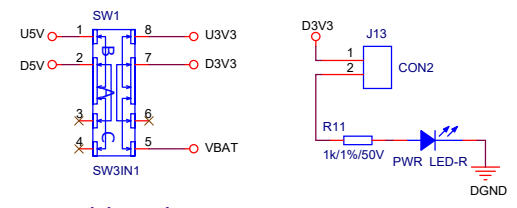

up: powered by usb  
 mid: shutdown, D3V3 can be powered by external energy to test lowpower  
 down: powered by battery

# MCU

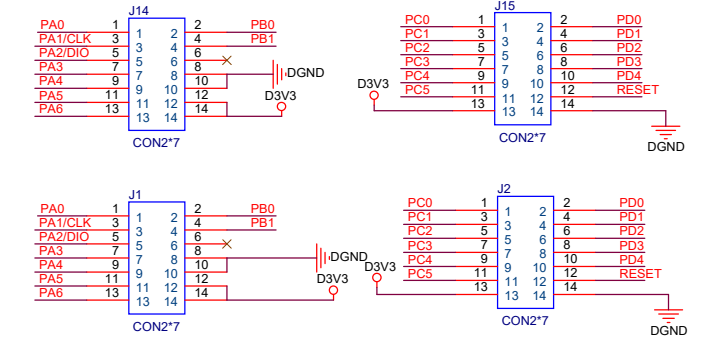

# UART to USB

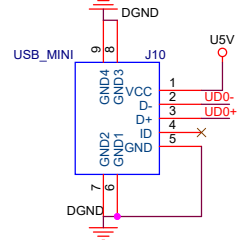
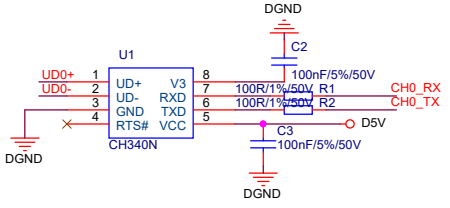
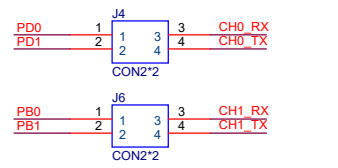

# OLED

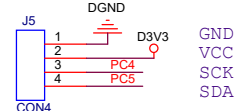

# LED

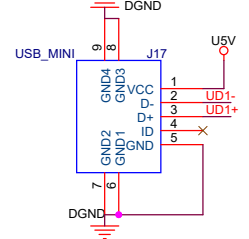
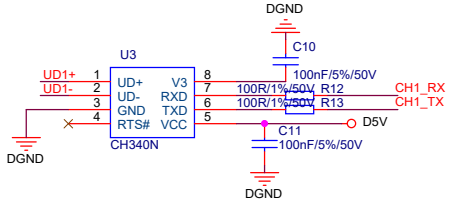
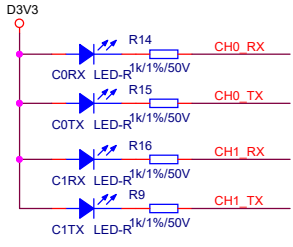
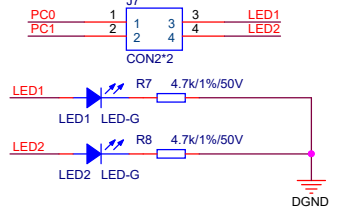

# FIXED HOLE

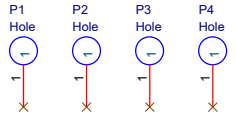

# BATTERY

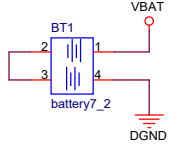

# KEY

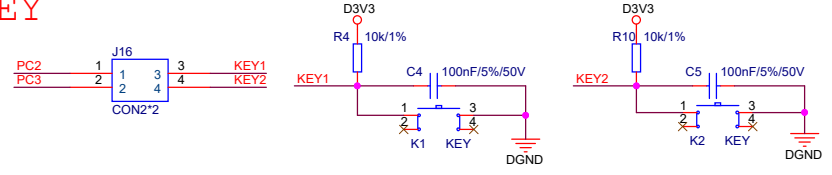

# RESET

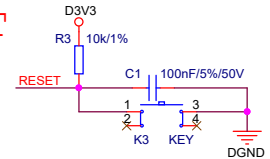

Title			<Title>
Size	Document Number	Rev	
Custom	<Doc>	<Rev C>	
Date:	Thursday, April 14, 2022	Sheet	1 of 2