

100PIN: BB42-AOAT-1B-XHR

REV.	ECN Number	Description	Drawn
1	CS18030011	First issue	LGJ_2018.03.05
2	E20010009	Add new specifications	Smark
3	E20100007	图面整合(每个料号单独列出)	FQH_2020.10.13

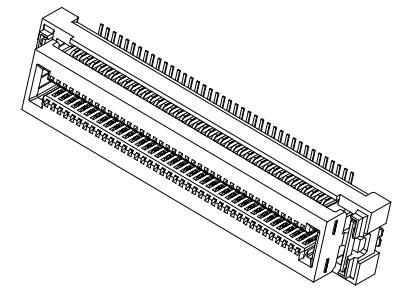

- NOTES:
- HOUSING MATERIAL:HIGH TEMPERATURE PLASTICS  
BLACK, UL94V-0.
  - CONTACT MATERIAL:COPPER ALLOY.
  - RATING VOLTAGE: 50V AC/DC
  - CONTACT RESISTANCE: 80 m ohms MAX, INITIAL.
  - DIELECTRIC WITHSTANDING VOLTAGE: 500V AC rms./MINUTE.
  - INSULATION RESISTANCE: 100 M ohms MIN.
  - CURRENT RATING: 0.5 AMPERE.
  - DURABILITY: 30 CYCLES MIN.
  - INSERTION FORCE: 150g MAX. PER CONTACT.
  - WITHDRAW FORCE: 8.5g MIN. PER CONTACT.
  - OPERATING TEMPERATURE RANGE: -40° C~+105° C
  - STORAGE TEMPERATURE RANGE: -40° C~+105° C
  - ALL HARMFUL SUNSTANCES SHOULD BE COMPLIANT WITH THE ROHS2.0 REQUIREMENTS.
  - PRODUCT NUMBER MATRIX:

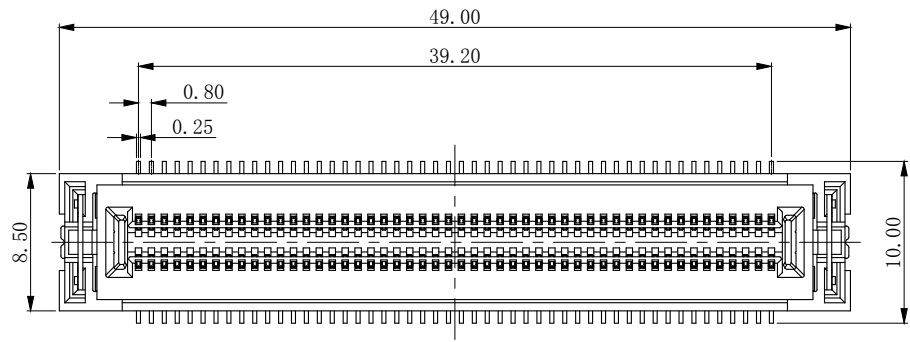
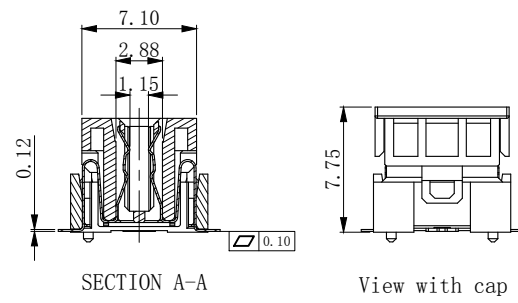
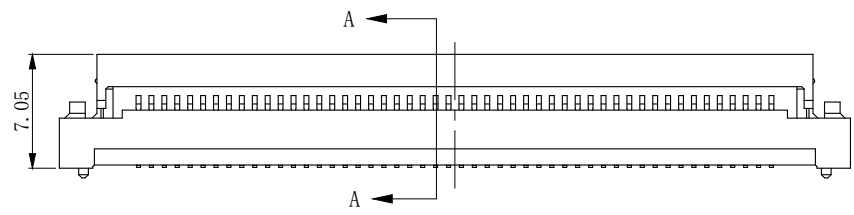

Pitch: 0.80mm  
 Female  
 PIN NO.  
 Height flow code  
 SMT TYPE

BB42-XXAT-1B-XHR

packaging: REEL+PAD  
 Halogen-free high temperature material  
 Electroplating code

◎ Gold plated				
flash	B	1u"	R	3u"
5u"	D	10u"	E	15u"
20u"	G	25u"	H	30u"

Colour : black  
 Extended code

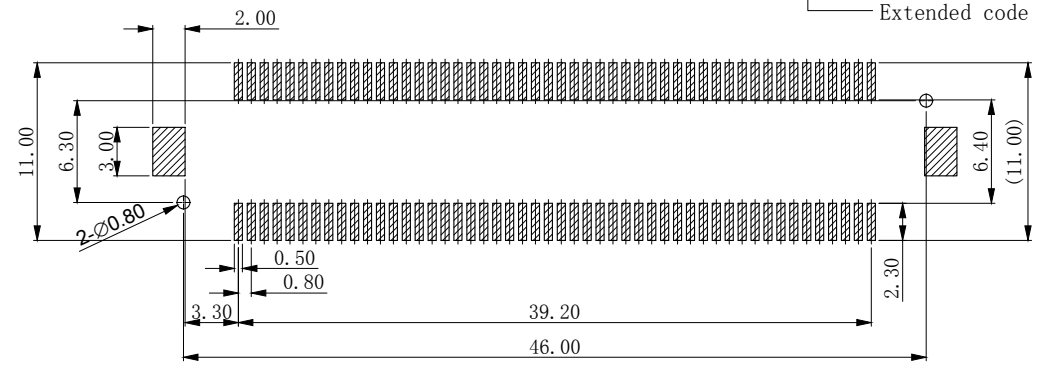
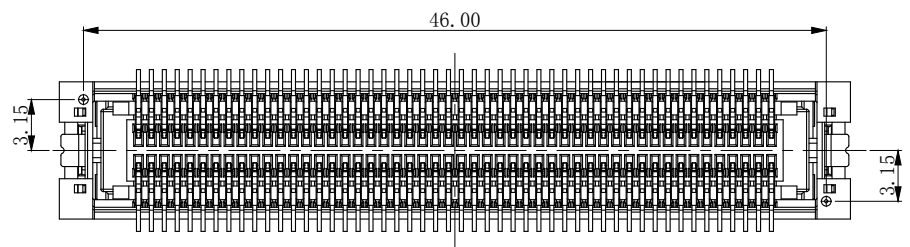

RECOMMENDED PCB LAYOUT  
 TOLERANCE: ±0.05mm



TOLERANCE UNLESS OTHERWISE SPECIFIED				SCALE 1:1	ORIGINAL DRAWN: Qinghua Fu	DATE 2020.10.13	DWG. NO. 600-0000-0228	TITLE	REV. 3
X.X	±0.30	X.°	±3°	UNIT mm	CHECK: Guangyu Guo	DATE 2020.10.13	PARTS NO. (INTENDED USE) BB42-XXAT-1B-XHR	CUSTOMER DRAWING	SHEET
X.XX	±0.20	X.X°	±2°	SIZE A4	APPROVE: Ady Zhou	DATE 2020.10.13			1/2
X.XXX		X.XX°	±1°						

40PIN: BB42-40AT-1B-XHR

60PIN: BB42-60AT-1B-XHR

80PIN: BB42-80AT-1B-XHR

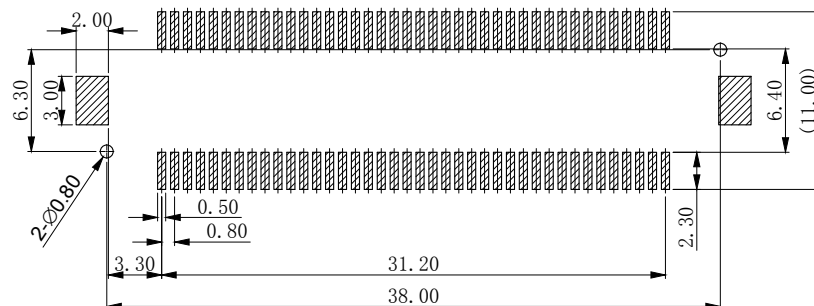
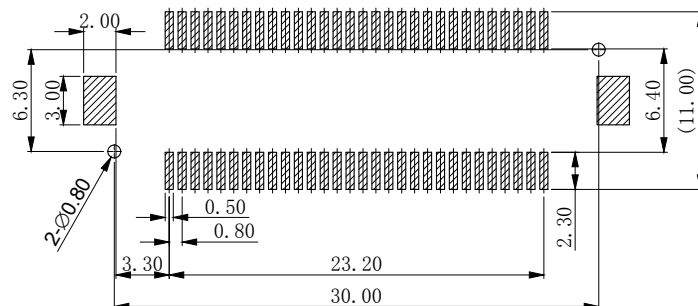
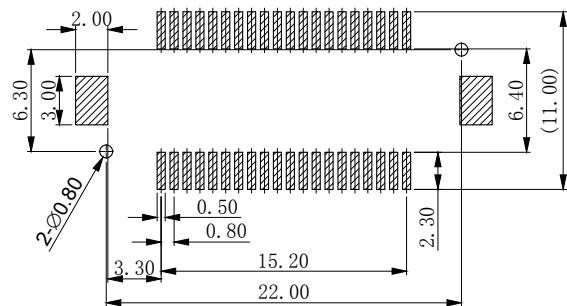
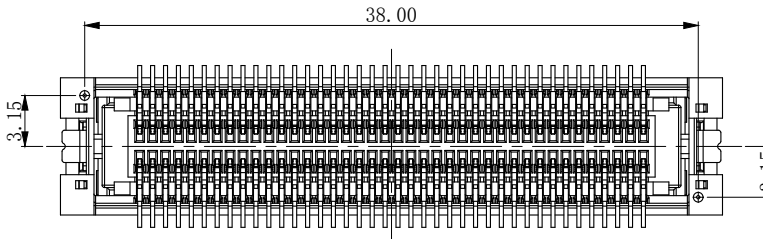
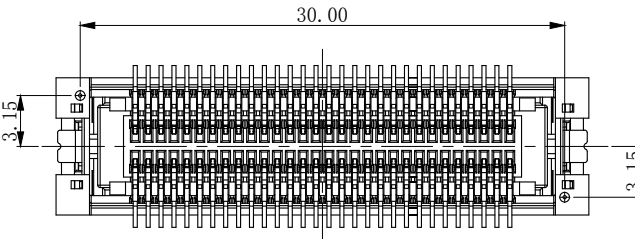
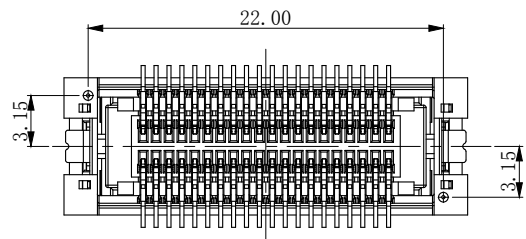
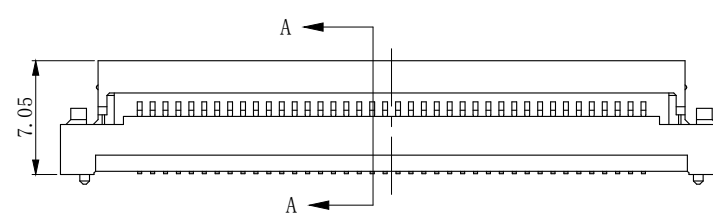
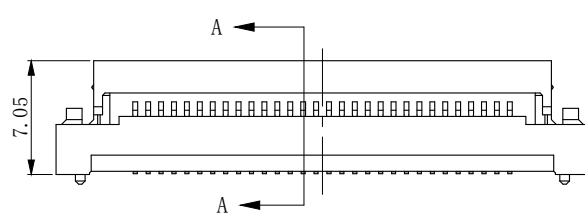
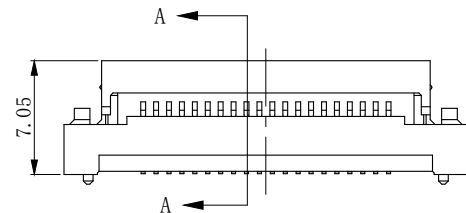
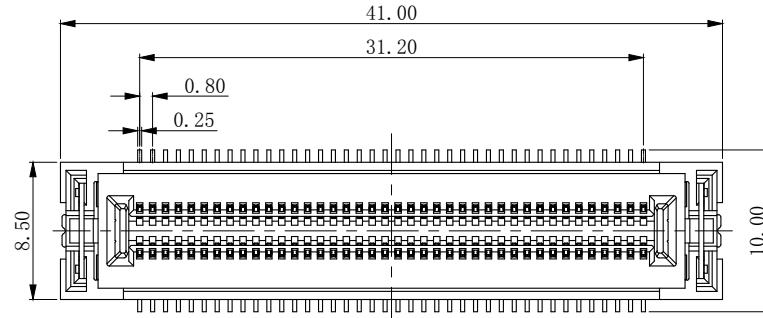
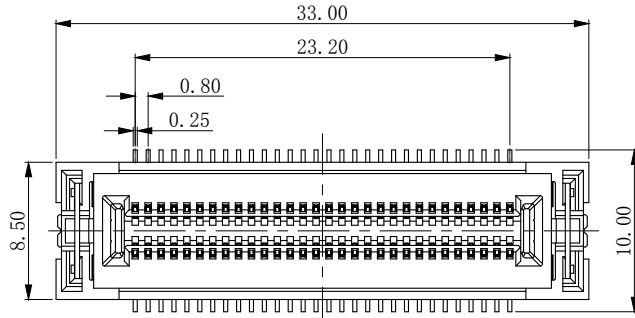
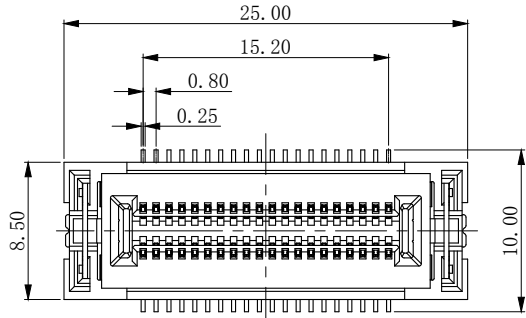

RECOMMENDED PCB LAYOUT

TOLERANCE:  $\pm 0.05\text{mm}$

RECOMMENDED PCB LAYOUT

TOLERANCE:  $\pm 0.05\text{mm}$

RECOMMENDED PCB LAYOUT

TOLERANCE:  $\pm 0.05\text{mm}$



Shenzhen ShenTai weixiang Electronics Co., Ltd.

TOLERANCE UNLESS OTHERWISE SPECIFIED

X.X	$\pm 0.30$	X.°	$\pm 3^\circ$
X.XX	$\pm 0.20$	X.X°	$\pm 2^\circ$
X.XXX		X.XX°	$\pm 1^\circ$

SCALE	1:1
UNIT	mm
SIZE	A4



ORIGINAL DRAWN:	Qinghua Fu
CHECK:	Guangyu Guo
APPROVE:	Ady Zhou

DATE	2020.10.13
DATE	2020.10.13
DATE	2020.10.13

DWG. NO.	600-0000-0228
PARTS NO. (INTENDED USE)	BB42-XXAT-1B-XHR

TITLE	CUSTOMER DRAWING
REV.	3
SHEET	2/2