



# TF2110M/2113M

## High-Side and Low-Side Gate Drivers

### Features

- Drives two N-channel MOSFETs or IGBTs in high-side / low side configuration
- The floating high-side operates to 600V
- 2.5A sink / 2.5A source typical output currents
- Outputs tolerant to negative transients
- Wide gate driver supply voltage range: 10V to 20V
- Wide logic input supply voltage range: 3.3V to 20V
- Wide logic supply offset voltage range: -5V to 5V
- 15 ns (typ) rise / 13 ns (typ) fall times with 1000 pF load
- 105 ns (typ) turn-on / 94 ns (typ) turn-off delay times
- Cycle-by-cycle edge-triggered shutdown circuitry
- Extended temperature range: -40 °C to +125 °C

### Applications

- DC-DC Converters
- AC-DC Inverters
- Motor Controls
- Class D Power Amplifiers

### Typical Application

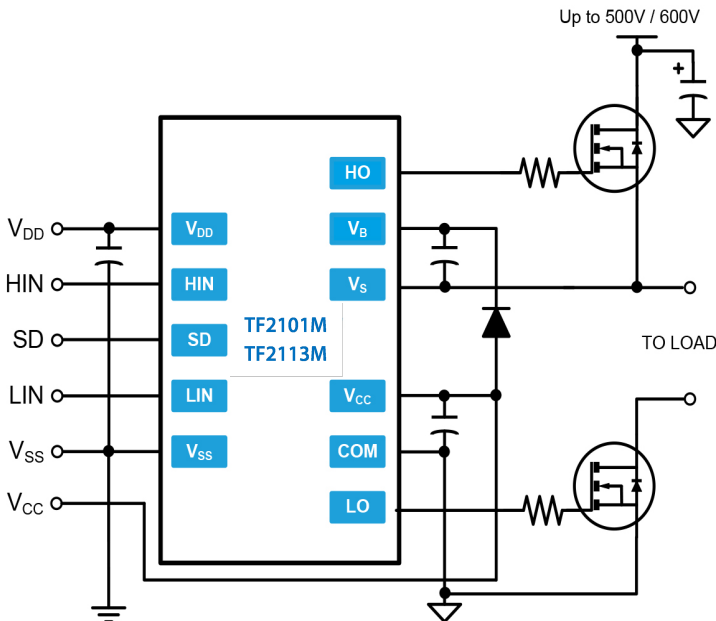

### Description

The TF2110M and TF2113M are high voltage, high-speed MOSFET and IGBT drivers with independent high-side and low-side out- puts. The high-side driver features floating supply for operation at up to 500V / 600V. The 10 ns (max) / 20 ns (max) propagation delay matching between the high and the low side drivers allows high frequency operation.

The TF2110M and TF2113M logic inputs are compatible with standard CMOS levels (as low as 3.3V) while driver outputs feature high pulse current buffers designed for minimum driver cross-conduction.

The TF2110M and TF2113M are offered in 16-pin SOIC wide and 14-pin PDIP packages. They operate over an extended -40 °C to +125 °C temperature range.

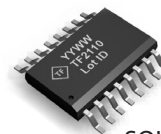

SOIC-16W

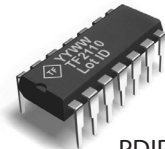

PDIP-14

### Ordering Information

Year Year Week Week

PART NUMBER	PACKAGE	PACK / Qty	MARK
TF2110M-3BS	PDIP-14	Tube / 25	YYWW TF2110 Lot ID
TF2110M-TEU	SOIC-16W	Tube / 45	
TF2110M-TEH	SOIC-16W	T & R / 1500	
TF2113M-3BS	PDIP-14	Tube / 25	YYWW TF2113 Lot ID
TF2113M-TEU	SOIC-16W	Tube / 45	
TF2113M-TEH	SOIC-16W	T & R / 1500	

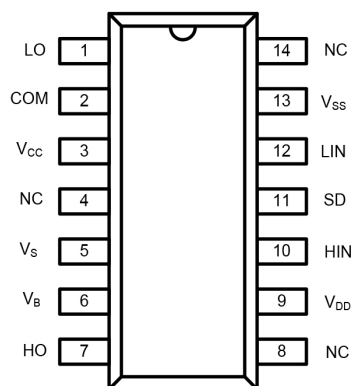

**Top View: PDIP-14  
TF2110M/TF2113M**

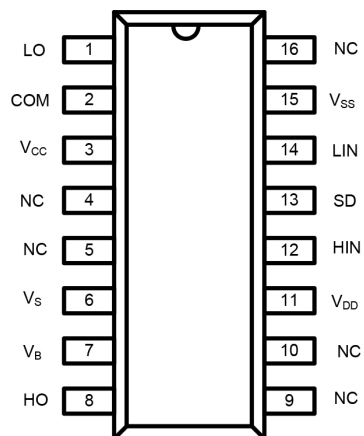

**Top View : SOIC -16 Wide  
TF2110M/TF2113M**

## Pin Descriptions

PIN NAME	PIN DESCRIPTION
$V_{DD}$	Logic power supply pin
HIN	Logic input pin for the high-side gate driver output. HIN and HO are in phase
SD	Logic input shutdown pin
LIN	Logic input pin for the low side gate driver output. LIN and LO are in phase
$V_{SS}$	Logic ground pin
$V_B$	High-side gate driver floating power supply pin
HO	High-side gate driver output pin
$V_S$	High-side gate driver floating power supply return pin
$V_{CC}$	Low-side gate driver power supply pin
LO	Low-side gate driver output pin
COM	Low-side gate driver power supply return pin
NC	"No connect" pin

## Absolute Maximum Ratings (NOTE1)

$V_B$  - High side floating supply voltage (TF2110).....-0.3V to +524V  
 $V_B$  - High side floating supply voltage (TF2113).....-0.3V to +624V  
 $V_S$  - High side floating supply offset voltage.... $V_B$ -24V to  $V_B$ +0.3V  
 $V_{HO}$  - High side floating output voltage..... $V_S$ -0.3V to  $V_B$ +0.3V  
 $dV_S/dt$  - Offset supply voltage transient.....50V/ns

$V_{CC}$  - Low side fixed supply voltage.....-0.3V to +24V  
 $V_{LO}$  - Low side output voltage.....-0.3V to  $V_{CC}$ +0.3V

$V_{DD}$  - Logic supply voltage.....-0.3V to  $V_{SS}$ +24V  
 $V_{SS}$  - Logic supply offset voltage..... $V_{CC}$ -24V to  $V_{CC}$ +0.3V  
 $V_{IN}$  - Logic input voltage (HIN, LIN and SD)... $V_{SS}$ -0.3V to  $V_{DD}$ +0.3V

$P_D$  - Package power dissipation at  $T_A \leq 25^\circ\text{C}$   
 SOIC-16W.....1.25W  
 PDIP-14.....1.6W

**NOTE1** Stresses beyond those listed under "Absolute Maximum Ratings" may cause permanent damage to the device. These are stress ratings only, and functional operation of the device at these or any other conditions beyond those indicated in the operational sections of the specifications is not implied. Exposure to absolute maximum rating conditions for extended periods may affect device reliability.

### SOIC-16W Thermal Resistance (NOTE2)

$\theta_{JC}$ .....45 °C/W  
 $\theta_{JA}$ .....90 °C/W

### PDIP-14 Thermal Resistance (NOTE2)

$\theta_{JC}$ .....35 °C/W  
 $\theta_{JA}$ .....75 °C/W

$T_J$  - Junction temperature.....+150 °C  
 $T_L$  - Lead Temperature (soldering, 10 seconds).....300 °C  
 $T_{STG}$  - Storage temperature .....-55 °C to 150 °C

**NOTE2** When mounted on a standard JEDEC 2-layer FR-4 board.

## Recommended Operating Conditions

Symbol	Parameter	MIN	TYP	MAX	Unit
$V_B$	High side floating supply absolute voltage	$V_S + 10$		$V_S + 20$	V
$V_S$	High side floating supply offset voltage	TF2110	<b>NOTE3</b>	500	V
		TF2113	<b>NOTE3</b>	600	V
$V_{HO}$	High side floating output voltage	$V_S$		$V_B$	V
$V_{CC}$	Low side fixed supply voltage	10		20	V
$V_{LO}$	Low side output voltage	0		$V_{CC}$	V
$V_{DD}$	Logic supply voltage	$V_{SS} + 3$		$V_{SS} + 20$	V
$V_{SS}$	Logic supply offset voltage	-5 ( <b>NOTE 4</b> )		5	V
$V_{IN}$	Logic input voltage (HIN, LIN and SD)	$V_{SS}$		$V_{DD}$	V
$T_A$	Ambient temperature	-40		125	°C

**NOTE 3** Logic operational for  $V_S = -4V$  to +500V. Logic state held for  $V_S = -4V$  to  $-V_{BS}$

**NOTE 4** When  $V_{DD} < 5V$ , the minimum  $V_{SS}$  offset is limited to  $-V_{DD}$

**DC Electrical Characteristics (NOTES)**
 $V_{BIAS} (V_{CC}, V_{BS}, V_{DD}) = 15V, T_A = 25^\circ C$  and  $V_{SS} = COM$ , unless otherwise specified.

Symbol	Parameter	Conditions	MIN	TYP	MAX	Unit
$V_{IH}$	Logic "1" input voltage	<b>NOTE6</b>	9.5			V
$V_{IL}$	Logic "0" input voltage				6.0	V
$V_{OH}$	High level output voltage, $V_{BIAS} - V_O$	$I_O = 0A$			1.4	V
$V_{OL}$	Low level output voltage, $V_O$	$I_O = 20mA$			0.15	V
$I_{LK}$	Offset supply leakage current	$V_B = V_S = 500V/600V$			50	$\mu A$
$I_{BSQ}$	Quiescent $V_{BS}$ supply current	$V_{IN} = 0V$ or $V_{DD}$		55	230	$\mu A$
$I_{CCQ}$	Quiescent $V_{CC}$ supply current	$V_{IN} = 0V$ or $V_{DD}$		56	340	$\mu A$
$I_{DDQ}$	Quiescent $V_{DD}$ supply current	$V_{IN} = 0V$ or $V_{DD}$		0.6	30	$\mu A$
$I_{IN+}$	Logic "1" input bias current	$V_{IN} = V_{DD}$		20	40	$\mu A$
$I_{IN-}$	Logic "0" input bias current	$V_{IN} = 0V$			5.0	$\mu A$
$V_{BSUV+}$	$V_{BS}$ supply under-voltage positive going threshold		7.5	8.6	9.7	V
$V_{BSUV-}$	$V_{BS}$ supply under-voltage negative going threshold		7.0	8.2	9.4	V
$V_{CCUV+}$	$V_{CC}$ supply under-voltage positive going threshold		7.4	8.5	9.6	V
$V_{CCUV-}$	$V_{CC}$ supply under-voltage negative going threshold		7.0	8.2	9.4	V
$I_{O+}$	Output high short circuit pulsed current	$V_O = 0V, V_{IN} = V_{DD}, PW \leq 10 \mu s$	2.0	2.5		A
$I_{O-}$	Output low short circuit pulsed current	$V_O = 15V, V_{IN} = 0V, PW \leq 10 \mu s$	2.0	2.5		A

**NOTE 5** The  $V_{IH}$ ,  $V_{TH}$  and  $I_{IN}$  parameters are referenced to  $V_{SS}$  and are applicable to all three logic input pins: HIN, LIN and SD. The  $V_O$  and  $I_O$  parameters are referenced to COM and are applicable to the respective output pins: HO and LO.

**NOTE 6** For optimal operation, it is recommended that the input pulse (to HIN and LIN) should have an amplitude of 9.5V minimum ( $V_{DD} = 15V$ ) with a pulse width of 200ns minimum

## AC Electrical Characteristics

$V_{BIAS} (V_{CC}, V_{BS}, V_{DD}) = 15V, T_A = 25^\circ C, C_L = 1000pF, \text{ and } V_{SS} = COM, \text{ unless otherwise specified.}$

Symbol	Parameter	Conditions	MIN	TYP	MAX	Unit
$t_{ON}$	Turn-on propagation delay	$V_S = 0V$		105	150	ns
$t_{OFF}$	Turn-off propagation delay	$V_S = 500V/600V$		94	125	ns
$t_{SD}$	Shut down propagation delay	$V_S = 500V/600V$		70	140	ns
$t_r$	Turn-on rise time			15	35	ns
$t_f$	Turn-off fall time			13	25	ns
$t_{DM}$	Delay Matching	TF2110			10	ns
		TF2113			20	ns

## Functional Block Diagram

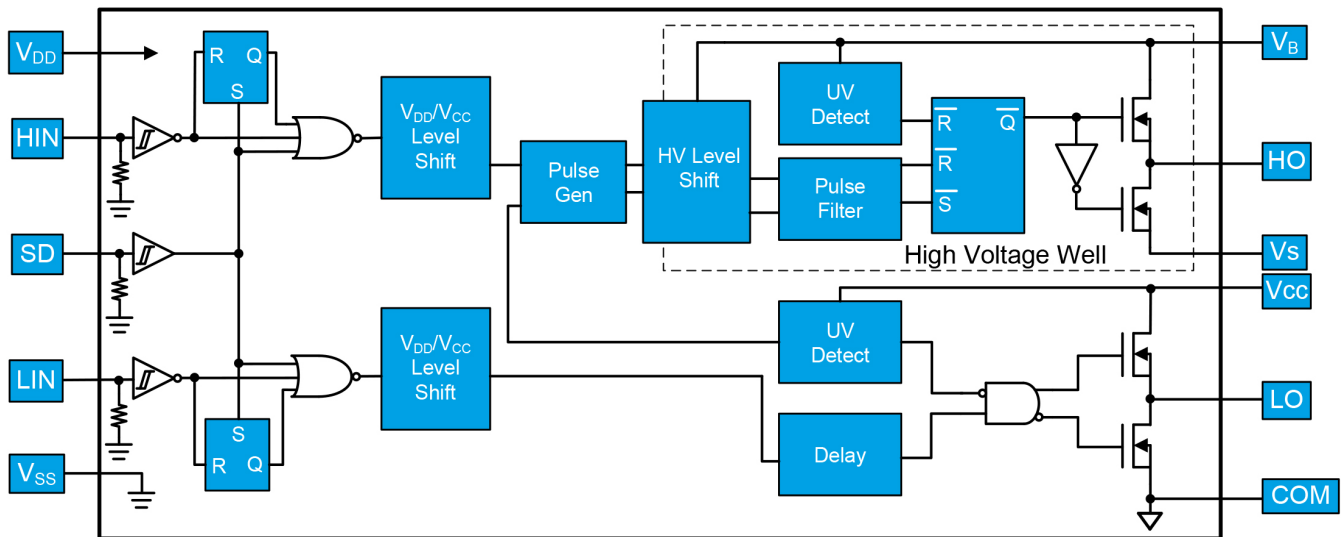

## Timing Waveforms

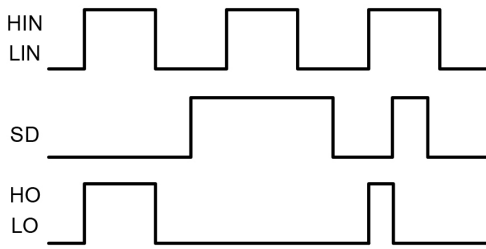

Figure 1. Input / Output Timing Diagram

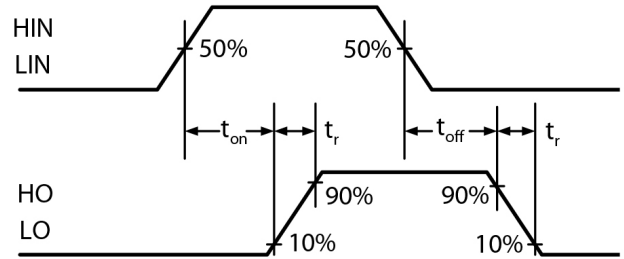

Figure 2. Switching Time Waveform Definitions

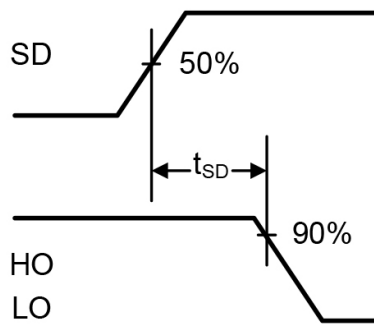

Figure 3. Shutdown Waveform Definitions

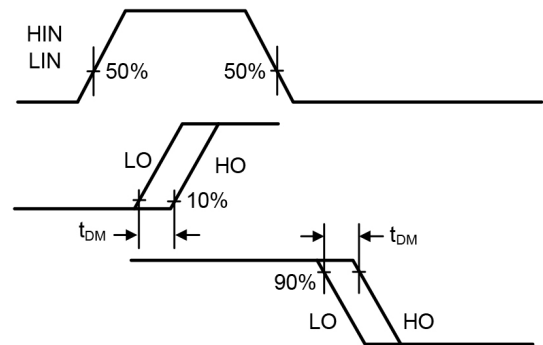

Figure 4. Delay Matching Waveform Definitions

Typical Characteristics

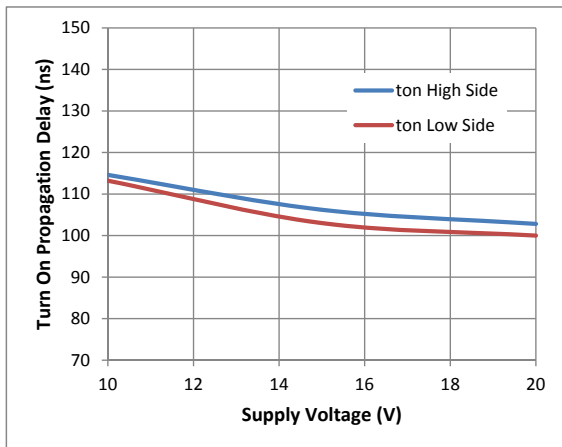

Figure 5. Turn-on Propagation Delay vs. Supply Voltage

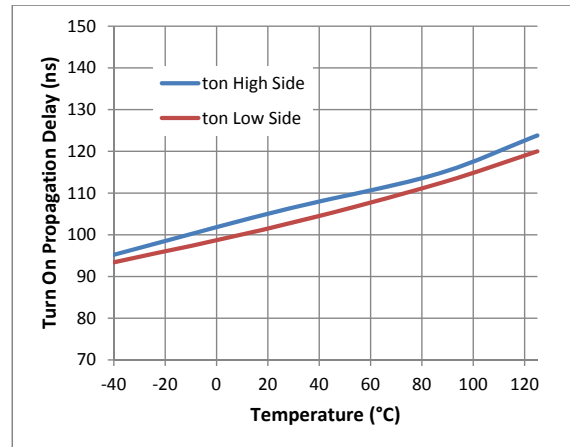

Figure 6. Turn-on Propagation Delay vs. Temperature

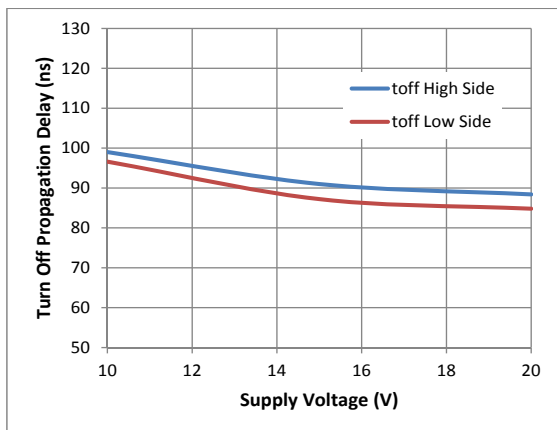

Figure 7. Turn-off Propagation Delay vs. Supply Voltage

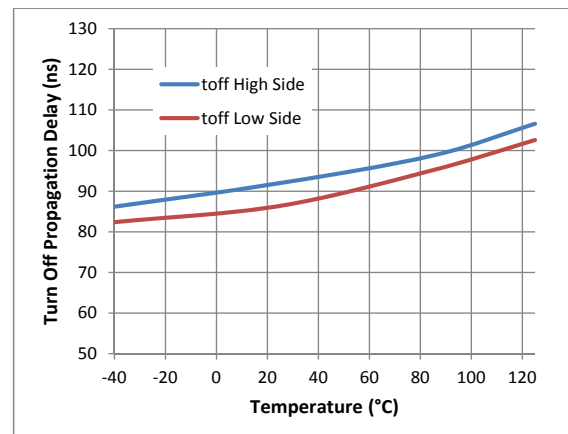

Figure 8. Turn-off Propagation Delay vs. Temperature

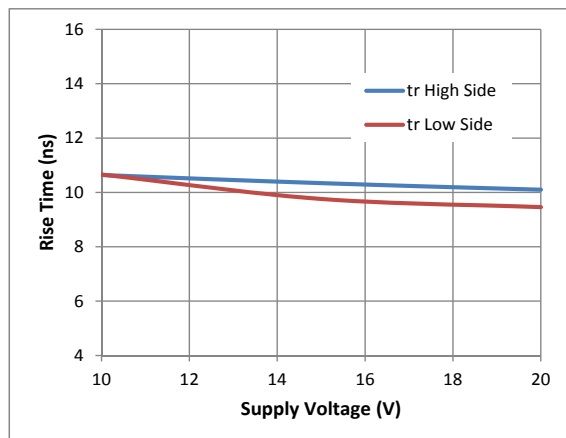

Figure 9. Rise Time vs. Supply Voltage

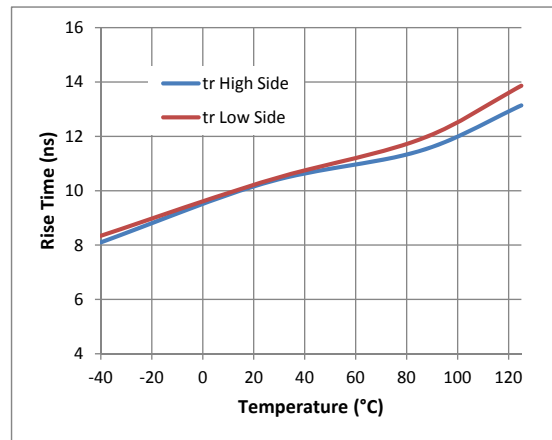

Figure 10. Rise Time vs. Temperature

Typical Characteristics, cont'd

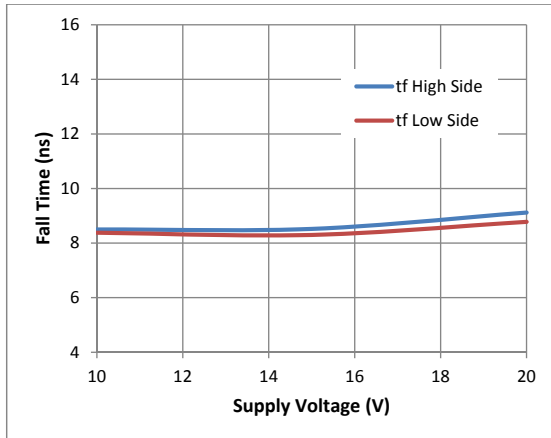

Figure 11. Fall Time vs. Supply Voltage

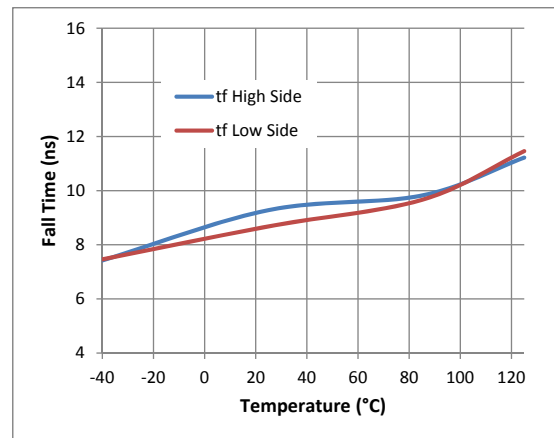

Figure 12. Fall Time vs. Temperature

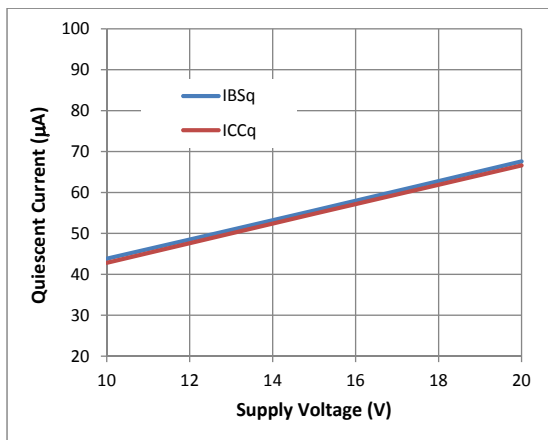

Figure 13. Quiescent Current vs. Supply Voltage

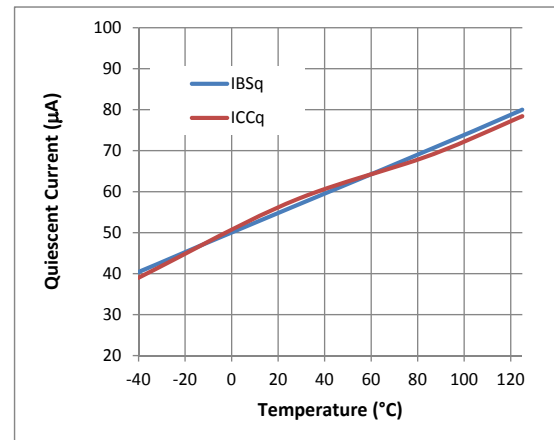

Figure 14. Quiescent Current vs. Temperature

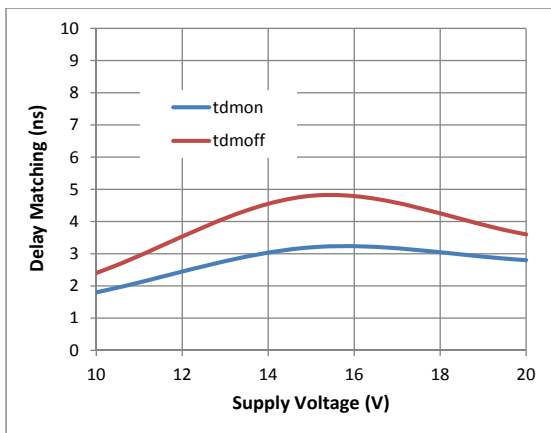

Figure 15. Delay Matching vs. Supply Voltage

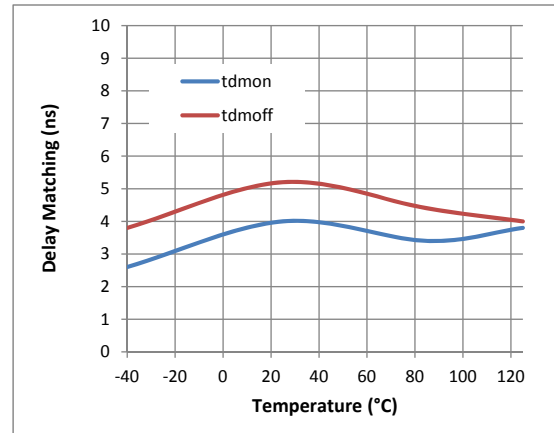

Figure 16. Delay Matching vs. Temperature



Typical Characteristics, cont'd

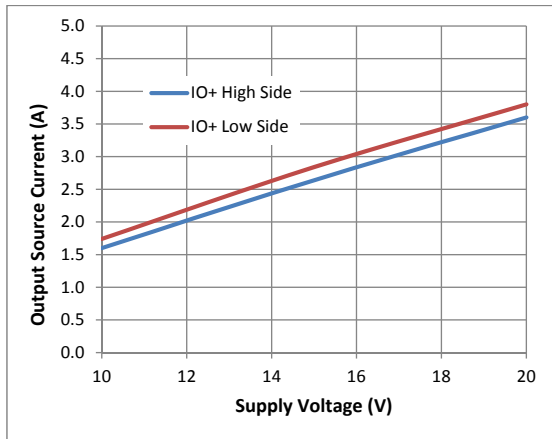

Figure 17. Output Source Current vs. Supply Voltage

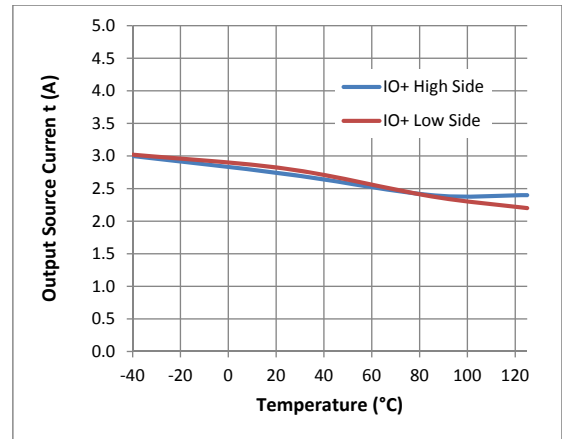

Figure 18. Output Source Current vs. Temperature

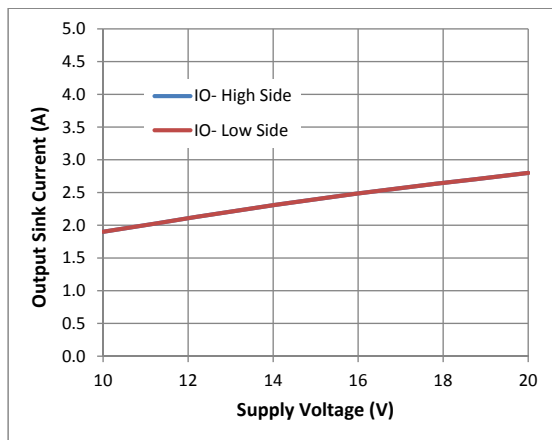

Figure 19. Output Sink Current vs. Supply Voltage

Note: graphs overlap one another

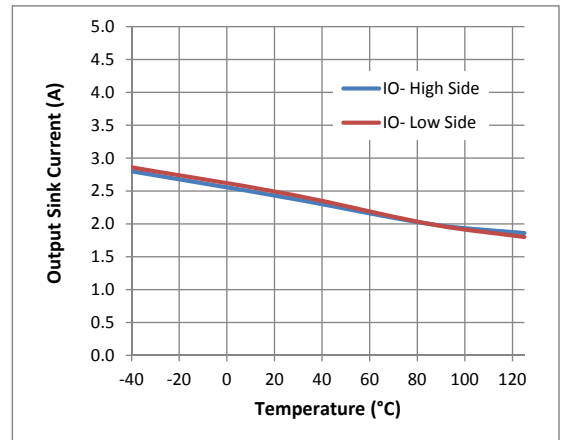

Figure 20. Output Sink Current vs. Temperature

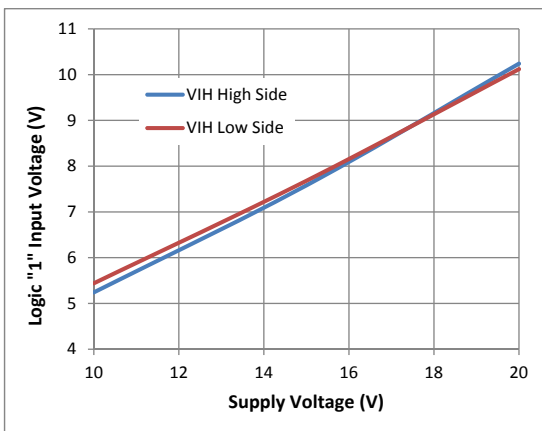

Figure 21. Logic 1 Input Voltage vs. Supply Voltage

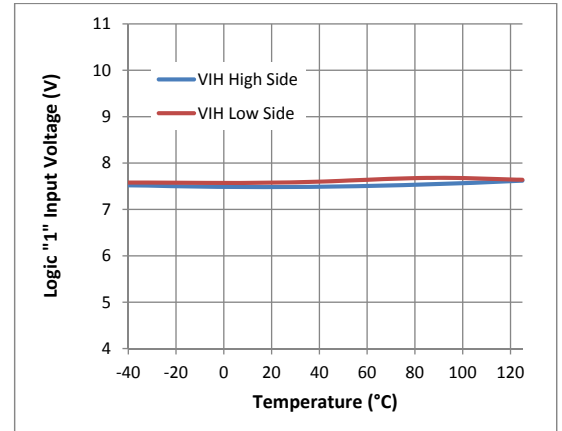

Figure 22. Logic 1 Input Voltage vs. Temperature

Typical Characteristics, cont'd

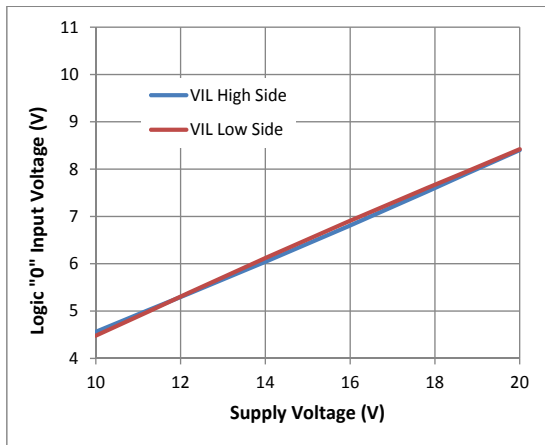

Figure 23. Logic 0 Input Voltage vs. Supply Voltage

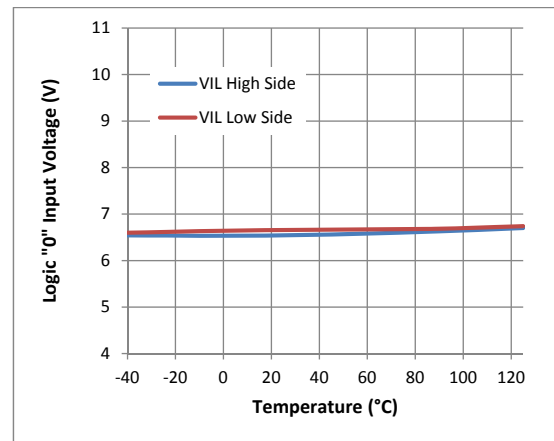

Figure 24. Logic 0 Input Voltage vs. Temperature

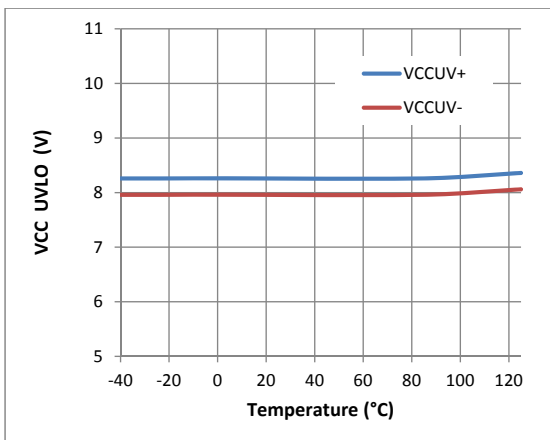

Figure 25.  $V_{CC}$  UVLO vs. Temperature

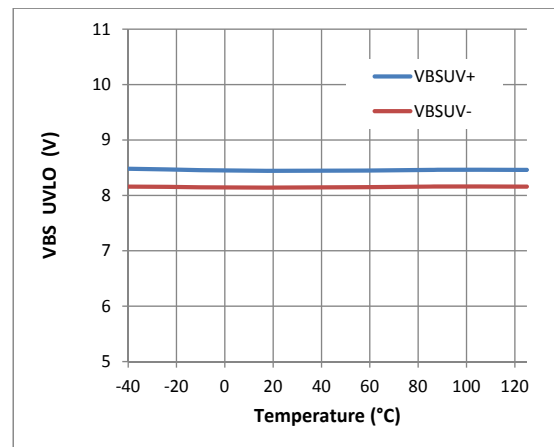

Figure 26.  $V_{BS}$  UVLO vs. Temperature

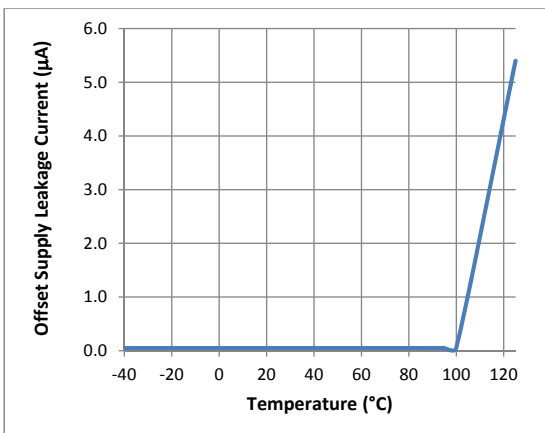

Figure 27. Offset Supply Leakage Current vs. Temperature

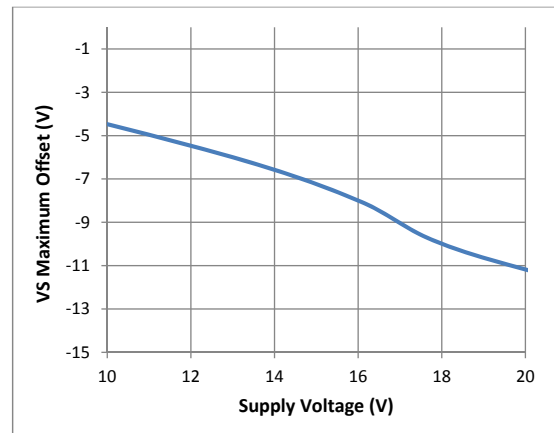

Figure 28.  $V_S$  Maximum Offset vs. Supply Voltage

Typical Characteristics, cont'd

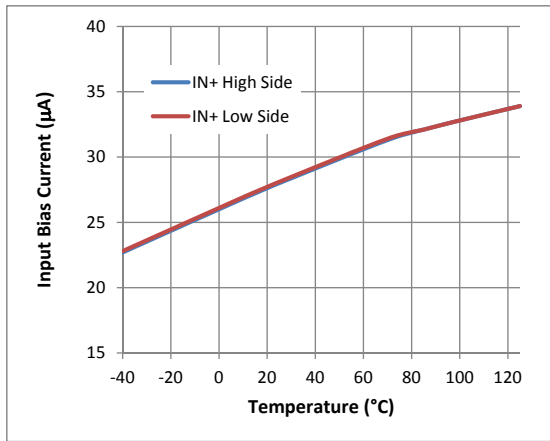

Figure 29. Input Bias Current vs. Temperature

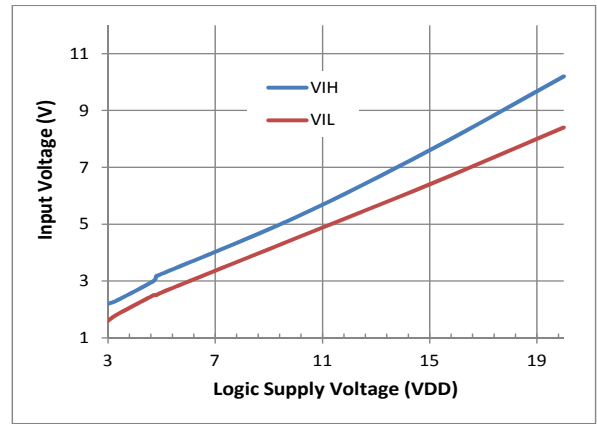
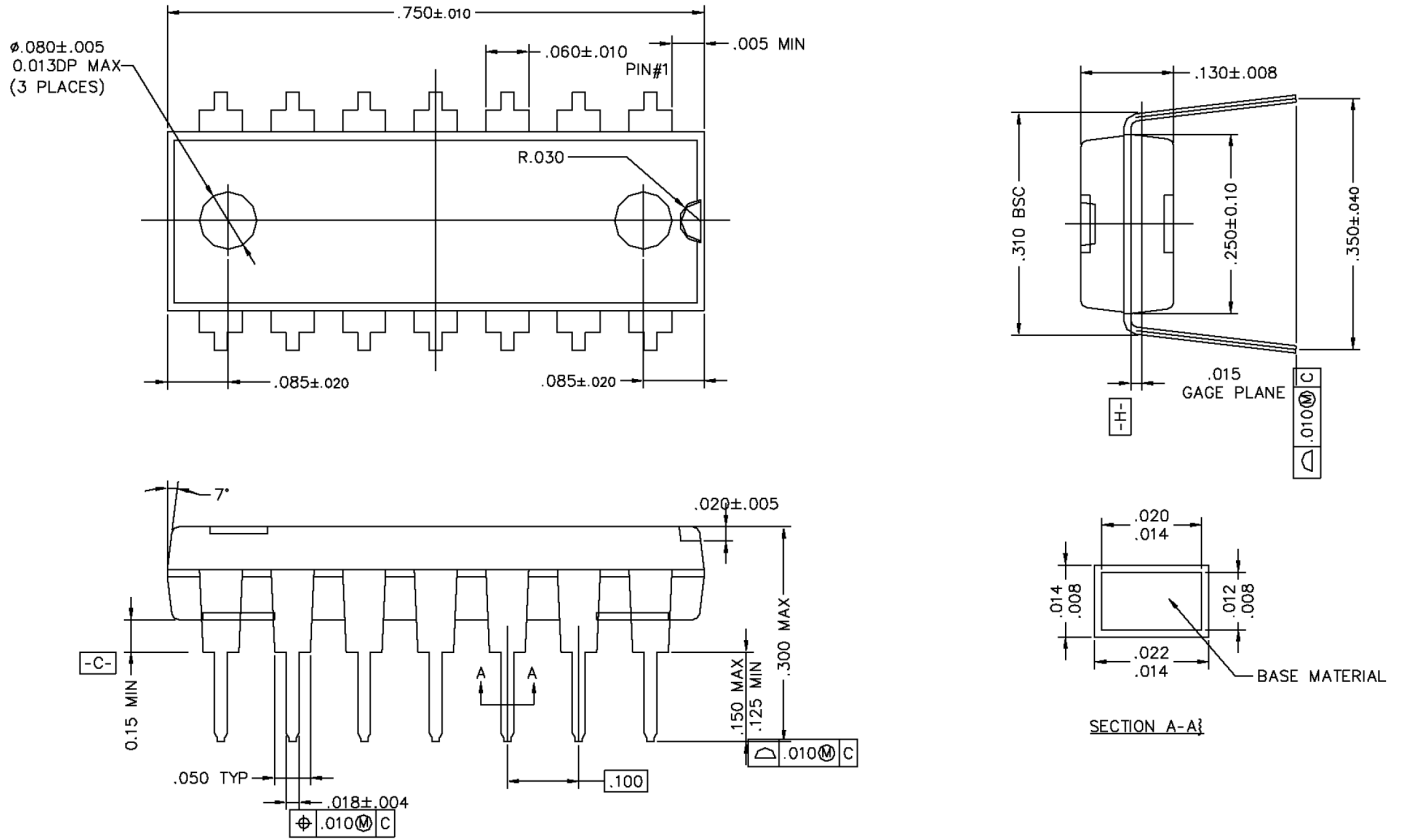

Figure 30. Input Voltage Threshold vs. VDD

Package Dimensions (PDIP-14)

Please contact support@tfsemi.com for package availability.

ALL DIMENSIONS ARE IN INCHES UNLESS OTHERWISE NOTED



Note: Drawing conforms to jedec ref. MS-001 rev D

# Package Dimensions (SOIC-16W)

Please contact support@tfsemi.com for package availability.

ALL DIMENSIONS ARE IN INCHES UNLESS OTHERWISE NOTED

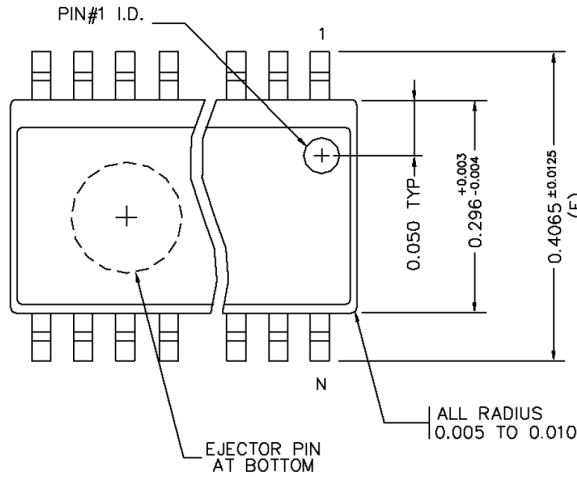

NOTES:

1. "D" and "E" ARE REFERENCE DATUMS AND DO NOT INCLUDE MOLD FLASH OR PROTRUSIONS. MOLD FLASH OR PROTRUSIONS SHALL NOT EXCEED 0.008 INCHES PER SIDE.
2. "N" IS THE NUMBER OF TERMINAL POSITIONS.
3. FORMED LEADS SHALL BE PLANAR WITH RESPECT TO ONE ANOTHER WITHIN 0.003 INCHES (SEATING PLANE) OUTGOING ASSEMBLY & 0.004 INCHES AFTER TEST.
4. DRAWING CONFORMS TO JEDEC REF. MS-013 REV. E

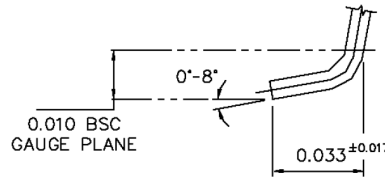

N	D VARIATIONS		
	MIN	NOM	MAX
16	0.398	0.405	0.412
20	0.496	0.503	0.510
24	0.599	0.606	0.613
28	0.697	0.704	0.711

Detail "A"

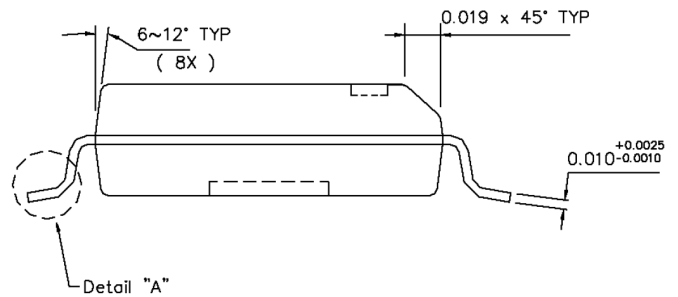
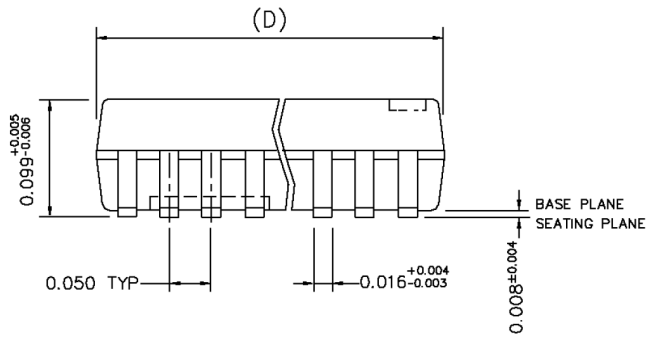

Detail "A"

## Revision History

Rev.	Change	Owner	Date
1.0	First release	Keith Spaulding	6/15/2014
2.0	Fig. 30 added	Keith Spaulding	1/5/2016
2.1	$t_{ON}$ , $t_{OFF}$ , $t_{SD}$ max values changed	Keith Spaulding	2/1/2016
2.2	Text edit	Keith Spaulding	8/30/2017
2.3	Add Note 6	Duke Walton	7/31/2019

## Important Notice

TF Semiconductor Solutions (TFSS) PRODUCTS ARE NEITHER DESIGNED NOR INTENDED FOR USE IN MILITARY AND/OR AEROSPACE, AUTOMOTIVE OR MEDICAL DEVICES OR SYSTEMS UNLESS THE SPECIFIC TFSS PRODUCTS ARE SPECIFICALLY DESIGNATED BY TFSS FOR SUCH USE. BUYERS ACKNOWLEDGE AND AGREE THAT ANY SUCH USE OF TFSS PRODUCTS WHICH TFSS HAS NOT DESIGNATED FOR USE IN MILITARY AND/OR AEROSPACE, AUTOMOTIVE OR MEDICAL DEVICES OR SYSTEMS IS SOLELY AT THE BUYER'S RISK.

TFSS assumes no liability for application assistance or customer product design. Customers are responsible for their products and applications using TFSS products.

Resale of TFSS products or services with statements different from or beyond the parameters stated by TFSS for that product or service voids all express and any implied warranties for the associated TFSS product or service. TFSS is not responsible or liable for any such statements.

©2019 TFSS. All Rights Reserved. Information and data in this document are owned by TFSS wholly and may not be edited, reproduced, or redistributed in any way without the express written consent from TFSS.

For additional information please contact [support@tfsemi.com](mailto:support@tfsemi.com) or visit [www.tfsemi.com](http://www.tfsemi.com)