

**RUILON**

瑞隆源电子



# TVS/ESD Arrays

RLSD32Axx1V Series

**361°** Circuit Protection  
System

Revision:DEC-16

Please refer to <http://www.ruilon.com.cn> for current information.

## TVS/ESD Arrays - RLSD32Axx1V Series

### Features

- 320 Watts Peak Pulse Power per Line (tp = 8/20µs)
- Working voltages:3.3V、 5V、 8V、 12V、 15V、 18V、 24V、 36V
- Low Leakage Current
- Low operating and clamping voltages
- Lead Free/RoHS compliant
- Solid-state silicon avalanche technology
- Provides ESD protection to IEC61000-4-2(ESD):  
±15kV (air discharge)  
±8kV (contact discharge);



### Mechanical Characteristics

- SOD-323 package
- Molding compound flammability rating: UL 94V-0
- Quantity Per Reel :3,000pcs
- Reel Size : 7 inch
- Lead Finish : Lead Free

### Applications

- Cell Phone Handsets and Accessories
- Microprocessor based equipment
- Personal Digital Assistants (PDA's)
- Notebooks, Desktops, and Servers
- Portable Instrumentation
- Pagers Peripherals

### Pinout and Functional Block Diagram

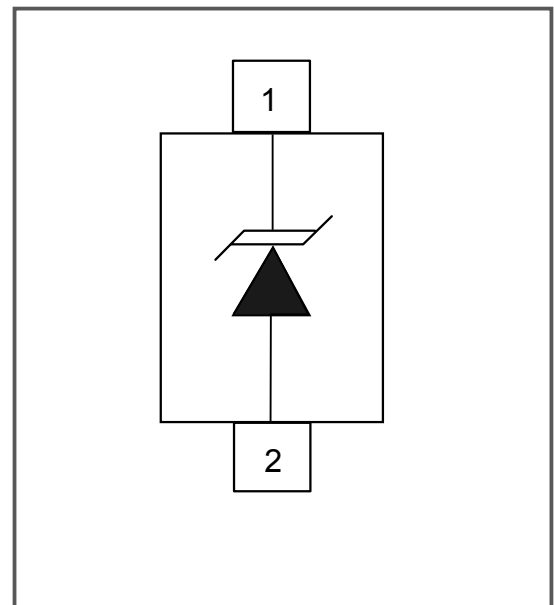

### Part Number Code

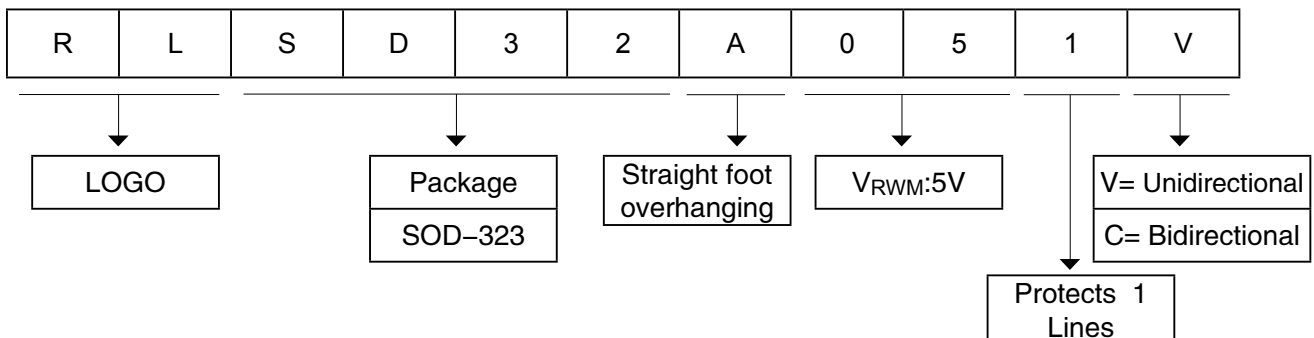

## TVS/ESD Arrays - RLSD32Axx1V Series

### Absolute Maximum Rating

Rating	Symbol	Value	Units
Peak Pulse Power (tp =8/20μs)	P <sub>PK</sub>	320	Watts
ESD Voltage (Contact)	V <sub>ESD</sub>	±8	Kv
ESD Voltage (Air)	V <sub>ESD</sub>	±15	Kv
Lead Soldering Temperature	T <sub>L</sub>	260 (10 sec.)	°C
Operating Temperature	T <sub>J</sub>	-55 to +125	°C
Storage Temperature	T <sub>STG</sub>	-55 to +150	°C

### Electrical Parameters (T=25°C)

Symbol	Parameter
I <sub>PP</sub>	Maximum Reverse Peak Pulse Current
V <sub>C</sub>	Clamping Voltage @ I <sub>PP</sub>
V <sub>RWM</sub>	Working Peak Reverse Voltage
I <sub>R</sub>	Maximum Reverse Leakage Current @ V <sub>RWM</sub>
V <sub>BR</sub>	Breakdown Voltage @ I <sub>T</sub>
I <sub>T</sub>	Test Current
I <sub>F</sub>	Forward Current
V <sub>F</sub>	Forward Voltage @ I <sub>F</sub>

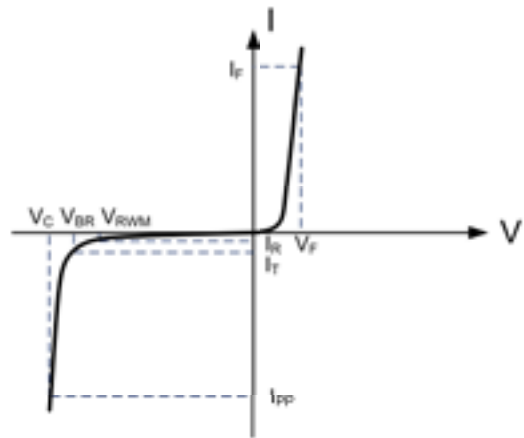

### Electrical Characteristics(@ 25°C Unless Otherwise Specified)

Type Number	Reverse Stand-Off Voltage	Minimum Breakdown Voltage	Peak Pulse Voltage @8/20μS	Peak Pulse Current @8/20μS	Reverse Leakage @V <sub>RWM</sub>	Typical Capacitance
	V <sub>RWM</sub>	V <sub>BR</sub> @1mA	V <sub>C</sub> @1A	I <sub>PP</sub>	I <sub>R</sub> @V <sub>RWM</sub>	C <sub>J</sub> @ 1 MHz
	V	V	V	A	μA	pF
RLSD32A031V	3.3	4	6.5	30	70	200
RLSD32A051V	5	6	9.8	24	1	150
RLSD32A081V	8	8.5	13.4	18	1	125
RLSD32A121V	12	13.3	19	15	1	110
RLSD32A151V	15	16.7	24	12	1	90
RLSD32A181V	18	19	29	10	1	75
RLSD32A241V	24	26.7	43	8	1	35
RLSD32A361V	36	40	60	5	1	25

## TVS/ESD Arrays - RLSD32Axx1V Series

### Characteristic Curves

Fig1. 8/20 $\mu$ s Pulse Waveform

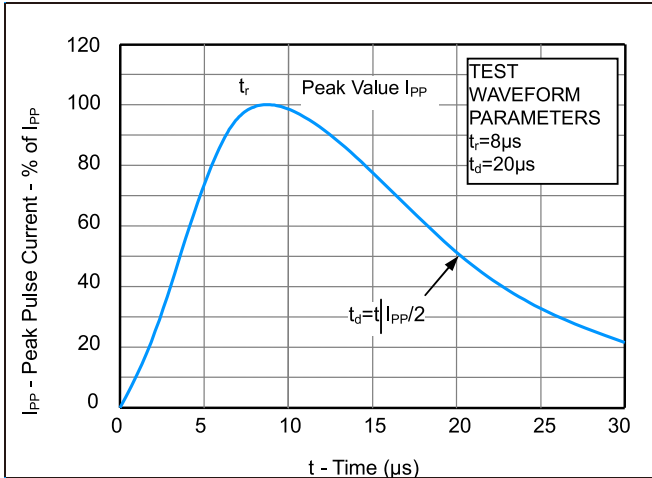

Fig2. ESD Pulse Waveform (according to IEC 61000-4-2)

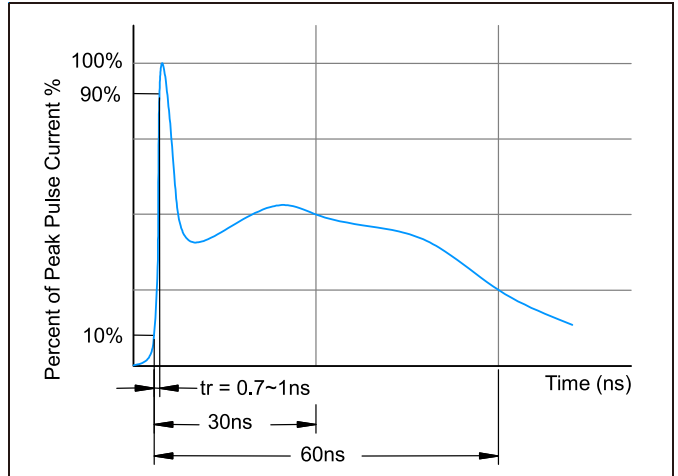

Fig3. Power Derating Curve

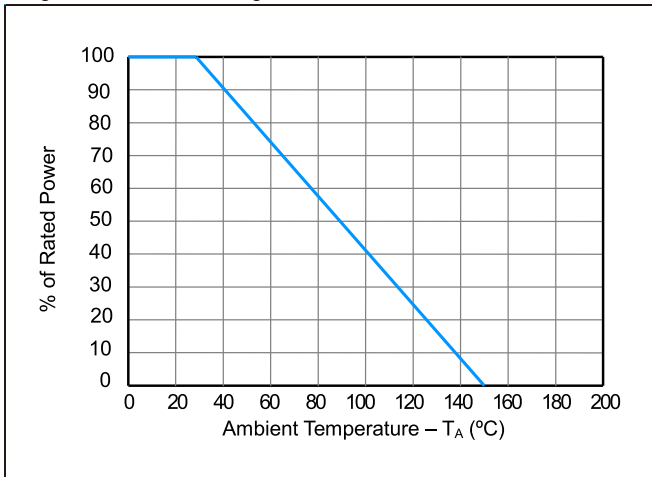
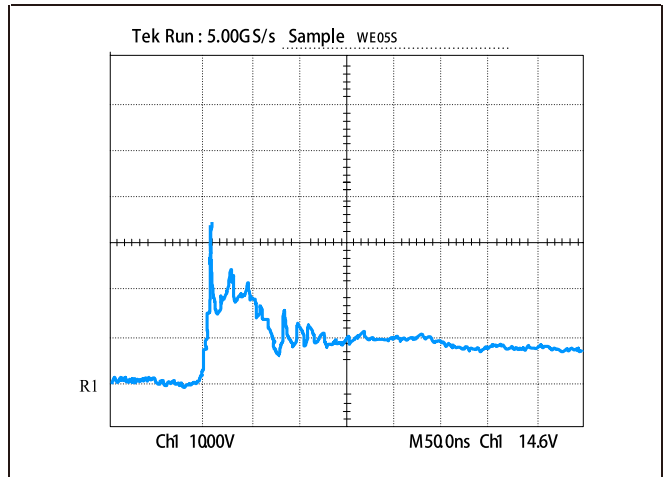
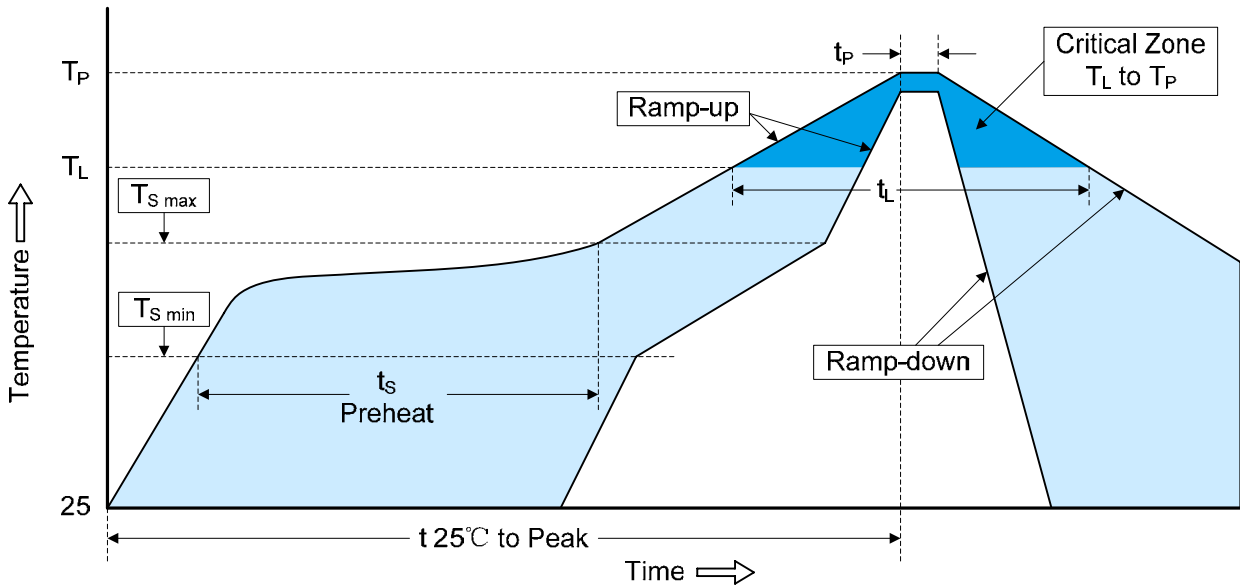

Figure 4: ESD Clamping (8kV Contact per IEC 61000-4-2)



## TVS/ESD Arrays - RLSD32Axx1V Series

### Recommended Soldering Conditions



Profile Feature	Pb-Free Assembly
Average ramp-up rate ( $T_L$ to $T_P$ )	3°C/second max.
Preheat	150°C
-Temperature Min ( $T_{S\ min}$ )	200°C
-Temperature Max ( $T_{S\ max}$ )	60-180 seconds
-Time (min to max) ( $t_s$ )	
$T_{S\ max}$ to $T_L$	3°C/second max.
-Ramp-up Rate	
Time maintained above:	217°C
-Temperature ( $T_L$ )	60-150 seconds
-Time ( $t_L$ )	
Peak Temperature ( $T_P$ )	260°C
Time within 5°C of actual Peak Temperature ( $t_p$ )	20-40 seconds
Ramp-down Rate	6°C/second max.
Time 25°C to Peak Temperature	8 minutes max.

## TVS/ESD Arrays - RLSD32Axx1V Series

### Package dimension SOD-323

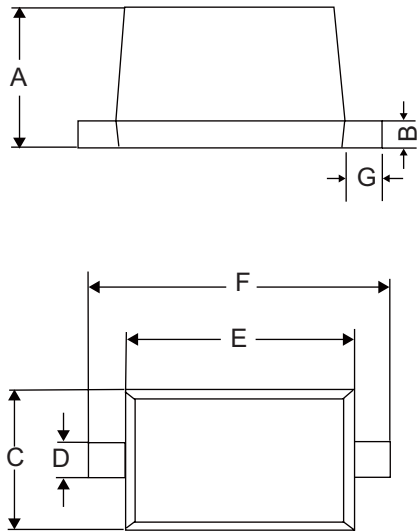

Dimensions				
Symbol	Inches		Millimeters	
	Min	Max	Min	Max
A	---	0.043	---	1.1
B	0.004	0.010	0.10	0.25
C	0.045	0.054	1.2	1.4
D	0.012	0.016	0.3	0.4
E	0.060	0.071	1.5	1.8
F	0.090	0.107	2.3	2.7
G	0.006	0.010	0.15	0.25