



ES2AF THRU ES2JF

SURFACE MOUNT SUPER FAST RECTIFIER

Reverse Voltage - 50 to 1000 Volts Forward Current - 2.0 Amperes

SMAF

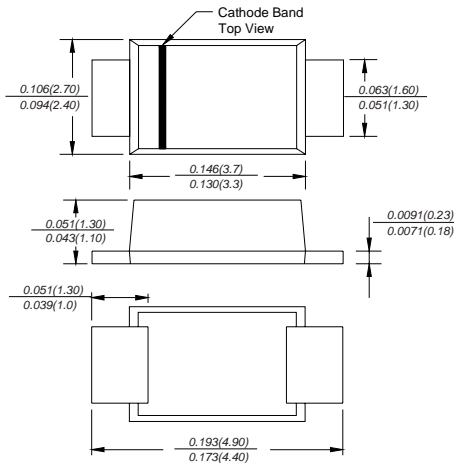

FEATURES

- ◆ The plastic package carries Underwriters Laboratory Flammability Classification 94V-0
- ◆ For surface mounted applications
- ◆ Super fast switching for high efficiency
- ◆ Low reverse leakage
- ◆ Built-in strain relief, ideal for automated placement
- ◆ High forward surge current capability
- ◆ High temperature soldering guaranteed: 260°C/10 seconds at terminals
- ◆ Glass passivated chip junction

MECHANICAL DATA

Case: JEDEC SMAF molded plastic body over passivated chip

Terminals: Solder plated, solderable per MIL-STD-750, Method 2026

Polarity: Color band denotes cathode end

Mounting Position: Any

Weight: 0.0018 ounce, 0.064 grams

MAXIMUM RATINGS AND ELECTRICAL CHARACTERISTICS

Ratings at 25°C ambient temperature unless otherwise specified.

Single phase half-wave 60Hz, resistive or inductive load, for capacitive load current derate by 20%.

MDD Catalog Number	SYMBOLS	ES2AF	ES2BF	ES2CF	ES2DF	ES2EF	ES2GF	ES2JF	UNITS
Maximum repetitive peak reverse voltage	V_{RRM}	50	100	150	200	300	400	600	VOLTS
Maximum RMS voltage	V_{RMS}	35	70	105	140	210	280	420	VOLTS
Maximum DC blocking voltage	V_{DC}	50	100	150	200	300	400	600	VOLTS
Maximum average forward rectified current at $T_L=55^\circ\text{C}$	$I_{(AV)}$	2.0							Amps
Peak forward surge current 8.3ms single half sine-wave superimposed on rated load (JEDEC Method)	I_{FSM}	50.0							Amps
Maximum instantaneous forward voltage at 2.0A	V_F	0.95			1.25		1.7		Volts
Maximum DC reverse current $T_A=25^\circ\text{C}$ at rated DC blocking voltage $T_A=100^\circ\text{C}$	I_R	5.0 50.0							μA
Maximum reverse recovery time (NOTE 1)	t_{rr}	35							ns
Typical junction capacitance (NOTE 2)	C_J	60.0							pF
Typical thermal resistance (NOTE 3)	$R_{\theta JA}$	40.0							$^\circ\text{C/W}$
Operating junction and storage temperature range	T_J, T_{STG}	-50 to +150							$^\circ\text{C}$

- Note:**
1. Reverse recovery condition $I_F=0.5\text{A}, I_R=1.0\text{A}, I_{rr}=0.25\text{A}$
 2. Measured at 1MHz and applied reverse voltage of 4.0V D.C.
 3. P.C.B. mounted with 0.2x0.2" (5.0x5.0mm) copper pad areas



RATINGS AND CHARACTERISTIC CURVES ES2AF THRU ES2JF

AVERAGE FORWARD RECTIFIED CURRENT,
AMPERES

FIG. 1- FORWARD CURRENT DERATING CURVE

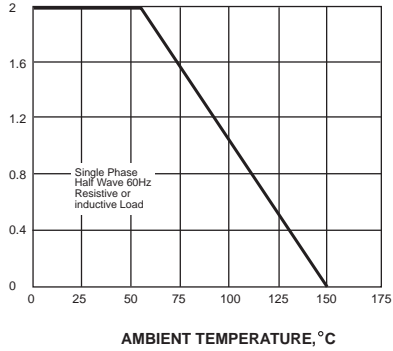

PEAK FORWARD SURGE CURRENT,
AMPERES

FIG. 2-MAXIMUM NON-REPETITIVE PEAK FORWARD SURGE CURRENT

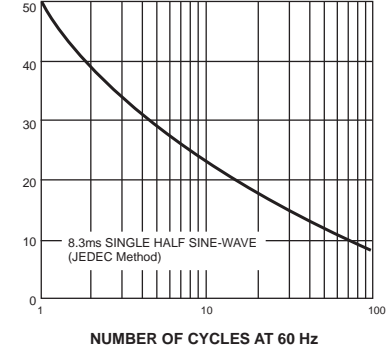

INSTANTANEOUS FORWARD CURRENT, AMPERES

FIG. 3-TYPICAL INSTANTANEOUS FORWARD CHARACTERISTICS

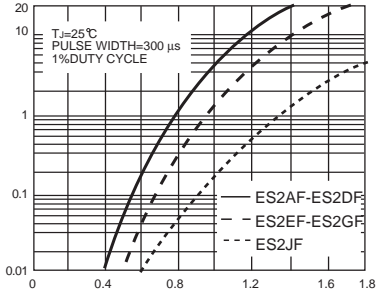

INSTANTANEOUS FORWARD VOLTAGE,
VOLTS

INSTANTANEOUS REVERSE CURRENT,
MICROAMPERES

FIG. 4-TYPICAL REVERSE CHARACTERISTICS

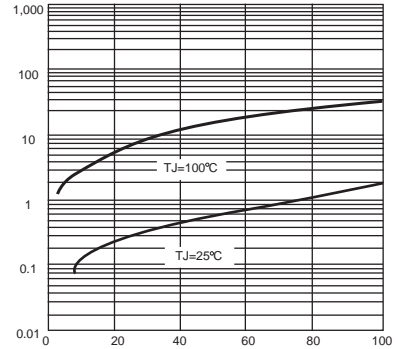

PERCENTAGE OF PEAK REVERSE VOLTAGE, %

JUNCTION CAPACITANCE, pF

FIG. 5-TYPICAL JUNCTION CAPACITANCE

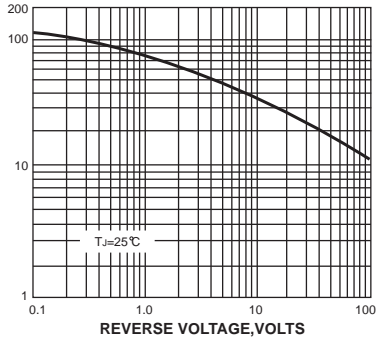

REVERSE VOLTAGE, VOLTS

TRANSIENT THERMAL IMPEDANCE,
°C/W

FIG. 6-TYPICAL TRANSIENT THERMAL IMPEDANCE

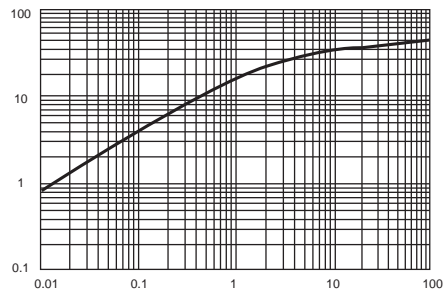

t, PULSE DURATION, sec.

The cruce graph is for reference only, can't be the basis for judgment(曲线图仅供参考!)



www.microdiode.com