



MMBT5551

NPN SILICON TRANSISTOR

HIGH VOLTAGE SWITCHING TRANSISTOR

DESCRIPTION

The UTC **MMBT5551** is a high voltage fast-switching NPN power transistor. It is characterized with high breakdown voltage, high current gain and high switching speed.

FEATURES

- * High Collector-Emitter Voltage: $V_{CE0}=160V$
- * High current gain

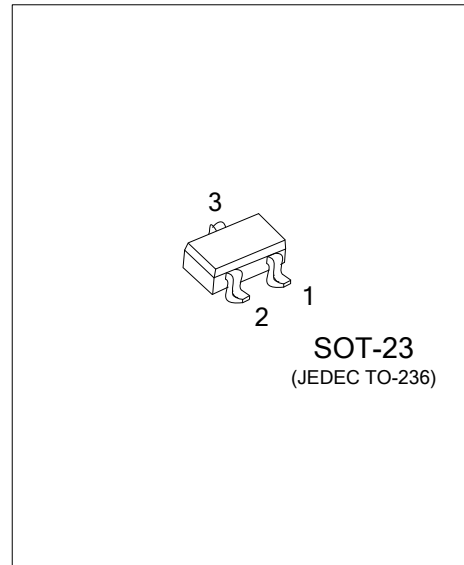

ORDERING INFORMATION

Ordering Number	Package	Pin Assignment			Packing
		1	2	3	
MMBT5551G-x-AE3-R	SOT-23	E	B	C	Tape Reel

Note: Pin Assignment: E: Emitter B: Base C: Collector

<p>MMBT5551G-x-AE3-R</p> <p>(1) Packing Type (2) Package Type (3) Rank (4) Green Package</p>	<p>(1) R: Tape Reel (2) AE3: SOT-23 (3) x: refer to Classification of h_{FE} (4) G: Halogen Free and Lead Free</p>
--	---

MARKING



■ ABSOLUTE MAXIMUM RATINGS ($T_A=25^\circ\text{C}$, unless otherwise specified)

PARAMETER	SYMBOL	RATINGS	UNIT
Collector -Base Voltage	V_{CBO}	180	V
Collector -Emitter Voltage	V_{CEO}	160	V
Emitter -Base Voltage	V_{EBO}	6	V
DC Collector Current	I_C	600	mA
Power Dissipation	P_D	350	mW
Junction Temperature	T_J	+150	$^\circ\text{C}$
Storage Temperature	T_{STG}	-40 ~ +150	$^\circ\text{C}$

Note: Absolute maximum ratings are those values beyond which the device could be permanently damaged. Absolute maximum ratings are stress ratings only and functional device operation is not implied.

■ THERMAL DATA

PARAMETER	SYMBOL	RATINGS	UNIT
Junction to Ambient	θ_{JA}	357	$^\circ\text{C/W}$
Junction to Case	θ_{JC}	104	$^\circ\text{C/W}$

■ ELECTRICAL CHARACTERISTICS ($T_A=25^\circ\text{C}$, unless otherwise specified)

PARAMETER	SYMBOL	TEST CONDITIONS	MIN	TYP	MAX	UNIT
Collector-Base Breakdown Voltage	V_{CBO}	$I_C=100\mu\text{A}$, $I_E=0$	180			V
Collector-Emitter Breakdown Voltage	V_{CEO}	$I_C=1\text{mA}$, $I_B=0$	160			V
Emitter-Base Breakdown Voltage	V_{EBO}	$I_E=10\mu\text{A}$, $I_C=0$	6			V
Collector Cut-off Current	I_{CBO}	$V_{CB}=120\text{V}$, $I_E=0$			50	nA
Emitter Cut-off Current	I_{EBO}	$V_{BE}=4\text{V}$, $I_C=0$			50	nA
DC Current Gain(note)	h_{FE}	$V_{CE}=5\text{V}$, $I_C=1\text{mA}$	80			
		$V_{CE}=5\text{V}$, $I_C=10\text{mA}$	80	160	400	
		$V_{CE}=5\text{V}$, $I_C=50\text{mA}$	80			
Collector-Emitter Saturation Voltage	$V_{CE(SAT)}$	$I_C=10\text{mA}$, $I_B=1\text{mA}$			0.15	V
		$I_C=50\text{mA}$, $I_B=5\text{mA}$			0.2	V
Base-Emitter Saturation Voltage	$V_{BE(SAT)}$	$I_C=10\text{mA}$, $I_B=1\text{mA}$			1	V
		$I_C=50\text{mA}$, $I_B=5\text{mA}$			1	V
Current Gain Bandwidth Product	f_T	$V_{CE}=10\text{V}$, $I_C=10\text{mA}$, $f=100\text{MHz}$	100		300	MHz
Output Capacitance	C_{ob}	$V_{CB}=10\text{V}$, $I_E=0$, $f=1\text{MHz}$			6.0	pF
Noise Figure	NF	$I_C=0.25\text{mA}$, $V_{CE}=5\text{V}$ $R_S=1\text{k}\Omega$, $f=10\text{Hz} \sim 15.7\text{kHz}$			8	dB

Note: Pulse test: $PW < 300\mu\text{s}$, Duty Cycle $< 2\%$

■ CLASSIFICATION OF h_{FE}

RANK	A	B	C
RANGE	80-170	150-240	200-400

■ TYPICAL CHARACTERISTICS

Fig.1 Collector Output Capacitance

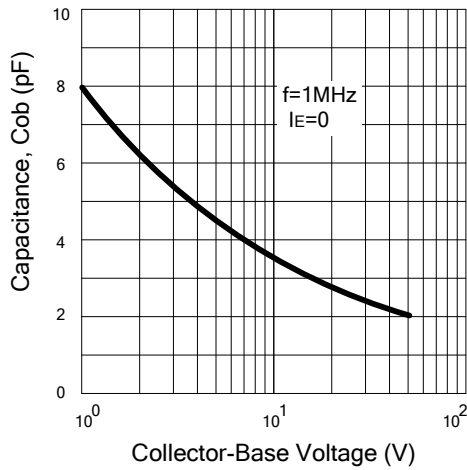

Fig.2 DC Current Gain

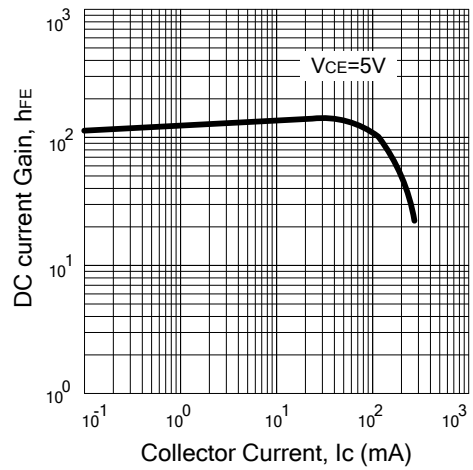

Fig.3 Base-Emitter on Voltage

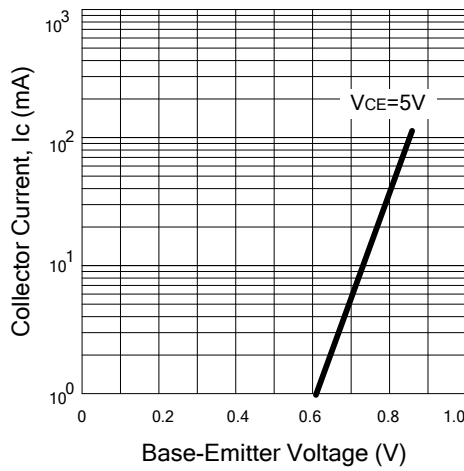

Fig.4 Saturation Voltage

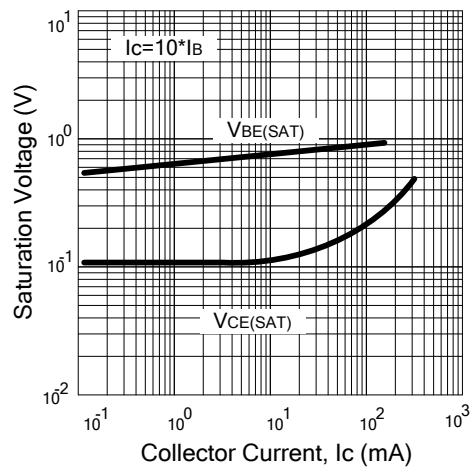
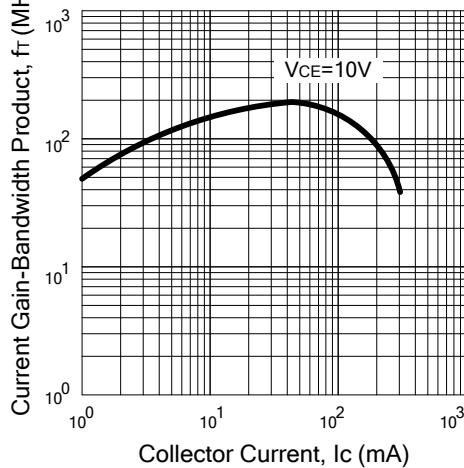
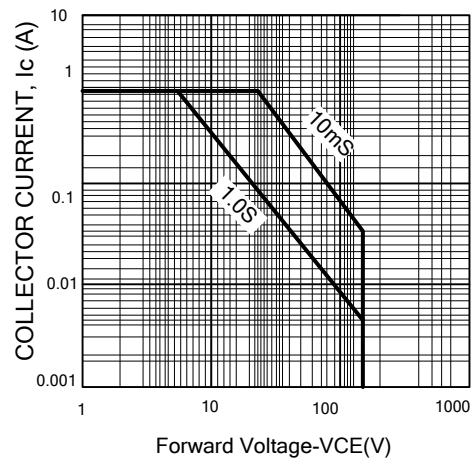

Fig.5 Current Gain-Bandwidth Product



SAFE OPERATING AREA



UTC assumes no responsibility for equipment failures that result from using products at values that exceed, even momentarily, rated values (such as maximum ratings, operating condition ranges, or other parameters) listed in products specifications of any and all UTC products described or contained herein. UTC products are not designed for use in life support appliances, devices or systems where malfunction of these products can be reasonably expected to result in personal injury. Reproduction in whole or in part is prohibited without the prior written consent of the copyright owner. The information presented in this document does not form part of any quotation or contract, is believed to be accurate and reliable and may be changed without notice.