

Description

The PDC2401D5 is a 24V uni-directional TVS diode, utilizing leading monolithic silicon technology to provide fast response time and ultra low ESD clamping voltage, making this device an ideal solution for protecting voltage sensitive data and power line. The PDC2401D5 complies with the IEC 61000-4-2(ESD) with $\pm 30\text{kV}$ air and $\pm 30\text{kV}$ contact discharge. It is assembled into an ultra- small SOD-523 lead-free package. The small size and high ESD surge protection make PDC2401D5 an ideal choice to protect cell phone, digital cameras, audio players and many other portable applications.

Features

- Protects one data or power line
- Ultra low leakage: nA level
- Working voltage: 24V
- Low clamping voltage
- Complies with following standards:
 - IEC 61000-4-2 (ESD) immunity test Air discharge: $\pm 30\text{kV}$
Contact discharge: $\pm 30\text{kV}$
 - IEC61000-4-4 (EFT) 40A (5/50ns)
 - IEC61000-4-5 (Lightning) : 6A(8/20 μs)
- ROHS Compliant

Mechanical Characteristics

- Package: SOD-523
- Lead Finish: Matte Tin
- Case Material: "Green" Molding Compound.
- Moisture Sensitivity: Level 3 per J-STD-020
- Terminal Connections: See Diagram Below
- Marking Information: See Below

Applications

- Peripherals
- Industrial Equipment
- Notebook Computers
- Portable Instrumentation
- Microprocessor Based Equipment
- Cell Phone Handsets and Accessories
- Personal Digital Assistants(PDAs) and Pagers

Dimensions and Pin Configuration

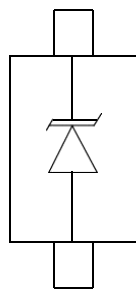
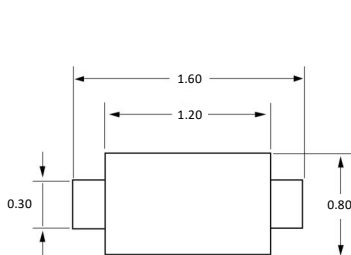

Package Dimensions

Circuit and Pin Schematic

Marking Information

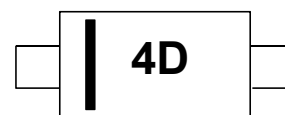

4D = Device Marking Code
Bar denotes Pin1

Ordering Information

Part Number	Marking	Packaging	Reel Size
PDC2401D5	4D	3000/Tape & Reel	7 inch

Absolute Maximum Ratings (TA=25°C unless otherwise specified)

Parameter	Symbol	Value	Unit
Peak Pulse Power (8/20µs)	Ppk	300	W
Peak Pulse Current (8/20µs)	Ipp	6	A
ESD per IEC 61000-4-2 (Air)	VESD	±30	kV
ESD per IEC 61000-4-2 (Contact)		±30	
Operating Temperature Range	TJ	-55 to +125	°C
Storage Temperature Range	Tstg	-55 to +150	°C

Electrical Characteristics (TA=25°C unless otherwise specified)

Parameter	Symbol	Min	Typ	Max	Unit	Test Condition
Reverse Working Voltage	VRWM			24	V	
Breakdown Voltage	VBR	27			V	IT = 1mA
Reverse Leakage Current	IR			0.2	µA	VRWM = 24V
Forward Voltage	VF		1.0	1.2	V	IF = 10mA
Clamping Voltage	VC			33	V	I _{PP} = 1A (8 x 20µs pulse)
Clamping Voltage	VC			50	V	I _{PP} = 6A (8 x 20µs pulse)
Junction Capacitance	CJ			40	pF	VR = 0V, f = 1MHz

Typical Performance Characteristics (TA=25°C unless otherwise Specified)

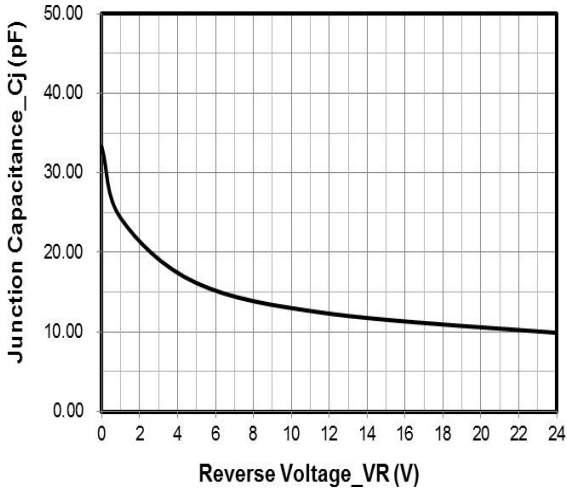

Junction Capacitance vs. Reverse Voltage

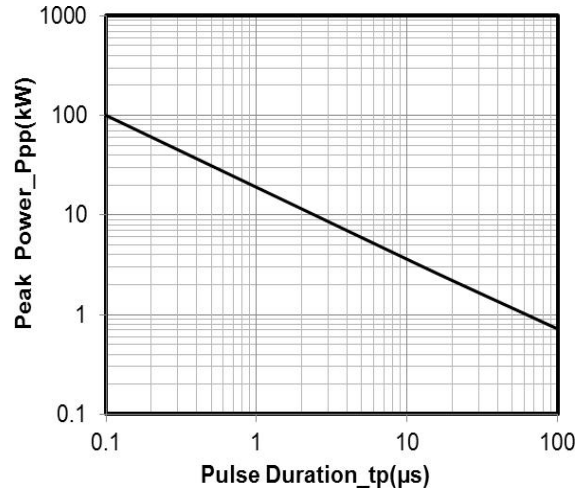

Peak Pulse Power vs. Pulse Time

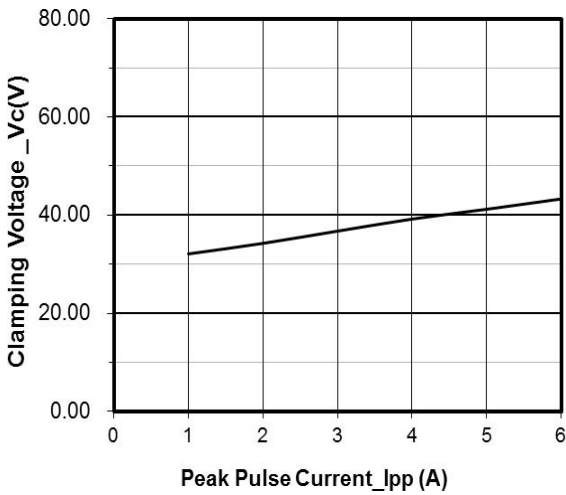

Clamping Voltage vs. Peak Pulse Current

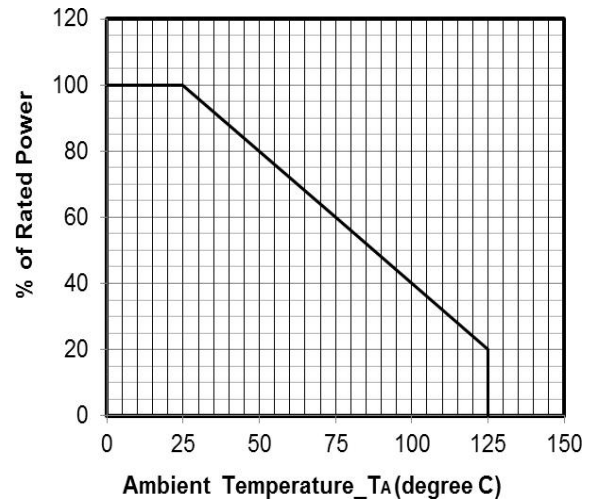

Power Derating Curve

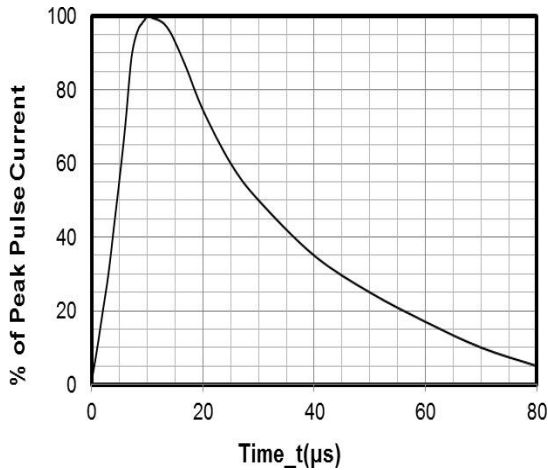

8 X 20μs Pulse Waveform

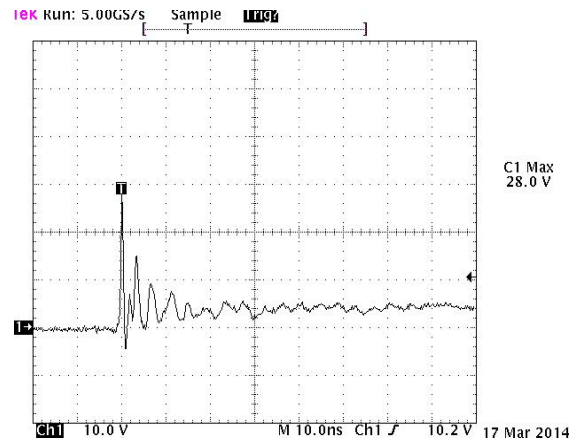

Note: Data is taken with a 10x attenuator

**ESD Clamping Voltage
8 kV Contact per IEC61000-4-2**

SOD-523 Package Outline Drawing

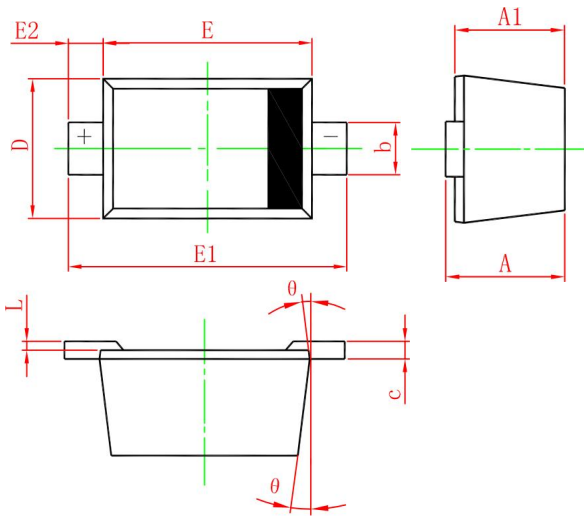

SYM	DIMENSIONS					
	MILLIMETERS			INCHES		
	MIN	NOM	MAX	MIN	NOM	MAX
A	0.51	--	0.77	0.020	--	0.031
A1	0.50	--	0.70	0.020	--	0.028
b	0.25	--	0.35	0.010	--	0.014
c	0.08	--	0.15	0.003	--	0.006
D	0.75	--	0.85	0.030	--	0.033
E	1.10	--	1.30	0.043	--	0.051
E1	1.50	--	1.70	0.059		0.067
E2	0.20REF			0.008REF		
L	0.01	--	0.07	0.001	--	0.003
Θ	7°REF			7°REF		

Suggested Land Pattern

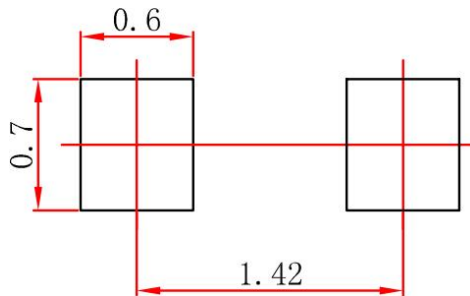

单位 (mm)