

Description

PDLLC12CI a 12V bi-directional TVS diode, utilizing leading monolithic silicon technology to provide fast response time and low ESD clamping voltage, making this device an ideal solution for protecting voltage sensitive high-speed data lines. The PDLLC12CI has a low capacitance with a typical value at 1pF, and complies with the IEC 61000-4-2 (ESD) standard with $\pm 30\text{kV}$ air and $\pm 30\text{kV}$ contact discharge. It is assembled into a lead-free SOD-323 package. The small size, low capacitance and high ESD surge protection make PDLLC12CI an ideal choice to protect cell phone, wireless systems, and communication equipment.

Features

- Ultra low capacitance : 1.0pF typical
- Ultra low leakage: nA level
- Low Operating: 12V
- Low clamping voltage
- Protects one power line or data line
- Complies with following standards:
 - IEC 61000-4-2 (ESD) immunity test Air discharge: $\pm 30\text{kV}$
Contact discharge: $\pm 30\text{kV}$
 - IEC61000-4-4 (EFT) 40A (5/50ns)
- RoHS Compliant

Mechanical Characteristics

- Package: SOD-323
- Lead Finish: Matte Tin
- Case Material: "Green" Molding Compound.
- UL Flammability Classification Rating 94V-0
- Moisture Sensitivity: Level 3 per J-STD-020
- Terminal Connections: See Diagram Below
- Marking Information: See Below

Applications

- USB Ports
- Smart Phones
- Wireless Systems
- Ethernet 10/100/1000 Base T

Dimensions and Pin Configuration

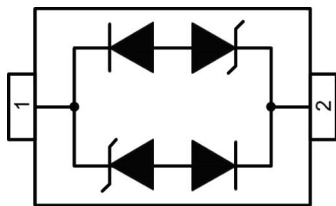

Circuit and Pin Schematic

Marking Information

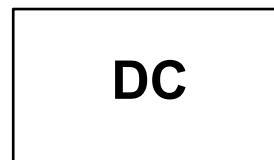

DC = Device Marking Code

Ordering Information

Part Number	Marking	Packaging	Reel Size
PDLLC12CI	DC	3000/Tape & Reel	7 inch

Absolute Maximum Ratings (TA=25°C unless otherwise specified)

Parameter	Symbol	Value	Unit
ESD per IEC 61000-4-2 (Air)	VESD	±30	kV
ESD per IEC 61000-4-2 (Contact)		±30	
Operating Temperature Range	TJ	-40 to +85	°C
Storage Temperature Range	Tstg	-55 to +150	°C

Electrical Characteristics (TA=25°C unless otherwise specified)

Parameter	Symbol	Min	Typ	Max	Unit	Test Condition
Reverse Working Voltage	VRWM			12	V	
Breakdown Voltage	VBR	13.3			V	IT = 1mA
Reverse Leakage Current	IR		1	100	nA	VRWM = 12V
Clamping Voltage	VC			18	V	I _{PP} = 1A (8 x 20µs pulse)
Clamping Voltage	VC			27	V	I _{PP} = 12A (8 x 20µs pulse)
Peak Pulse Current	I _{PP}			12	A	tp=8/20µs
Junction Capacitance	CJ		1.0		pF	VR = 0V, f = 1MHz

Typical Performance Characteristics (TA=25°C unless otherwise Specified)

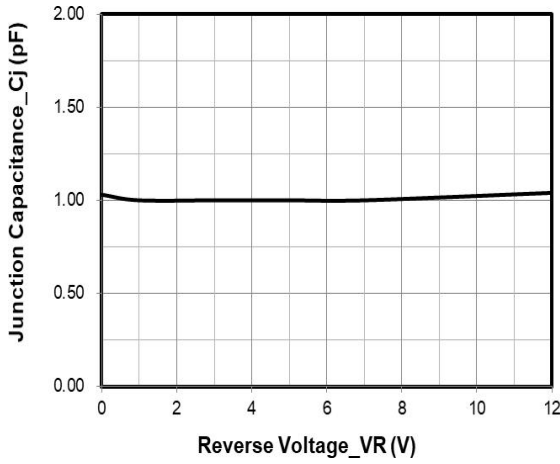

Junction Capacitance vs. Reverse Voltage

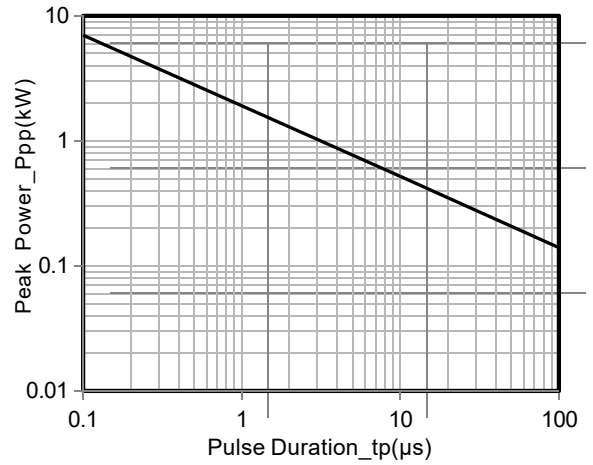

Peak Pulse Power vs. Pulse Time

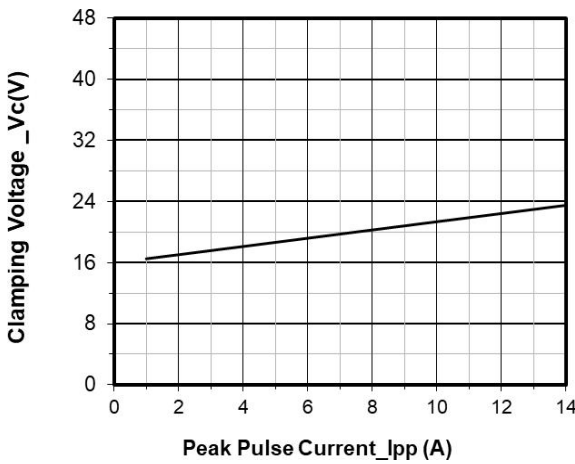

Clamping Voltage vs. Peak Pulse Current

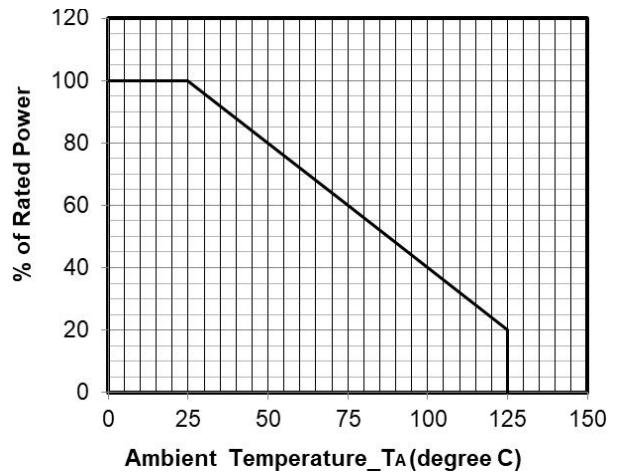

Power Derating Curve

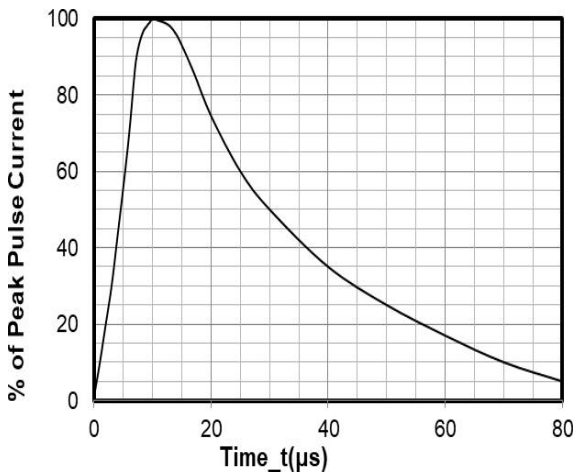

8 X 20μs Pulse Waveform

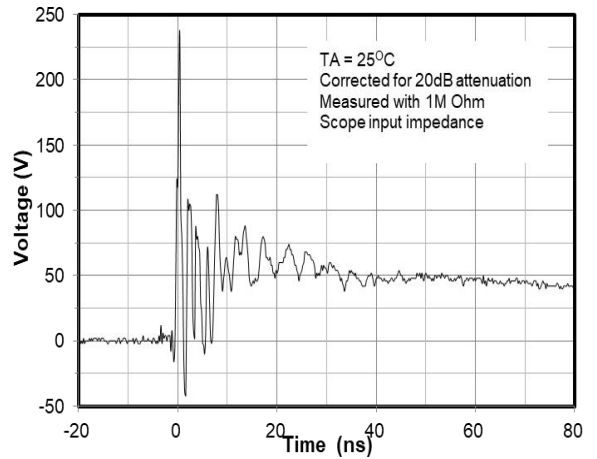

SOD-323 Package Outline Drawing

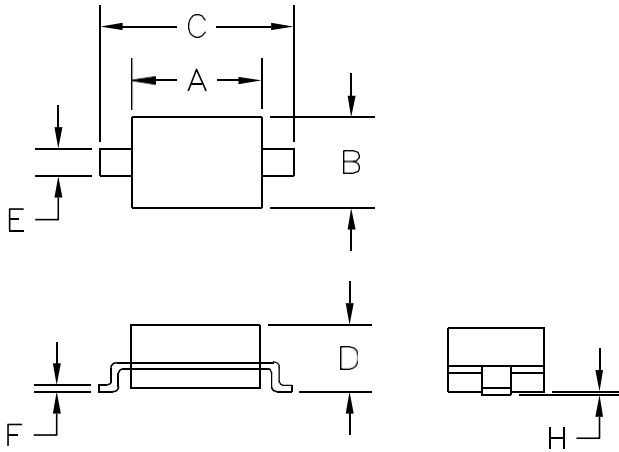

SYM	DIMENSIONS			
	MILLIMETERS		INCHES	
	MIN	MAX	MIN	MAX
A	1.50	1.80	0.060	0.071
B	1.20	1.40	0.045	0.054
C	2.30	2.70	0.090	0.107
D	-	1.10	-	0.043
E	0.30	0.40	0.012	0.016
F	0.10	0.25	0.004	0.010
H	-	0.10	-	0.004

Suggested Land Pattern

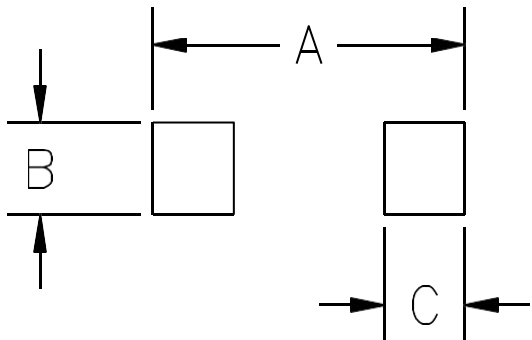

SYM	DIMENSIONS	
	MILLIMETERS	INCHES
A	3.15	0.120
B	0.80	0.031
C	0.80	0.031