

GENERAL DESCRIPTION

The SGM4056 is a low cost battery charger with integrated high input voltage capability for single-cell Li-Ion or Li-polymer batteries.

The SGM4056 features the over-voltage protection (OVP) function. The OVP threshold is typically 6.8V (SGM4056-6.8) or 10.5V (SGM4056-10.5). The SGM4056 accepts a 26.5V maximum voltage for power input, when $V_{IN} > V_{OVP}$, the charger is disabled.

The SGM4056 has a charge indication feature. When charger disabled or the input is floating, the leakage current from the battery is $< 1\mu\text{A}$.

The SGM4056 is available in Green TDFN-3×3-8L, TDFN-2×3-8L, TDFN-2×2-8L and SOIC-8 (Exposed Pad) packages and is rated over the -40°C to +85°C temperature range.

FEATURES

- **Input Over-Voltage Protection Thresholds:**
 - ♦ 6.8V (TYP) for SGM4056-6.8
 - ♦ 10.5V (TYP) for SGM4056-10.5
- **2.55V Trickle Charge Threshold**
- **Power Input Voltage up to 26.5V**
- **Fully Integrated Current Sense and Pass Component**
- **Selectable Charge Current**
- **Selectable EOC Current**
- **Internal Thermal Foldback Function and Thermal Protection**
- **Charging Status Indication**
- **1μA (MAX) Leakage Current When Charger Disabled or Input Floating**
- **Available in Green TDFN-3×3-8L, TDFN-2×3-8L, TDFN-2×2-8L and SOIC-8 (Exposed Pad) Packages**

APPLICATIONS

Handheld Devices
Smart Phones
Portable Internet Devices and Accessory
Standalone Chargers

PACKAGE/ORDERING INFORMATION

MODEL	V _{OVP} (V)	PACKAGE DESCRIPTION	SPECIFIED TEMPERATURE RANGE	ORDER NUMBER	PACKAGE MARKING	PACKING OPTION
SGM4056	6.8V	TDFN-3×3-8L	-40°C to +85°C	SGM4056-6.8YTDB8G/TR	SGM G9DB XXXXX	Tape and Reel, 3000
	6.8V	TDFN-2×3-8L	-40°C to +85°C	SGM4056-6.8YTDC8G/TR	SGB XXXX	Tape and Reel, 3000
	6.8V	TDFN-2×2-8L	-40°C to +85°C	SGM4056-6.8YTDE8G/TR	SG7 XXXX	Tape and Reel, 3000
	6.8V	SOIC-8 (Exposed Pad)	-40°C to +85°C	SGM4056-6.8YPS8G/TR	SGM 4056-6.8YPS8 XXXXX	Tape and Reel, 2500
	10.5V	TDFN-3×3-8L	-40°C to +85°C	SGM4056-10.5YTDB8G/TR	SGM GADB XXXXX	Tape and Reel, 3000
	10.5V	TDFN-2×3-8L	-40°C to +85°C	SGM4056-10.5YTDC8G/TR	SGC XXXX	Tape and Reel, 3000
	10.5V	TDFN-2×2-8L	-40°C to +85°C	SGM4056-10.5YTDE8G/TR	SG8 XXXX	Tape and Reel, 3000
	10.5V	SOIC-8 (Exposed Pad)	-40°C to +85°C	SGM4056-10.5YPS8G/TR	SGM 4056-10.5YPS8 XXXXX	Tape and Reel, 2500

MARKING INFORMATION

NOTE: XXXX = Date Code. XXXXXX = Date Code and Vendor Code.

TDFN-3×3-8L/SOIC-8 (Exposed Pad)

XXXXX

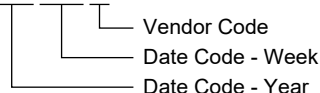

TDFN-2×3-8L/TDFN-2×2-8L

YYY — Serial Number
XXXX



Green (RoHS & HSF): SG Micro Corp defines "Green" to mean Pb-Free (RoHS compatible) and free of halogen substances. If you have additional comments or questions, please contact your SGMICRO representative directly.

ABSOLUTE MAXIMUM RATINGS

VIN to GND	-0.3V to 30V
PPR, CHG, EN, IMIN, IREF, BAT to GND	-0.3V to 6V
Package Thermal Resistance	
TDFN-3×3-8L, θ_{JA}	84°C/W
TDFN-2×3-8L, θ_{JA}	110°C/W
TDFN-2×2-8L, θ_{JA}	118°C/W
SOIC-8 (Exposed Pad), θ_{JA}	58°C/W
Junction Temperature	+150°C
Storage Temperature Range	-65°C to +150°C
Lead Temperature (Soldering, 10s)	+260°C
ESD Susceptibility	
HBM	4000V
MM	200V
CDM	1000V

RECOMMENDED OPERATING CONDITIONS

Operating Temperature Range	-40°C to +85°C
-----------------------------------	----------------

OVERSTRESS CAUTION

Stresses beyond those listed in Absolute Maximum Ratings may cause permanent damage to the device. Exposure to absolute maximum rating conditions for extended periods may affect reliability. Functional operation of the device at any conditions beyond those indicated in the Recommended Operating Conditions section is not implied.

ESD SENSITIVITY CAUTION

This integrated circuit can be damaged by ESD if you don't pay attention to ESD protection. SGMICRO recommends that all integrated circuits be handled with appropriate precautions. Failure to observe proper handling and installation procedures can cause damage. ESD damage can range from subtle performance degradation to complete device failure. Precision integrated circuits may be more susceptible to damage because very small parametric changes could cause the device not to meet its published specifications.

DISCLAIMER

SG Micro Corp reserves the right to make any change in circuit design, or specifications without prior notice.

PIN CONFIGURATIONS

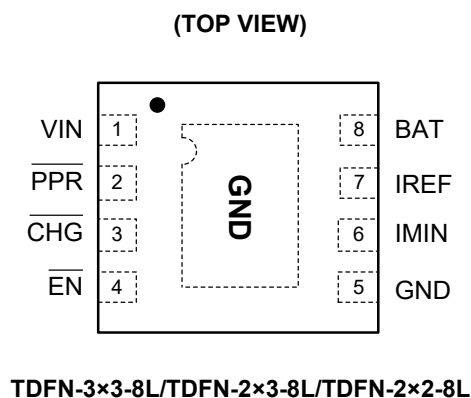
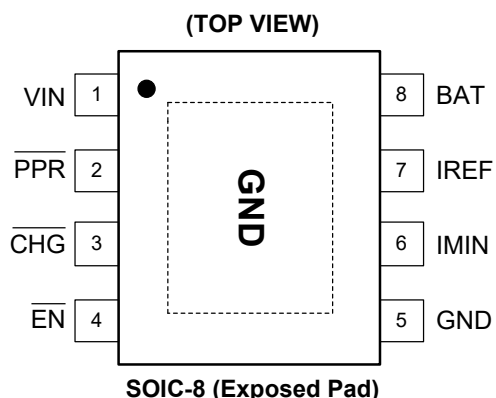

PIN DESCRIPTION

PIN	NAME	FUNCTION
1	VIN	Power Input Pin.
2	$\overline{\text{PPR}}$	Open-Drain Power Presence Indication Pin.
3	$\overline{\text{CHG}}$	Open-Drain Charge Indication Pin.
4	$\overline{\text{EN}}$	Enable Input Pin.
5	GND	Ground.
6	IMIN	End-of-Charge (EOC) Current Programming Pin.
7	IREF	Charge-Current Programming and Monitoring Pin.
8	BAT	Charger Output Pin.
Exposed Pad	GND	Exposed Pad. Thermal pad is internally grounded and must be connected to the PCB GND plane.

ELECTRICAL CHARACTERISTICS

(V_{IN} = 5V, R_{IMIN} = 243kΩ, T_A = +25°C, unless otherwise noted.)

PARAMETER		SYMBOL	CONDITIONS	MIN	TYP	MAX	UNITS
Recommended Operating Conditions							
Maximum Supply Voltage						26.5	V
Operating Supply Voltage	SGM4056-6.8			4.55		6.10	V
	SGM4056-10.5			4.55		9.35	
Programmed Charge Current				100		900	mA
Power-On Reset							
Rising POR Threshold		V _{POR}	V _{BAT} = 3.0V, R _{IREF} = 120kΩ, use $\overline{\text{PPR}}$ to indicate the comparator output.	3.21	3.95	4.55	V
Falling POR Threshold		V _{POR}		2.86	3.60	4.35	V
VIN-BAT Offset Voltage							
Rising Edge		V _{OS}	V _{BAT} = 4.5V, R _{IREF} = 120kΩ, use $\overline{\text{PPR}}$ pin to indicate the comparator output. ⁽¹⁾		110	200	mV
Falling Edge		V _{OS}		5	60		mV
Over-Voltage Protection							
Over-Voltage Protection Threshold	SGM4056-6.8	V _{OV_P}	V _{BAT} = 4.3V, R _{IREF} = 120kΩ, use $\overline{\text{PPR}}$ to indicate the comparator output.	6.10	6.80	7.26	V
	SGM4056-10.5			9.35	10.50	11.15	
OVP Threshold Hysteresis	SGM4056-6.8	V _{OV_{PHYS}}		140	220	300	mV
	SGM4056-10.5			245	340	430	
Standby Current							
BAT Pin Sink Current		I _{STANDBY}	Charger disabled or the input is floating			1	μA
VIN Pin Supply Current		I _{VIN}	V _{BAT} = 4.3V, R _{IREF} = 24.3kΩ, charger disabled		200	275	μA
VIN Pin Supply Current		I _{VIN}	V _{BAT} = 4.3V, R _{IREF} = 24.3kΩ, charger enabled		270	320	μA
Voltage Regulation							
Output Voltage	V _{CH}	R _{IREF} = 24.3kΩ, 4.55V < V _{IN} < 6.10V, charge current = 20mA	4.152	4.2	4.248	V	
		R _{IREF} = 24.3kΩ, 4.55V < V _{IN} < 9.35V, charge current = 20mA	4.152	4.2	4.248		
PMOS On Resistance		R _{DS(ON)}	V _{BAT} = 3.8V, charge current = 500mA, R _{IREF} = 10kΩ		0.7		Ω
Charge Current ⁽²⁾							
IREF Pin Output Voltage		V _{IREF}	V _{BAT} = 3.8V, R _{IREF} = 120kΩ	1.162	1.215	1.262	V
Constant Charge Current		I _{REF}	R _{IREF} = 24.3kΩ, V _{BAT} = 2.8V to 3.8V	440	500	560	mA
Trickle Charge Current		I _{TRK}	R _{IREF} = 24.3kΩ, V _{BAT} = 2.4V	55	90	135	mA
End-of-Charge Current		I _{MIN}	R _{IREF} = 24.3kΩ	20	40	75	mA
EOC Rising Threshold			R _{IREF} = 24.3kΩ	315	370	435	mA
Preconditioning Charge Threshold							
Preconditioning Charge Threshold Voltage		V _{MIN}	R _{IREF} = 24.3kΩ	2.46	2.55	2.65	V
Preconditioning Voltage Hysteresis		V _{MINHYS}	R _{IREF} = 24.3kΩ	20	100	190	mV

NOTES:

- The 4.5V V_{BAT} is selected so that the $\overline{\text{PPR}}$ output can be used as the indication for the offset comparator output indication. If the V_{BAT} is lower than the POR threshold, no output pin can be used for indication.
- The charge current can be affected by the thermal foldback function if the IC under the test setup cannot dissipate the heat.

ELECTRICAL CHARACTERISTICS (continued)(V_{IN} = 5V, R_{IMIN} = 243kΩ, T_A = +25°C, unless otherwise noted.)

PARAMETER	SYMBOL	CONDITIONS	MIN	TYP	MAX	UNITS
Internal Temperature Monitoring						
Charge Current Foldback Threshold	T _{FOLD}			115		°C
Logic Input and Outputs						
$\overline{\text{EN}}$ Pin Logic Input High			1.5			V
$\overline{\text{EN}}$ Pin Logic Input Low					0.8	V
$\overline{\text{EN}}$ Pin Internal Pull Down Resistance			150	200	250	kΩ
$\overline{\text{CHG}}$ Sink Current when LOW		Pin Voltage = 1V	15	24		mA
$\overline{\text{CHG}}$ Leakage Current when High Impedance		V _{$\overline{\text{CHG}}$} = 5.5V			4.5	μA
$\overline{\text{PPR}}$ Sink Current when LOW		Pin Voltage = 1V	15	24		mA
$\overline{\text{PPR}}$ Leakage Current when High Impedance		V _{$\overline{\text{PPR}}$} = 5.5V			4.5	μA

TYPICAL PERFORMANCE CHARACTERISTICS

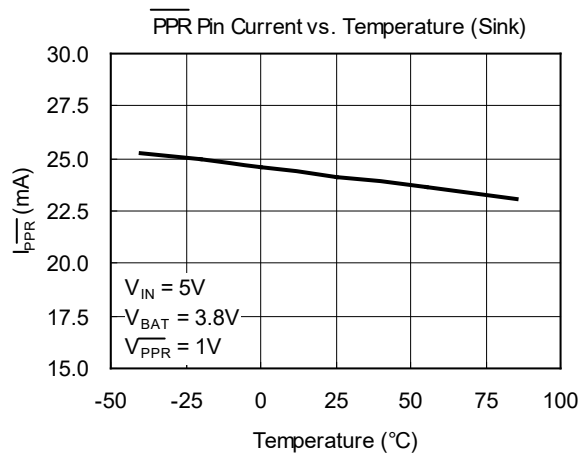
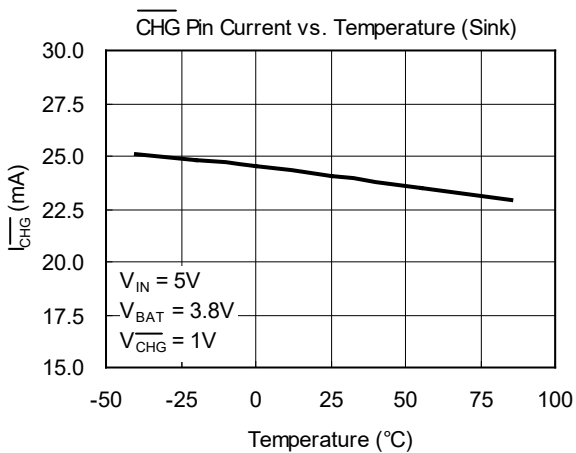
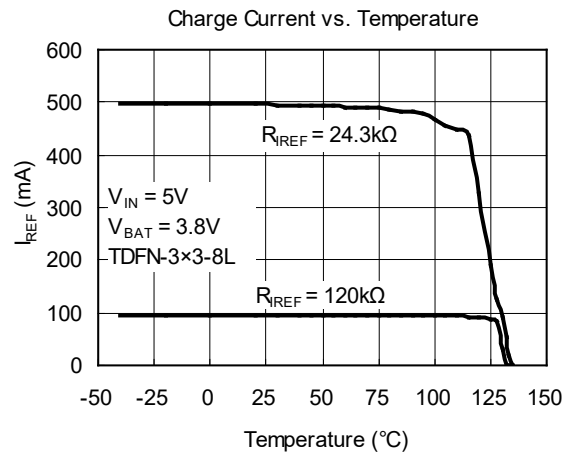
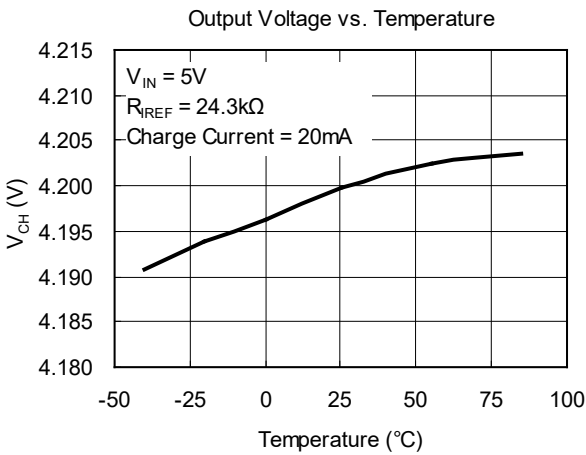
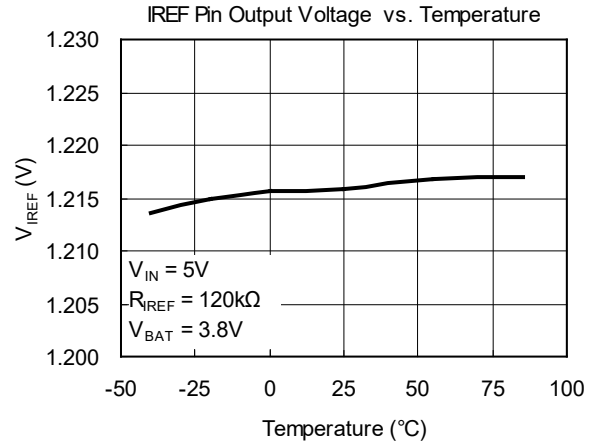
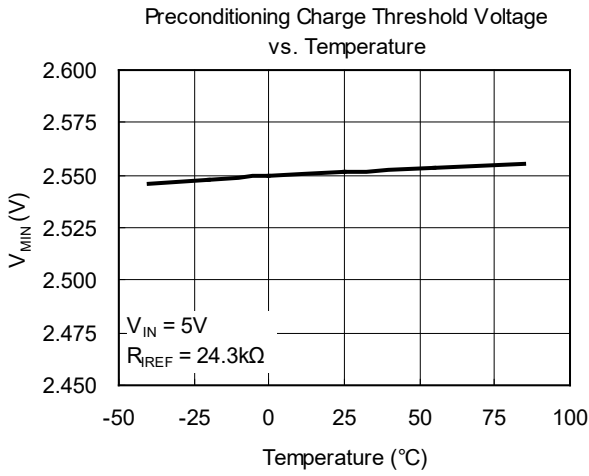

TYPICAL PERFORMANCE CHARACTERISTICS (continued)

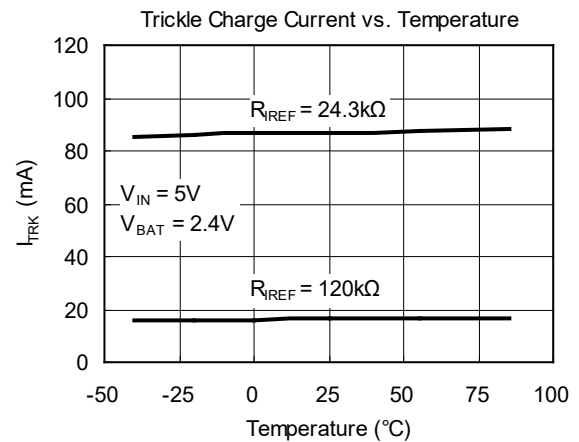
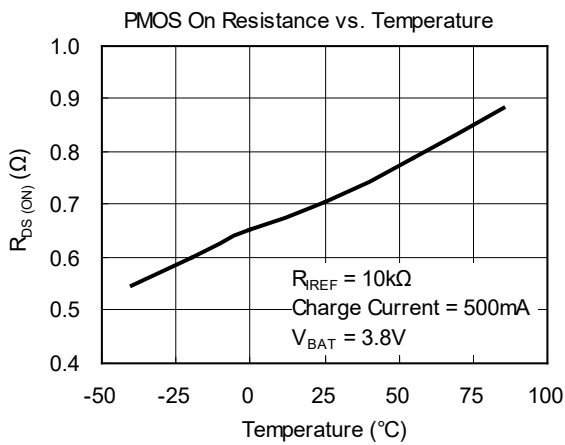
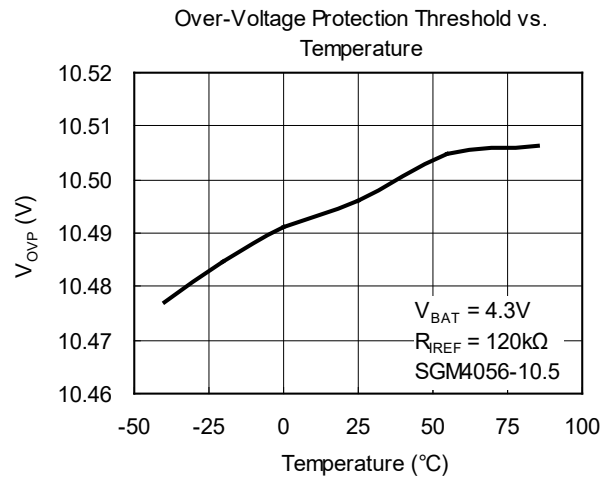
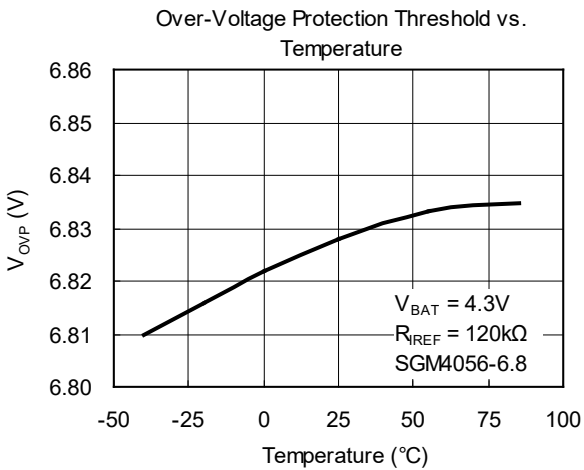
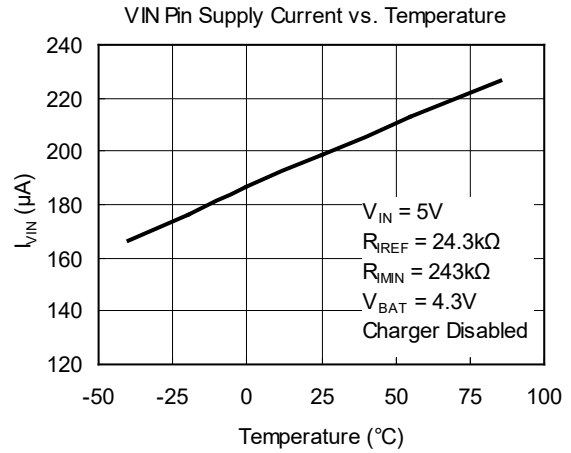
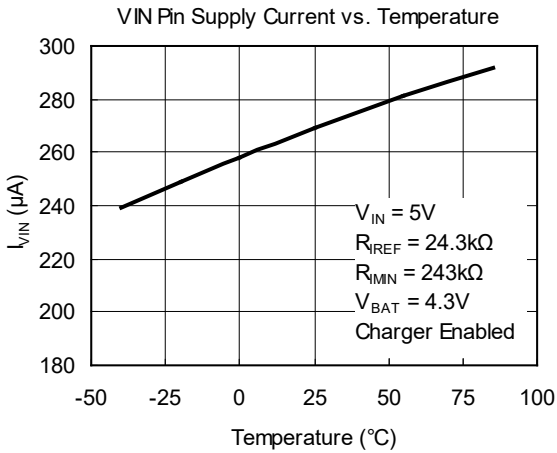

TYPICAL PERFORMANCE CHARACTERISTICS (continued)

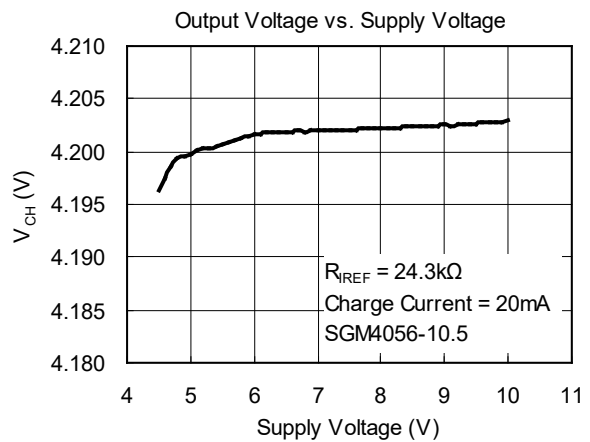
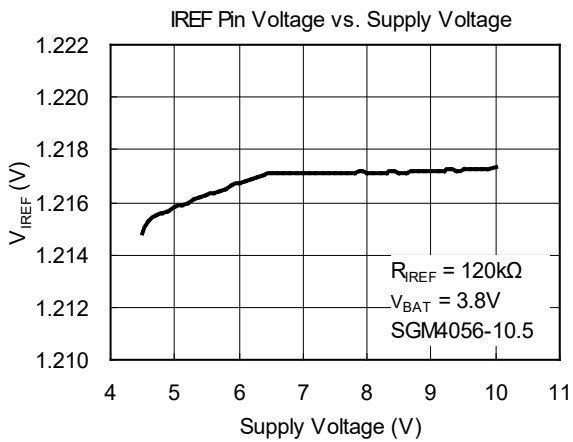
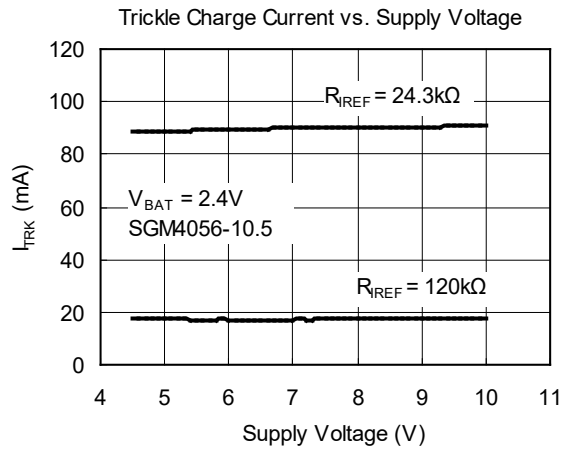
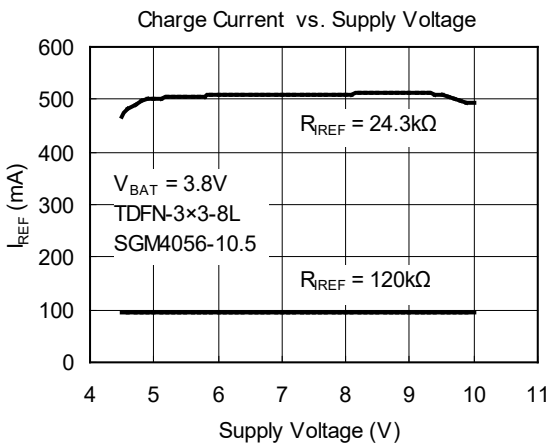
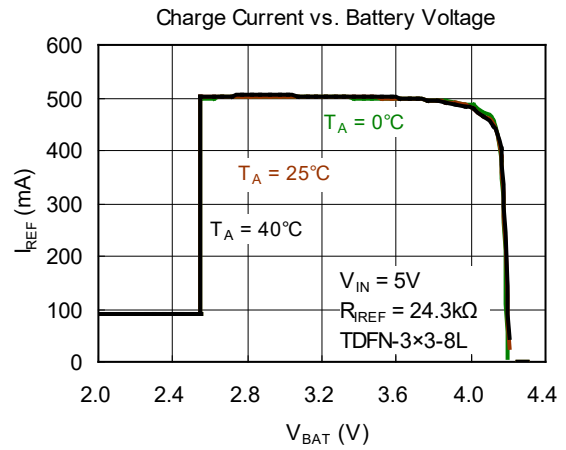
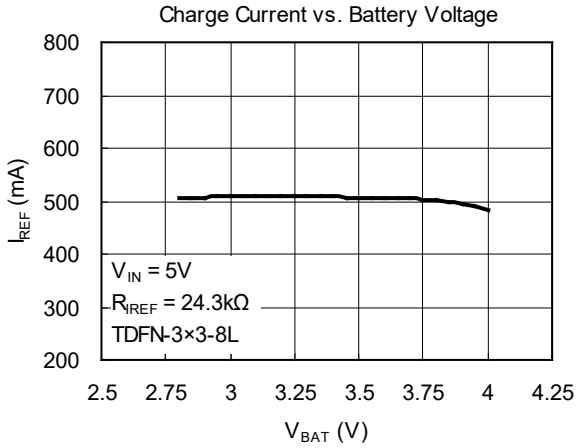

TYPICAL PERFORMANCE CHARACTERISTICS (continued)

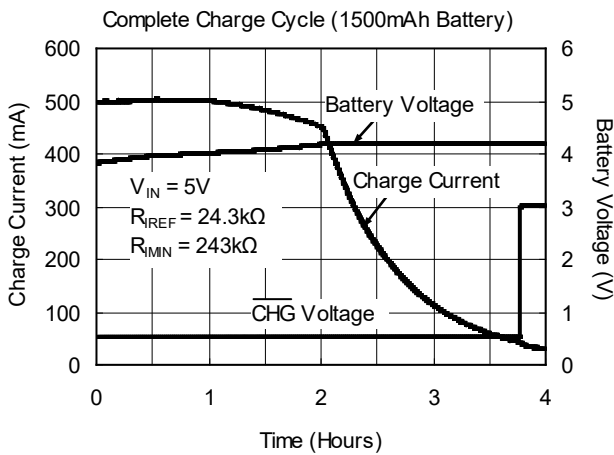
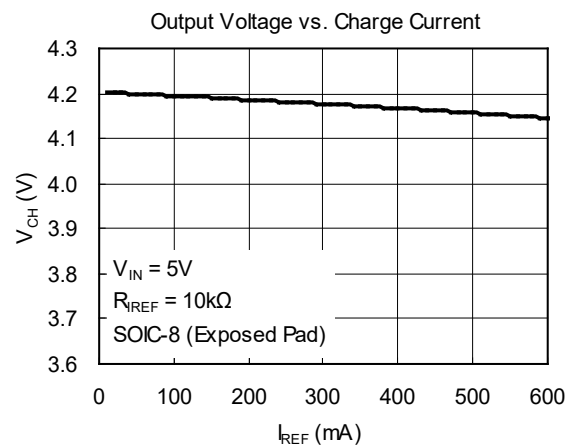
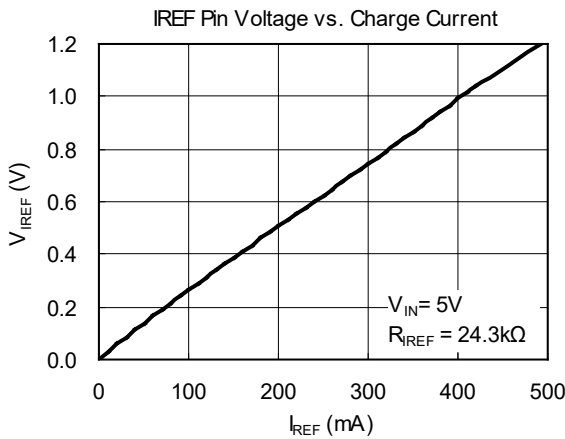
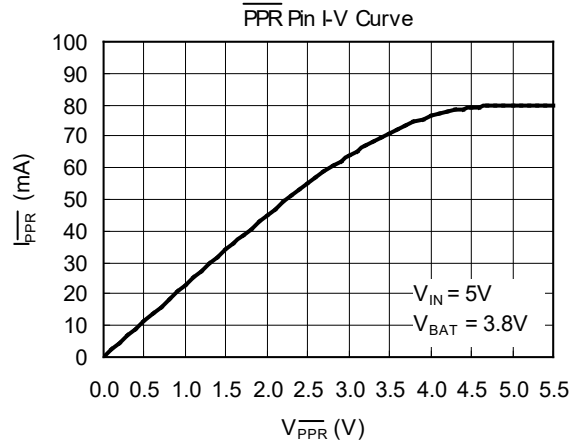
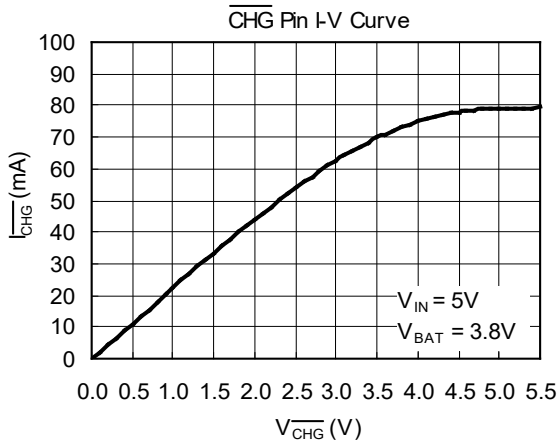

TYPICAL PERFORMANCE CHARACTERISTICS (continued)

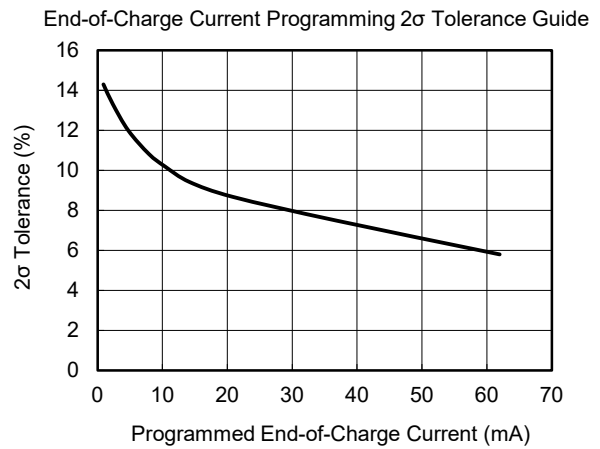
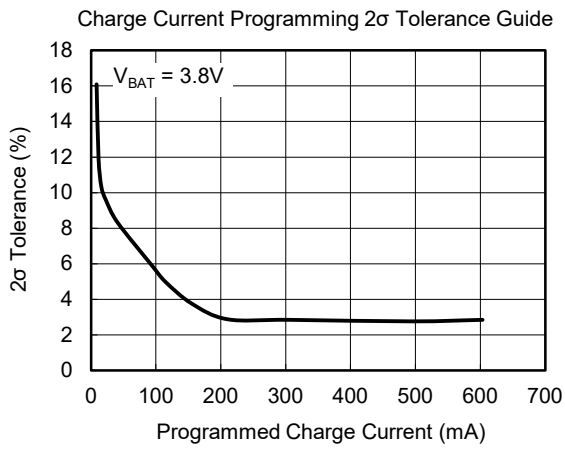

REVISION HISTORY

NOTE: Page numbers for previous revisions may differ from page numbers in the current version.

AUGUST 2018 – REV.A.4 to REV.B

Update Pin Description section.....	4
Update Typical Performance Characteristics section	11

OCTOBER 2017 – REV.A.3 to REV.A.4

Changed Electrical Characteristics section	5
--------------------------------------------------	---

MAY 2017 – REV.A.2 to REV.A.3

Changed Absolute Maximum Ratings section.....	2
-----------------------------------------------	---

MAY 2015 – REV.A.1 to REV.A.2

Changed Pin Description section.....	3
Added Typical Performance Characteristics section	10

NOVEMBER 2014 – REV.A to REV.A.1

Changed Electrical Characteristics section	4
--------------------------------------------------	---

Changes from Original (JANUARY 2013) to REV.A

Changed from product preview to production data.....	All
------------------------------------------------------	-----

PACKAGE OUTLINE DIMENSIONS

TDFN-3x3-8L

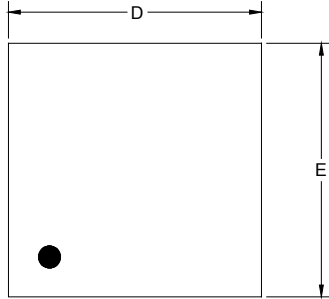

TOP VIEW

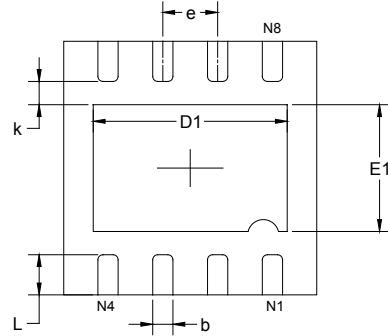

BOTTOM VIEW

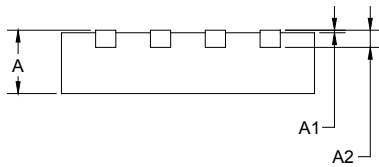

SIDE VIEW

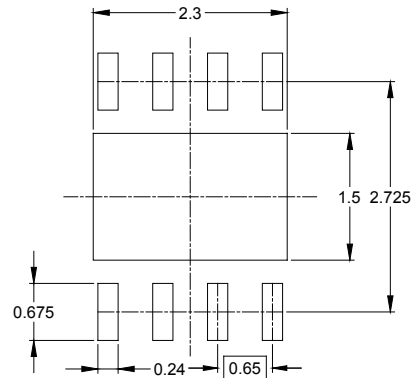

RECOMMENDED LAND PATTERN (Unit: mm)

Symbol	Dimensions In Millimeters		Dimensions In Inches	
	MIN	MAX	MIN	MAX
A	0.700	0.800	0.028	0.031
A1	0.000	0.050	0.000	0.002
A2	0.203 REF		0.008 REF	
D	2.900	3.100	0.114	0.122
D1	2.200	2.400	0.087	0.094
E	2.900	3.100	0.114	0.122
E1	1.400	1.600	0.055	0.063
k	0.200 MIN		0.008 MIN	
b	0.180	0.300	0.007	0.012
e	0.650 TYP		0.026 TYP	
L	0.375	0.575	0.015	0.023

PACKAGE OUTLINE DIMENSIONS

TDFN-2x3-8L

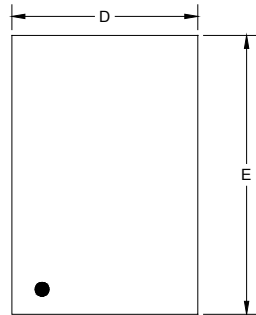

TOP VIEW

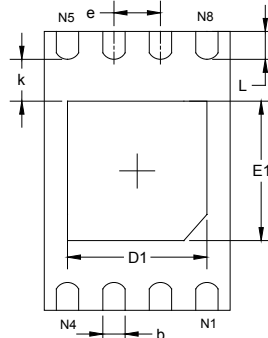

BOTTOM VIEW

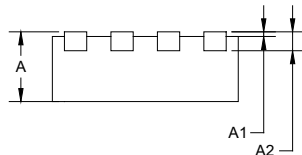

SIDE VIEW

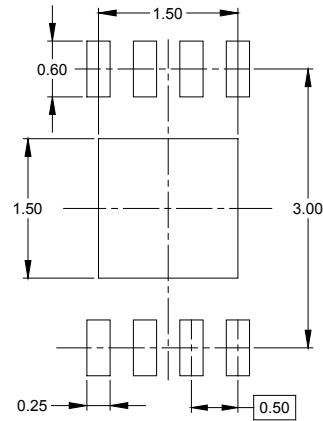

RECOMMENDED LAND PATTERN (Unit: mm)

Symbol	Dimensions In Millimeters		Dimensions In Inches	
	MIN	MAX	MIN	MAX
A	0.700	0.800	0.028	0.031
A1	0.000	0.050	0.000	0.002
A2	0.203 REF		0.008 REF	
D	1.924	2.076	0.076	0.082
D1	1.400	1.600	0.055	0.063
E	2.924	3.076	0.115	0.121
E1	1.400	1.600	0.055	0.063
k	0.200 MIN		0.008 MIN	
b	0.200	0.300	0.008	0.012
e	0.500 TYP		0.020 TYP	
L	0.224	0.376	0.009	0.015

PACKAGE OUTLINE DIMENSIONS

TDFN-2x2-8L

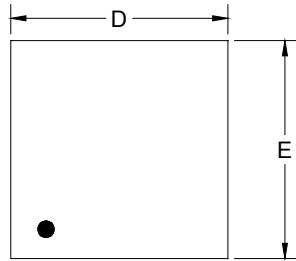

TOP VIEW

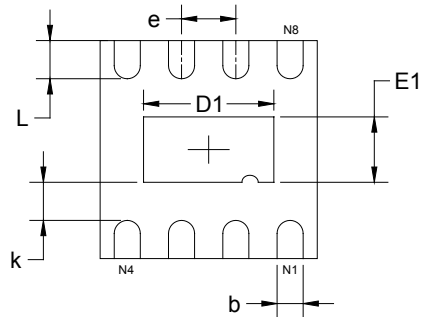

BOTTOM VIEW

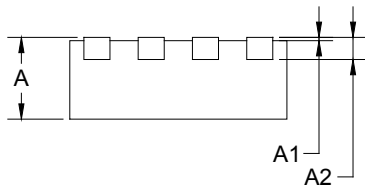

SIDE VIEW

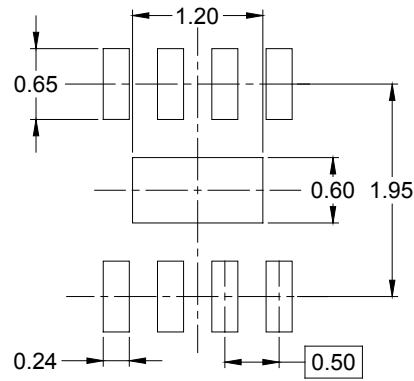

RECOMMENDED LAND PATTERN (Unit: mm)

Symbol	Dimensions In Millimeters		Dimensions In Inches	
	MIN	MAX	MIN	MAX
A	0.700	0.800	0.028	0.031
A1	0.000	0.050	0.000	0.002
A2	0.203 REF		0.008 REF	
D	1.900	2.100	0.075	0.083
D1	1.100	1.300	0.043	0.051
E	1.900	2.100	0.075	0.083
E1	0.500	0.700	0.020	0.028
k	0.200 MIN		0.008 MIN	
b	0.180	0.300	0.007	0.012
e	0.500 TYP		0.020 TYP	
L	0.250	0.450	0.010	0.018

PACKAGE OUTLINE DIMENSIONS

SOIC-8 (Exposed Pad)

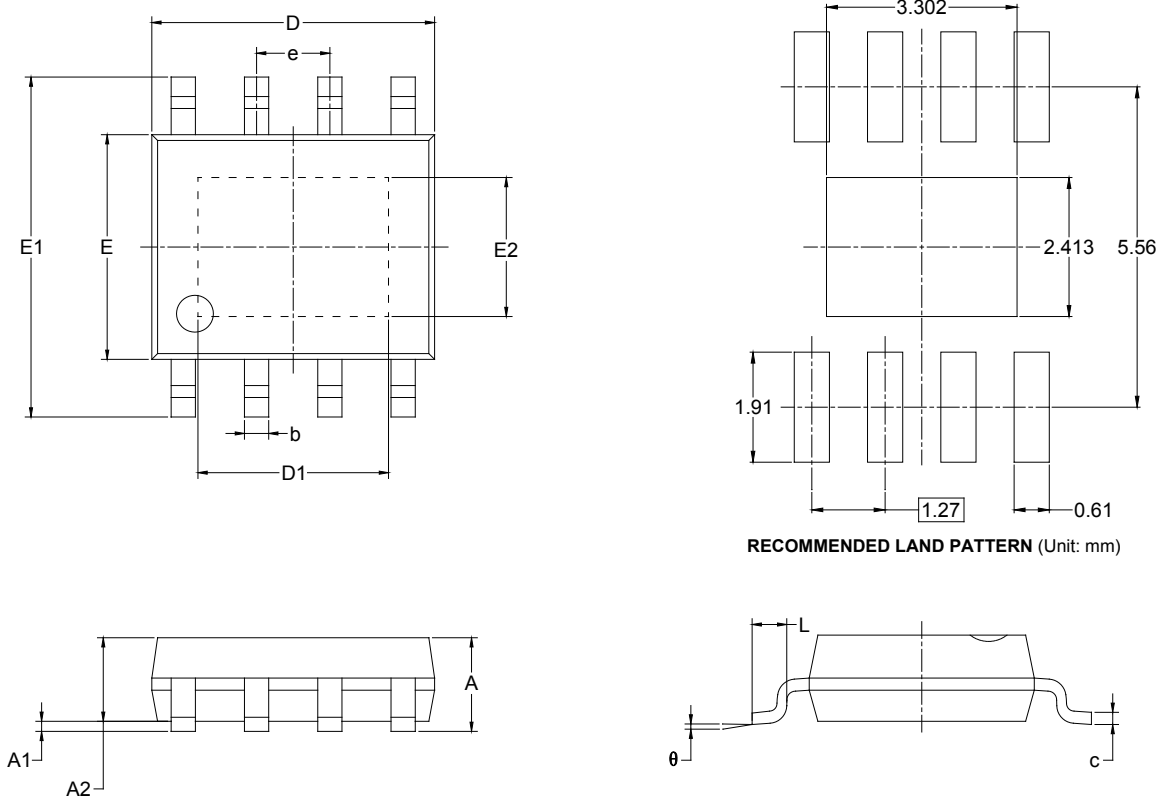

Symbol	Dimensions In Millimeters		Dimensions In Inches	
	MIN	MAX	MIN	MAX
A		1.700		0.067
A1	0.000	0.100	0.000	0.004
A2	1.350	1.550	0.053	0.061
b	0.330	0.510	0.013	0.020
c	0.170	0.250	0.007	0.010
D	4.700	5.100	0.185	0.201
D1	3.202	3.402	0.126	0.134
E	3.800	4.000	0.150	0.157
E1	5.800	6.200	0.228	0.244
E2	2.313	2.513	0.091	0.099
e	1.27 BSC		0.050 BSC	
L	0.400	1.270	0.016	0.050
θ	0°	8°	0°	8°

PACKAGE INFORMATION

TAPE AND REEL INFORMATION

REEL DIMENSIONS

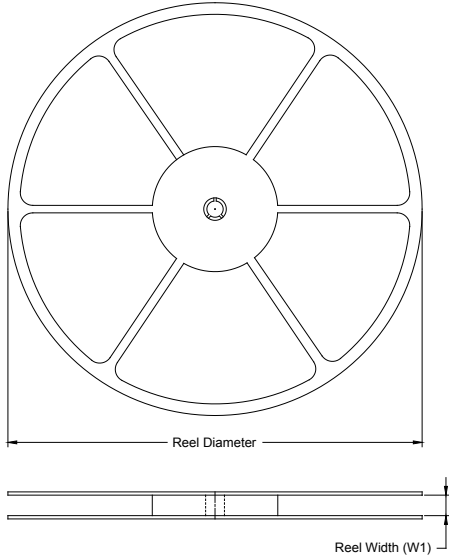

TAPE DIMENSIONS

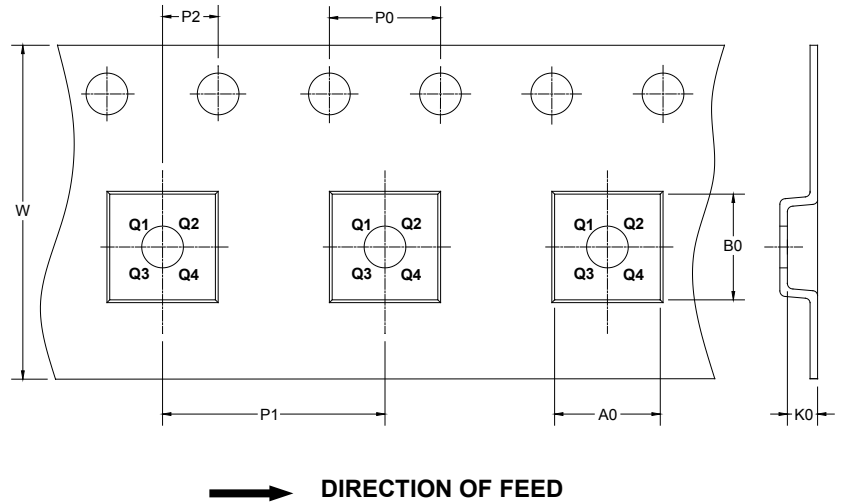

NOTE: The picture is only for reference. Please make the object as the standard.

KEY PARAMETER LIST OF TAPE AND REEL

Package Type	Reel Diameter	Reel Width W1 (mm)	A0 (mm)	B0 (mm)	K0 (mm)	P0 (mm)	P1 (mm)	P2 (mm)	W (mm)	Pin1 Quadrant
TDFN-3×3-8L	13"	12.4	3.35	3.35	1.13	4.0	8.0	2.0	12.0	Q1
TDFN-2×3-8L	7"	9.5	2.30	3.30	1.10	4.0	4.0	2.0	8.0	Q2
TDFN-2×2-8L	7"	9.5	2.30	2.30	1.10	4.0	4.0	2.0	8.0	Q1
SOIC-8 (Exposed Pad)	13"	12.4	6.40	5.40	2.10	4.0	8.0	2.0	12.0	Q1

DD0001

PACKAGE INFORMATION

CARTON BOX DIMENSIONS



NOTE: The picture is only for reference. Please make the object as the standard.

KEY PARAMETER LIST OF CARTON BOX

Reel Type	Length (mm)	Width (mm)	Height (mm)	Pizza/Carton
7" (Option)	368	227	224	8
7"	442	410	224	18
13"	386	280	370	5

DD0002