

## OSC32254P-27.000MHZ

### Features

- Low power supply voltage (1.8V)
- LVPECL output level.
- Supports a WIDE FREQUENCY RANGE (32.768kHz to 100 MHz)
- Low phase jitter: Max, 1ps
- Compact with dimensions of 3.2\*2.5\*1.2mm.

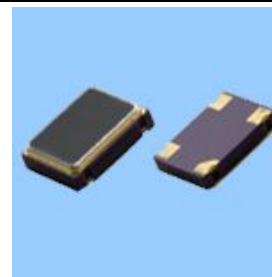

### Specifications

项目 Item	技术 Specifications
频率范围 Freq. Range	27.000MHZ
频率稳定性 Frequency Stability	$\pm 10\text{PPm}$ , $\pm 20\text{PPm}$ , $\pm 30\text{PPm}$ , $\pm 50\text{PPm}$
工作温度 Operating Temp	$-10^{\circ}\text{C}$ to $60^{\circ}\text{C}$ $-20^{\circ}\text{C}$ to $70^{\circ}\text{C}$ $-40^{\circ}\text{C}$ to $85^{\circ}\text{C}$
储存温度 Storage Temp	$-40^{\circ}\text{C}$ to $85^{\circ}\text{C}$ $-55^{\circ}\text{C}$ to $125^{\circ}\text{C}$
输入电压 Input	+5Vdc $\pm 10\%$ or +3.3Vdc $\pm 5\%$ +1.8Vdc $\pm 3\%$
占空比 Symmetry	40/60 Standard
输出 Output Load	10 TTL or 15PF HCMOS
消耗电流	Current Consumption 15pf only) (5.0V)
	1.000MHZ - 36.000MHZ = 25mA max
	36.000MHZ - 70.000MHZ = 60mA max
	70.000MHZ - 150.000MHZ = 80mA max
Current Consumption 15pf only) (1.8V, 2.5V, 2.85V, 3.3V)	1.000MHZ - 36.000MHZ = 20mA max
	36.000MHZ - 70.000MHZ = 40mA max
	70.000MHZ - 150.000MHZ = 60mA max
上升/下降时间 Rise/Fall Time	10nS max

### Dimensions

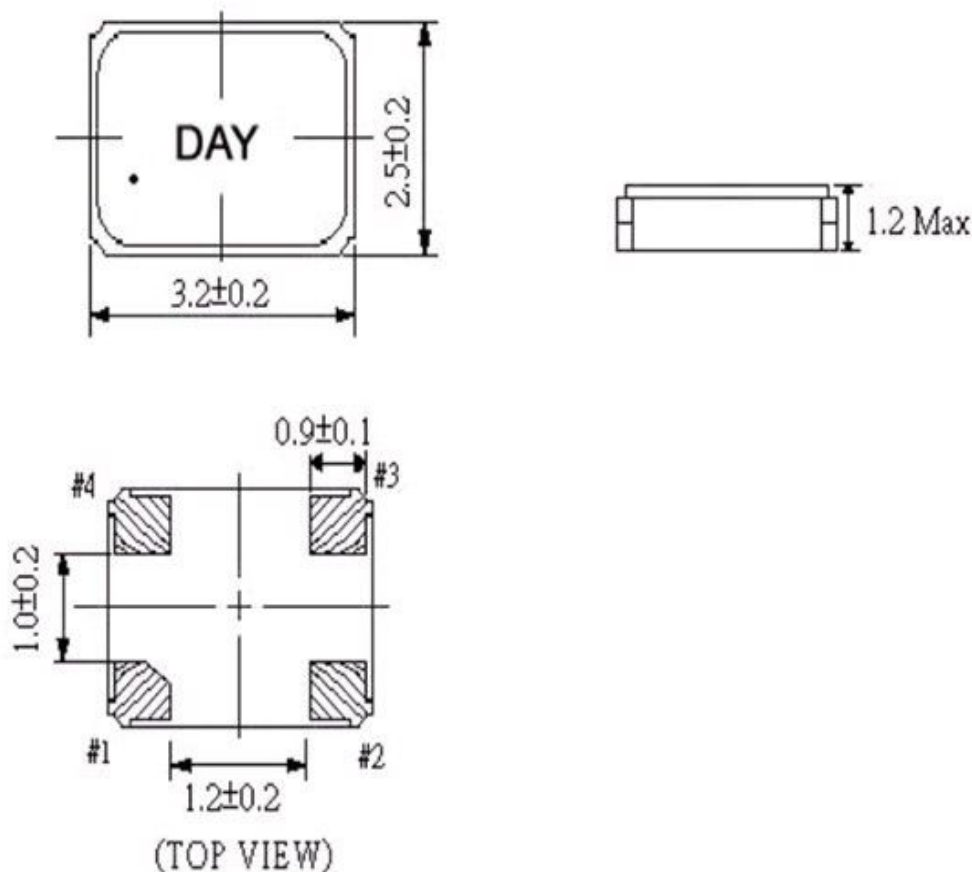

## Ordering Information

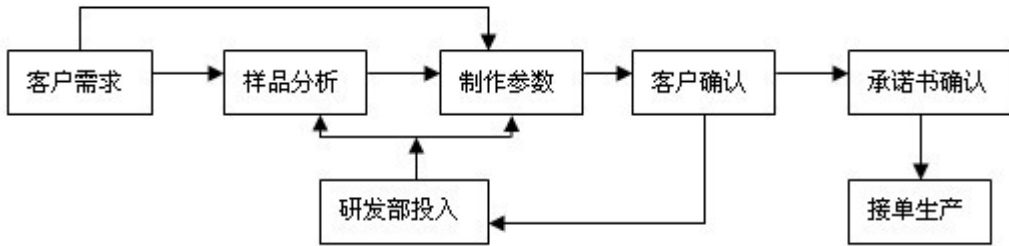

## 使用电路图和引出端功能说明

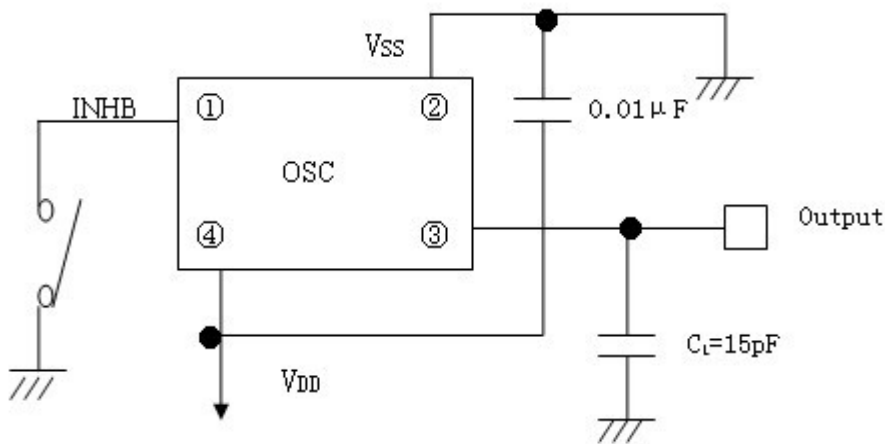

引脚	1	2	3	4
功能	输出状态控制/NC	地VSS	输出QOUT	电源VDD

输出控制端INHB	"H" 高电平或开路OPEN	"L" 低电平 (三态)
输出Qout	振荡器正常输出	高阻抗

注意：输出状态控制端INHB（三态端）不能接地，否则振荡器呈高阻抗

## 测试电路图

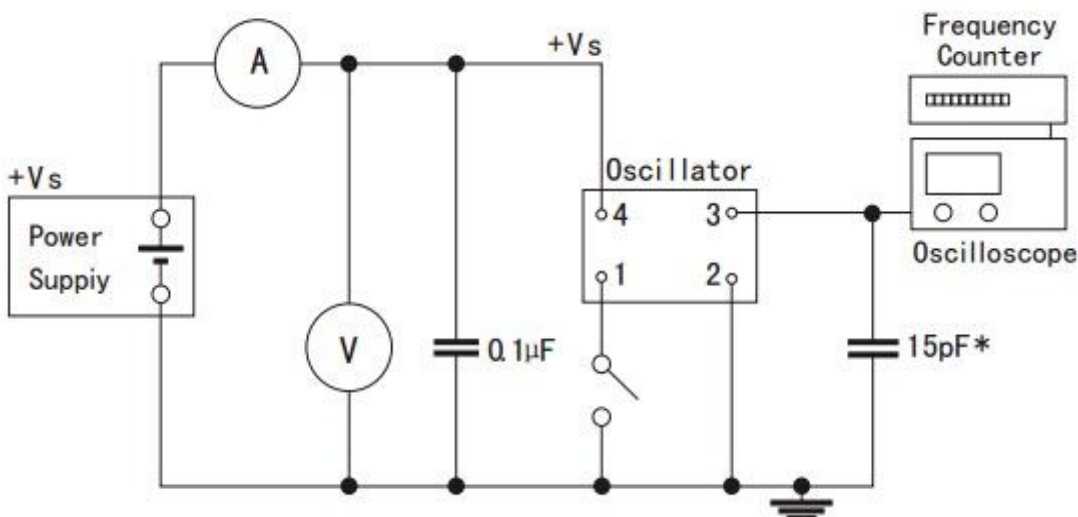

## ■ Reflow Condition

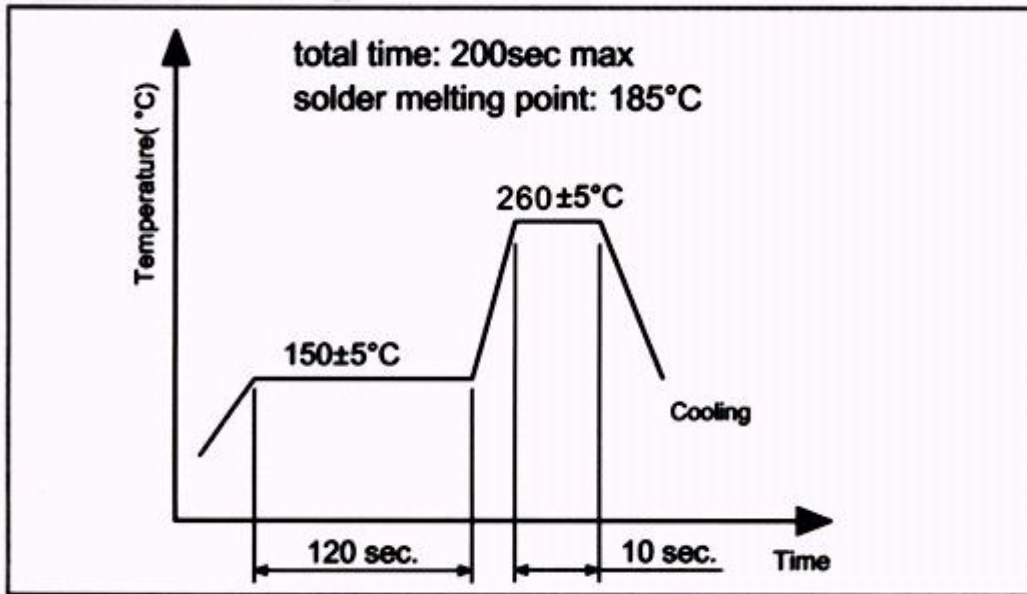

## ■ 输出波形图

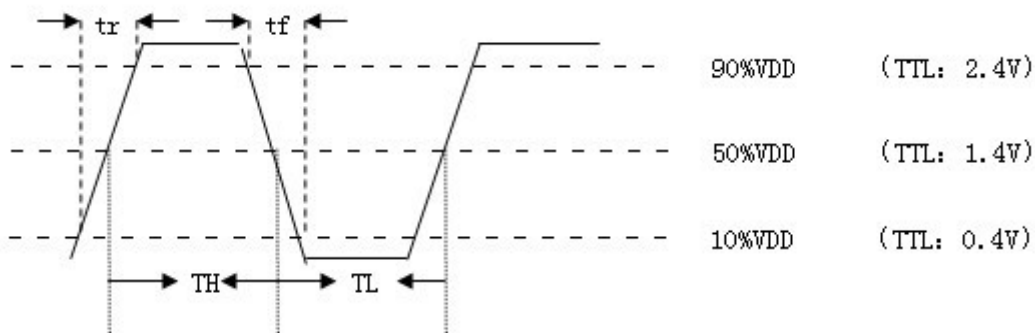

■ 编带尺寸图TAPE:

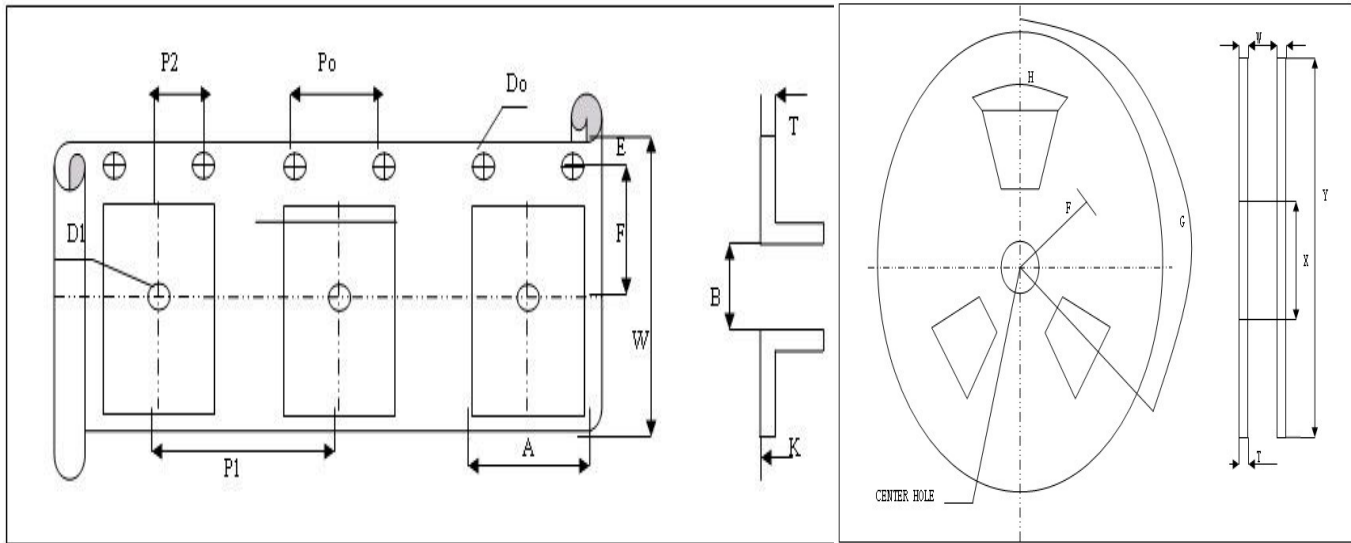

Symbol		A	B	Do	D1	E	
DIMENSION	7*5	5.5	7.5	1.5	1.5	1.75	
Symbol		K	Po	P1	P2	T	
DIMENSION	7*5	1.9	4	8	2	0.3	Unit :mm
Symbol		H	F	G	W	T	Y
Dimension	7*5	40°	21 ± 0.8	120	17.5	2	250