

OSC3225-66.000MHZ

■ Features

- Tight frequency tolerance.
- CMOS compatible logic levels.
- Pin-compatible with standard 3.2*2.5*1.2mm. packages
- Low power standby mode.
- Designed for standard reflow and washing techniques.
- Available on tape & reel, 1000pcs per reel.
- Pb-free and RoHS/Green compliant.

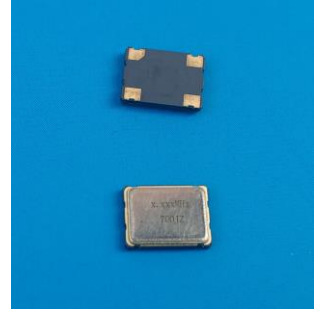

■ APPLICATIONS

- Ideally suited designed for use in Ethernet, network adapter cards, hard disk devices, blue tooth PCMCIA Cards, Palmtop Computer, Portable Applications.

■ Specifications 电气参数

项目 Item	技术 Specifications
频率范围 Freq. Range	66.000MHZ
总频差 Frequency Stability	$\pm 20\text{ppm TO } \pm 50\text{ppm}$
工作温度 Operating Temp	$-10^{\circ}\text{C to } 60^{\circ}\text{C} / -40^{\circ}\text{C to } 85^{\circ}\text{C}$
储存温度 Storage Temp	$-40^{\circ}\text{C to } 85^{\circ}\text{C} / -55^{\circ}\text{C to } 125^{\circ}\text{C}$
输入电压 Supply Voltage	+5Vdc or 3.3V $\pm 10\%$ ※(see Notes)
占空比 Symmetry	40/60 Standard
输出 Output Load	10 TTL or 15PF HCMOS
消耗电流	Current Consumption 15pf only) (5.0V)
	1.000mhz-49.999mhz =25mA max
	50.000mhz-125.000mhz =80mA max
	Current Consumption 15pf only) (1.8V 2.5V 2.85V 3.3V)
1.000mhz-49.999mhz =20mA max	
50.000mhz-125.000mhz =60mA max	
上升/下降时间 Rise/Fall Time	5nS max

※Notes: The supply voltage 1.8V, 2.5V, 2.85V also can be made by customer.

■ Test Circuit 测试电路图

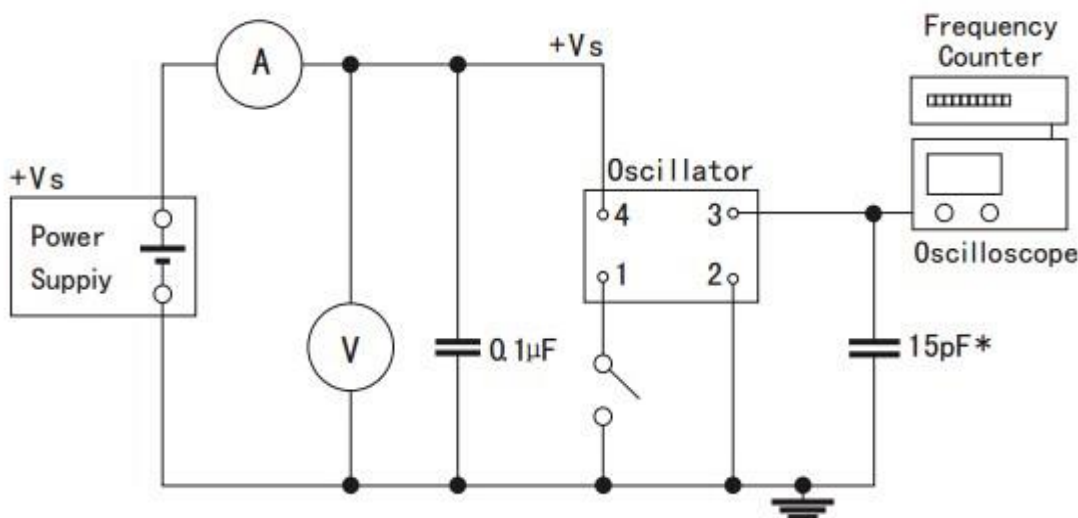

Tri-state: PIN 1 connected to Vdd or floating, the product is working properly; connected to GND, stops working



Dimensions 尺寸封装图

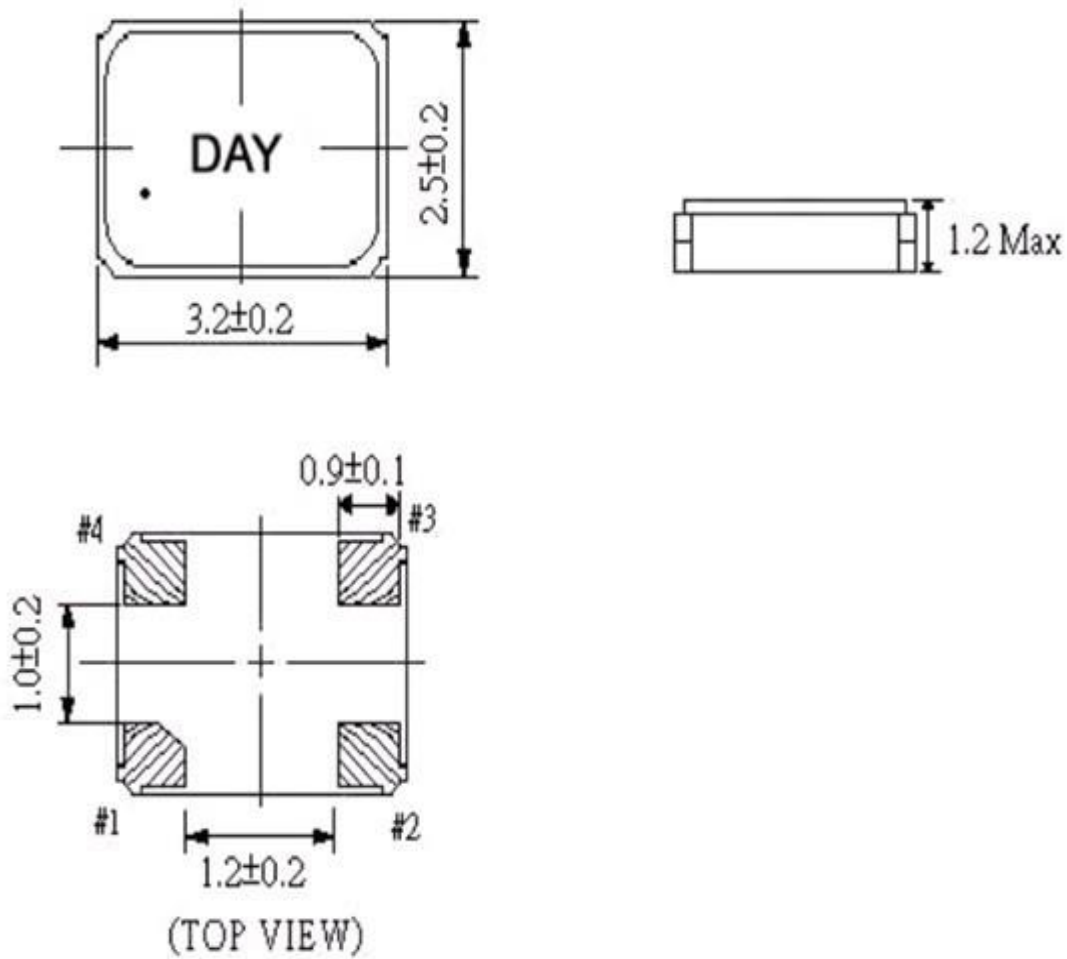

输出波形图

