

壓敏電阻器產品承認書

APPROVAL SPECIFICATIONS FOR METAL OXIDE VARISTORS

客戶 CUSTOMER			
客戶料號 CUSTOMER P/N			
產品編碼 PART NUMBER	07D561K-IT		
規格描述 DESCRIPTION	07D561K/F5.08/L24/ZNR/T		
日期 DATE	2022-07-05	文件編號 DOC. NO.	DEC-WD-WI001(C)

德爾創承認欄 APPROVED BY DERSONIC			客戶承認欄 APPROVED BY CUSTOMER	
批准 APPROVED BY	審核 CHECK BY	制訂 FORMULATE BY	批准 APPROVED BY	審核 CHECK BY
彭少雄	吳成愛 承認專用章	陳冬花		

東莞市德爾創電子有限公司

DONGGUAN CITY DERSONIC ELECTRONICS CO., LTD.

廣東省東莞市長安鎮錦廈河南工業區錦平路 5 號

NO.5, JINGPING ROAD, JINXIA HENAN INDUSTRIAL ZONE, CHANGAN TOWN DONGGUAN CITY, PRC

TEL: 86-769-8155 5686

FAX: 86-0769-8155 5989

WEBSITE: [HTTP://WWW.DERSONIC.COM](http://www.dersonic.com)

E-MAIL: SALES@DERSONIC.COM

目录 CONTENTS	数据表 DATA SHEET	2
	特点 FEATURES	3
	安规认证 SAFETY APPROVAL	3
	标志 MARKING	3
	特性 GENERAL CHARACTERISTICS	4
	用途 APPLICATIONS	6
	适用范围 APPLICATIONS SCOPE	6
	测量与试验 MEASUREMENT AND TESTING	7
	包装 PACKAGING	10
	编带规格 TAPING SPECIFICATIONS	11
	安全注意事项 SAFETY PRECAUTIONS	12



請確保我們的產品安裝到您的產品上前，已根據您的需求進行了評估。

Please make sure that your product has been evaluated in view of your specifications with our product being mounted to your product.

請您在使用我們的產品時，不要偏離此標準。

You are requested not to use our product deviating from this specification.

数据表
DATA SHEET

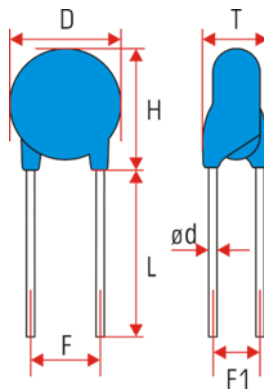



产品编码 Part number		07D561K-IT
规格描述 Description		07D561K/F5.08/L24/ZNR/T
客户料号 Customer P/N		
最大連續工作電壓 Max continuous operating voltage		AC350V (max) DC460V (max)
壓敏電壓, V_N Varistor voltage, V_N		560V \pm 10% @ 1mA 30ms
標稱脈衝電流, I_p Nominal pulse current, I_p		10A @ 8/20 μ s
最大抑制電壓, V_C Maximum clamping voltage, V_C		915V (max) @ I_p
耐衝擊電流 Withstanding surge current	最大脈衝電流 Maximum pulse current	1250A (1 time) @ 8/20 μ s 600A (2 times) @ 8/20 μ s (5 minute interval)
	重複脈衝電流 Repetitive pulse current	450A (10 times), @ 8/20 μ s (90 sec. interval)
	衝擊壽命 Impulse life	75A (10 000 times) @ 8/20 μ s (10 sec. interval)
最大耐受能量 Maximum energy		35J @ 10/1000 μ s
額定功率 Rated power		0.25W
最大漏電流 Maximum leakage current		20 μ A @ 75% V_N
最大電容量 Maximum capacitance		90pF @ 1kHz 1.0Vrms
工作溫度範圍 Operating temperature range		-40 $^{\circ}$ C ~ +125 $^{\circ}$ C
尺寸 DIMENSIONS	D (Diameter)	9.5mm max
	T (Thickness)	4.1mm \pm 0.8mm
	H (Height)	12.5mm max
	F (Lead spacing)	5.08mm \pm 1.0mm
	F1 (Lead malposed spacing)	2.88mm \pm 0.5mm
	L (Lead length)	24mm \pm 4.0mm
	ϕd (Lead diameter)	0.58mm \pm 0.10mm

压敏电阻器 METAL OXIDE VARISTORS

特点 FEATURES

- 标称直径
Nominal diameter: 5mm, 7mm, 10mm, 14mm, 20mm, 25mm etc.
- 工作电压范围
Wide operating voltage range up to 1000Vac (1500Vdc)
- 工作温度范围
Operating temperature range: -40°C ~ +85°C (Hi-temperature up to 125°C)
- 10D、14D、20D符合IEC 60950-1附录Q需求
10D, 14D, 20D meet IEC 60950-1, Annex Q requirement
- 采用UL94 V-0级环氧树脂包封
Coated with flame-retardant epoxy resin conforming to UL94 V-0 standard
- 小型紧凑，耐电涌电流量大
Very large surge withstanding capability with a compact size
- 能响应瞬时浪涌的卓越灵敏度
Fast response to steep impulse voltage
- 抑制电压低，保护效果可靠
Low clamping voltage for better surge protection
- 无续流
No follow-on current
- 可适用于自动化生产线
Cost-saving automatic insertion available
- 已应对RoHS指令，无卤
RoHS compliant, halogen-free

安规认证 SAFETY APPROVAL

认证机构 Certificate authority	认证标准 Approval standard	证书编号 Certificate No.	认证范围 Certification range
	UL 1449	E485399	07D180K~07D821K 10D180K~10D112K 14D180K~14D182K 20D180K~20D182K
	IEC 61051-1 (ed.2) IEC 61051-2 (ed.1); am1 IEC 61051-2-2 (ed.1)	B 096835 0001	
	GB/T 10193-1997 GB/T 10194-1997 GB4943.1-2011 (10D, 14D, 20D) GB8898-2011 (10D, 14D, 20D)	CQC14001104814 CQC16001149384 CQC16001149385 CQC16001149386	

Remark: additional test for 10D, 14D, 20D series: Annex Q of IEC 60950-1:2005 / A2:2013, clause 14.13 of IEC 60065:2014 and clause G.8.1 of IEC 62368-1:2018.

标志 MARKING

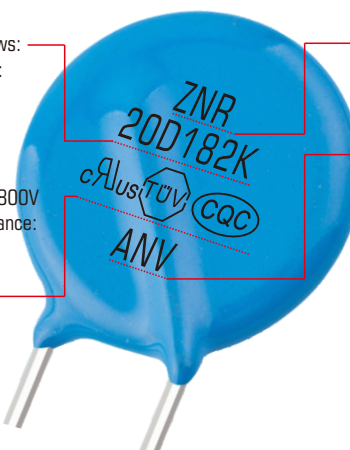

压敏电阻器标志在本体上用激光雕刻而成，其内容如下图所示。
As shown in figure, the marking of varistor is laser engraving on the body.



Varistor specs, explain as follows:

- 20: Nominal diameter, ex.: 20=20mm
- D: Shape, ex.: D is disc
- 182: Varistor voltage, ex.: 182=18×10²V=1800V
- K: Varistor voltage tolerance: K: ±10%

Recognized approval mark

- UL/cUL: 
- TÜV SÜD: 
- CQC: 

Dersonic trademark

- ⊕W
- ZNR
- ZNRC

Internal identification code

A N V

Production ID

- K: General type
- D: Standard type
- T: Hi-temperature (125°C) type
- V: Hi-energy type
- J: Withstanding surge type (ex.: 07D, 2.5KV/1.25KA, 40 times; 10D, 4KV/2KA, 40 times; 14D, 6KV/3KA, 40 times; 20D, 10KV/5KA, 40 times)
- Q: Appendix Q (IEC 60950-1) type

Production year

- A: 2020;
- B: 2021
- ⋮
- Z: 2045;
- A: 2046

Production month

- 1: Jan; 2: Feb
- ⋮
- 9: Sept; 0: Oct
- N: Nov; D: Dec

特性 GENERAL CHARACTERISTICS

型号 Model	工作电压 Operating voltage		限制电压 Clamping voltage Vc @ Ip 8/20μs	压敏电压 Varistor voltage (@ 1mA)
	AC	DC		
	V max.	V max.	V max.	V
180K	11	14	36	15.8 ~ 20.7
220K	14	18	43	19.4 ~ 25.3
270K	17	22	53	23.7 ~ 31.1
330K	20	26	65	29.0 ~ 36.3
390K	25	31	77	35.1 ~ 42.9
470K	30	38	93	42.3 ~ 51.7
560K	35	45	110	50.4 ~ 61.6
680K	40	56	135	61.2 ~ 74.8
820K	50	65	135	73.8 ~ 90.2
101K	60	85	165	90 ~ 110
121K	75	100	200	108 ~ 132
151K	95	125	250	135 ~ 165
181K	115	150	300	162 ~ 198
201K	130	170	340	180 ~ 220
221K	140	180	360	198 ~ 242
241K	150	200	395	216 ~ 264
271K	175	225	455	243 ~ 297
301K	195	250	505	270 ~ 330
331K	210	275	545	297 ~ 363
361K	230	300	595	324 ~ 396
391K	250	320	650	351 ~ 429
431K	275	350	710	387 ~ 473
471K	300	385	775	423 ~ 517
511K	320	415	845	459 ~ 561
561K	350	460	915	504 ~ 616
621K	385	505	1025	558 ~ 682
681K	420	560	1120	612 ~ 748
751K	460	615	1240	675 ~ 825
781K	485	640	1290	702 ~ 858
821K	510	670	1355	738 ~ 902
911K	550	745	1500	819 ~ 1001
102K	625	825	1650	900 ~ 1100
112K	680	895	1815	990 ~ 1210
122K	750	1060	2000	1080 ~ 1320
142K	880	1140	2310	1260 ~ 1540
162K	940	1280	2640	1440 ~ 1760
182K	1000	1465	2970	1620 ~ 1980

尺寸规格 Size spec	等级电流 Class current Ip @ 8/20μs	耐冲击电流 Withstanding impulse current					额定功率 Rated power
		8/20μs			10/100μs	2ms	
		1 time	10 times	10 ⁴ times	1 time	1 time	
	A	A	A	A	A	A	W

Varistor voltage: 180K ~ 680K (D, T type)

05D	1.0	125	25	4	2	1	0.01
07D	2.5	250	62.5	10	5	2.5	0.02
10D	5.0	500	125	20	10	5	0.05
14D	10.0	1k	250	40	20	10	0.10
20D	20.0	2k	500	80	40	20	0.20

Varistor voltage: 180K ~ 680K (V type)

05D	1.0	250	62.5	10	5	2.5	0.01
07D	2.5	500	125	20	10	5	0.02
10D	5.0	1k	250	40	20	10	0.05
14D	10.0	2k	500	60	40	20	0.10
20D	20.0	3k	750	120	60	30	0.20

Varistor voltage: 820K ~ 182K (D, T, K type)

05D	5.0	600	180	17	13.5	6.8	0.1
07D	10.0	1.25k	450	75	25	12.5	0.25
10D	25.0	2.5k	750	120	50	25	0.4
14D	50.0	4.5k	1.5k	150	100	50	0.6
20D	100.0	6.5k	2.3k	190	200	100	1.0

Varistor: 820K ~ 182K (V, J, Q type)

05D	5.0	800	250	22	18	9	0.1
07D	10.0	1.75k	600	100	36	18	0.25
10D	25.0	3.5k	1k	150	72	36	0.4
14D	50.0	6.0k	2k	200	145	72	0.6
20D	100.0	10k	3k	250	290	148	1.0
25D	150.0	20k	6.5k	275	440	220	1.1
32D	200.0	25k	10k	450	720	360	1.2
34S	300.0	40k	15k	750	1100	550	1.4

Note:

K type: General type (Voltage gradient: 260 V/mm)

D type: Standard type (Voltage gradient: 240 V/mm)

T type: Hi-temperature (125°C) type, based on D type

V type: Hi-energy type

J type: Withstanding surge type

Nominal dia.	Withstanding surge type (1.2/50μs - 8/20μs combination wave)
07D	2.5KV/1.25KA, 40 times, 60 sec interval
10D	4KV/2KA, 40 times, 60 sec interval
14D	6KV/3KA, 40 times, 60 sec interval
20D	10KV/5KA, 40 times, 60 sec interval

Four phases (0°, 90°, 180°, 270°), the positive and negative poles of each phase are 5 times each, a total of 40 times

Q type: Appendix Q (IEC 60950-1, 6KV/3KA)

特性 GENERAL CHARACTERISTICS

■ 温度降额曲线
Temperature derating curves

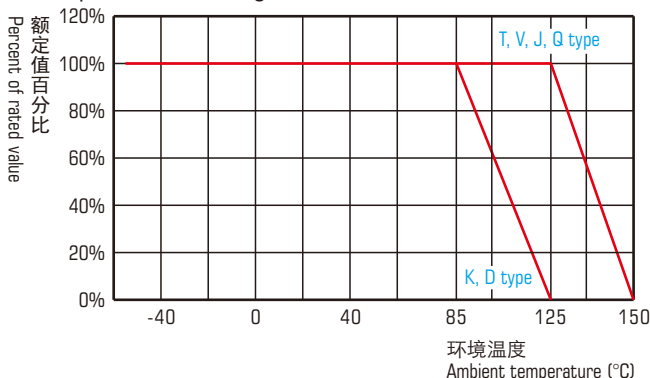

K和D型85°C到125°C降额系数为2.5%/°C
K and D type: 85°C to 125°C derating factor: 2.5% per °C

额定值请参考“安全注意事项”2.2项说明。
Please refer to item 2.2 of “SAFETY PRECAUTIONS”
for the rating value.

■ 脉冲电流与脉冲时间降额曲线
Pulse current versus pulse time derating curves

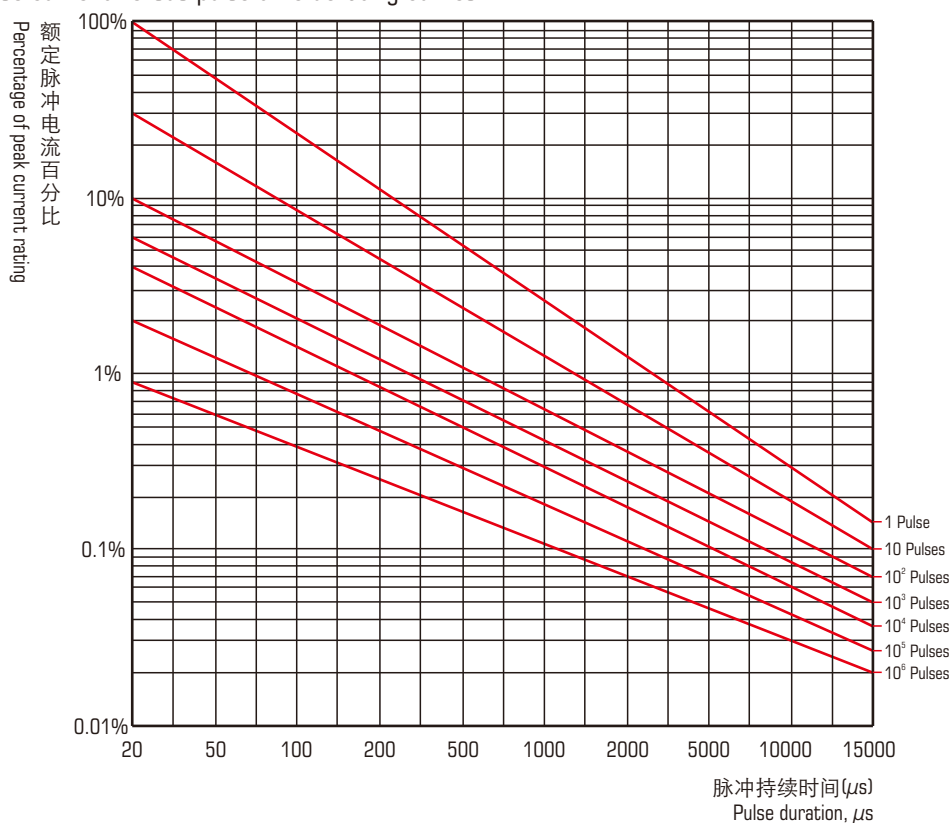

用途 APPLICATIONS

- 消费电子产品：电视机、音频输出设备、安全插座、机顶盒等
Consumer electronics products: television, audio output device, Safety plug, STB etc.
- 工业产品：马达、半导体元件、继电器、电磁开关、电源线路、三相整流线路、自动控制线路等
Industrial products: motor, semiconductor component, relay, electromagnetic switch, power circuit, Three-phase rectifier circuit, automatic control circuit etc.
- 通信设备：电话机、传真机、交换机等
Communication equipment: Telephone, facsimile, exchanger etc.
- 计算机：计算机、显示器、打印机、扫描仪、电源、电源适配器等
Computer: computer, displayer, printer, scanner, power supply, adapter etc.
- 汽车电子产品
Automotive electronics products

适用范围 APPLICATIONS SCOPE

规格 Model	规格 Model	规格 Model	规格 Model	规格 Model	规格 Model	主要用途 Recommended Applications
05D180K 05D220K 05D270K 05D330K 05D390K 05D470K 05D560K 05D680K	07D180K 07D220K 07D270K 07D330K 07D390K 07D470K 07D560K 07D680K	10D180K 10D220K 10D270K 10D330K 10D390K 10D470K 10D560K 10D680K	14D180K 14D220K 14D270K 14D330K 14D390K 14D470K 14D560K 14D680K	20D180K 20D220K 20D270K 20D330K 20D390K 20D470K 20D560K 20D680K	25D180K 25D220K 25D270K 25D330K 25D390K 25D470K 25D560K 25D680K	用于低压电路，如用于保护半导体器件、汽车电子产品、DC48V以下的继电器与电磁阀、静电放电设备、行动电话等 For the low voltage circuit, Such as for the protection of emiconductor devices, automotive electronics, DC48V following relays and solenoid valves, electrostatic discharge equipment, mobile phones, etc.
05D820K 05D101K 05D121K 05D151K	07D820K 07D101K 07D121K 07D151K	10D820K 10D101K 10D121K 10D151K	14D820K 14D101K 14D121K 14D151K	20D820K 20D101K 20D121K 20D151K	25D820K 25D101K 25D121K 25D151K	用于电话，DC48V通信电路电线 Telephone, communication line (DC48V)
05D181K 05D201K 05D221K	07D181K 07D201K 07D221K	10D181K 10D201K 10D221K	14D181K 14D201K 14D221K	20D181K 20D201K 20D221K	25D181K 25D201K 25D221K	用于AC100V线与线间(如日本) AC100V line-line applications (Japan etc.)
05D241K 05D271K 05D301K	07D241K 07D271K 07D301K	10D241K 10D271K 10D301K	14D241K 14D271K 14D301K	20D241K 20D271K 20D301K	25D241K 25D271K 25D301K	用于AC100~120V线与线间(如日本、美国等) AC100V~120V, line-line applications (Japan, US etc.)
05D331K 05D361K 05D391K	07D331K 07D361K 07D391K	10D331K 10D361K 10D391K	14D331K 14D361K 14D391K	20D331K 20D361K 20D391K	25D331K 25D361K 25D391K	用于AC100~120V线与线间，用于电话(应对250V绝缘阻抗测试) AC100V~120V, line-line applications, telephone line applications (for DC250V insulation resistance test)
05D431K 05D471K 05D511K	07D431K 07D471K 07D511K	10D431K 10D471K 10D511K	14D431K 14D471K 14D511K	20D431K 20D471K 20D511K	25D431K 25D471K 25D511K	用于AC200~220V线与线间、线与大地间 AC200V~220V, line-line and line-ground applications
05D531K 05D561K 05D621K 05D681K	07D531K 07D561K 07D621K 07D681K	10D531K 10D561K 10D621K 10D681K	14D531K 14D561K 14D621K 14D681K	20D531K 20D561K 20D621K 20D681K	25D531K 25D561K 25D621K 25D681K	用于AC240V线与线间、线与大地间(如英国、澳洲等) AC240V, line-line and line-ground applications (UK, Australia etc.)
05D751K	07D751K 07D781K 07D821K	10D751K 10D781K 10D821K	14D751K 14D781K 14D821K	20D751K 20D781K 20D821K	25D751K 25D781K 25D821K	用于AC380V线与线间、线与大地间 AC380V, line-line and line-ground applications
	07D911K	10D911K	14D911K	20D911K	25D911K	用于AC415V线与线间、线与大地间 AC415V, line-line and line-ground applications
		10D102K 10D112K 10D122K	14D102K 14D112K 14D122K	20D102K 20D112K 20D122K	25D102K 25D112K 25D122K	用于AC480V线与线间、线与大地间 AC480V, line-line and line-ground applications
		10D182K	14D182K	20D182K	25D182K	用于线与大地间(应对AC1200V耐压测试) line-ground applications (for AC1200V withstanding test)

测量与试验 MEASUREMENT AND TESTING

如无特殊需要，压敏电阻器应在下列环境条件下进行试验：

If there is no special need, varistors measurement and testing should be conducted under the following environmental conditions:

温度 Temperature	相对湿度 Relative humidity	大气压力 Atmospheric pressure
25°C±5°C	30%~70%	86kPa~106kPa

序号 NO.	检验项目 ITEM	试验方法 TESTING METHOD	要求 SPECIFICATION
1	外观与尺寸 Appearance and dimension	外观形状没有明显的缺点，尺寸在标准范围内。 No marked defect on appearance form and dimensions are within specified range.	压敏电阻必须用目视检查其明显的缺点。 The varistors should be visually inspected for evidence of defect. 尺寸用游标卡尺测量。 Dimensions should be measured with slide calipers.
2	标志 Marking	清晰易于识别。 To be easily legible.	目视检查。 The capacitor should be visually inspected.
3	抑制电压 Clamping voltage	满足额定值 To meet the specified value.	使用波形为8/20μs的标称脉冲电流施加在压敏电阻引出端上，同时测试抑制电压的峰值。 A nominal pulse current of 8/20μs waveform was applied to the varistor terminals and the clamping voltage peak was tested.
4	压敏电压 Varistor voltage (V _N)	在误差范围内。 Within specified tolerance.	将压敏电阻固定在不锈蚀的夹具上，按产品参数表规定的条件进行测试压敏电阻器引出端的电压。 The varistor is fixed on the fixture without rust, and the voltage of the varistor terminal is tested according to the conditions specified in the data sheet.
5	电容量 Capacitance	满足额定值 To meet the specified value.	在标准大气条件下，使用1kHz、1V的条件进行测量。 Measurement at 1kHz, 1V under standard atmospheric conditions.
6	漏电流 Leakage current	满足额定值 To meet the specified value.	在25°C时施加75%的最大连续直流电压，测量其漏电流。 Apply a maximum continuous dc voltage of 75% to the varistor at 25°C and measure its leakage current.
7	电流冲击稳定性 Impulse testing stability	重复脉冲电流 Repritive pulse current	试验过程中压敏电阻应无击穿、闪络，外观不应有任何机械损伤 The varistor should have no breakdown or flashover during the test, and the appearance should not have any mechanical damage
		方波电流 Square wave current	冲击后，应在常温下恢复2h，测量压敏电压，其值相对于初始值的变化率应小于10% After the impulse, it should be stored at room temperature for 2hrs. measure the varistor voltage. The rate of change should be less than 10% of the initial value.
8	最大脉冲电流 Max pulse current	在8/20μs波形下，对压敏电阻施加10次重复脉冲电流，每个方向冲击各5次，相邻两次冲击的间隔为90s。 Under 8/20μs waveform, the varistor was subjected to 10 times of repritive pulse current, and the impulses was 5 times in each direction. the interval between two adjacent impulses was 90 s.	对压敏电阻施加1次方波电流冲击(2ms或者10/1000μs)的冲击，方向任意。 The varistor is subjected to a square wave current impulse (2ms or 10/1000μs), in any direction.
9	耐电压 Withstand voltage	试验过程中压敏电阻无击穿、电弧、闪络等现象，外观不应有任何机械损伤 The varistor should have no breakdown, arcing or flashover during the test, and the appearance should not have any mechanical damage	首先，将压敏电阻端子拧在一起，然后如右图所示，将金属箔包住压敏电阻离端子3-4mm的本体，接着将压敏电阻插入盛着直径为1mm的金属球的容器中，最后施加2500V的电压60秒钟。 First, the terminals of the varistor should be connected together. Then, as shown in figure at right, a metal foil should be closely wrapped around the body of the varistor to the distance of about 3 to 4mm from each terminal. Then, the varistor should be inserted into a container filled with metal balls of about 1mm diameter. Finally, 2500V voltage is applied for 60s between the varisor lead wires and metal balls.
10	冲击寿命 Impulse life	试验后压敏电阻外观不应有任何机械损伤，压敏电压变化率不应超过10% After the test, the appearance of the varistor should not have any mechanical damage, and the varistor voltage change rate should not exceed 10%	常室温下，将指定的脉冲电流间隔10秒接通10000次，在2小时时间段内测定其特性。 The change of varistor voltage shall be measured after the specified impulse current is applied 10000 times continuously with the interval of 10s at room temperature.

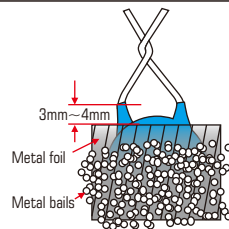

测量与试验

MEASUREMENT AND TESTING

序号 NO.	检验项目 ITEM	试验方法 TESTING METHOD	要求 SPECIFICATION
11	最大能量 Maximum energy	满足额定值 To meet the specified value.	在10/1000μs电流波下，压敏电阻能承受的最大能量。 The maximum energy that the varistor can absorb under the 10/1000μs current wave.
12	额定功率 Rated power	满足额定值 To meet the specified value.	在环境温度25°C下施加连续脉冲电流时，压敏电阻可以耗散的最大平均功率。 Maximum allowable average power dissipation when subjected to the stress of successive impulses and at the temperature of 25°C.
13	压敏电压温度系数 Temperature coefficient of varistor voltage	满足额定值 To meet the specified value.	$\frac{V_{N2} - V_{N1}}{V_{N1}} \times 1/60 \times 100\% \text{ (%/}^\circ\text{C)}$ 式中， V_{N1} 是25°C下的压敏电压值， V_{N2} 是85°C下的压敏电压值 Where V_{N1} is varistor voltage at 25°C and V_{N2} is varistor voltage at 85°C
14	导线抗张强度 Terminal tensile strength	导线无折断，压敏电阻无破损。 Lead wire should not be cut off. Varistor should not be broken.	固定压敏电阻的本身，使压敏电阻器每支导线均承受10N(1.0mm导线直径为20N)垂直力，保持10±1秒钟。 Fix the body of the varistor and apply a tensile weight gradually to each lead wire in the radial direction of the capacitor up to 10N (1.0mm lead wire diameter is 20N) and keep it for 10±1s.
15	导线抗折强度 Terminal bending strength	导线无折断，压敏电阻无破损。 Lead wire should not be cut off. Varistor should not be broken.	压敏电阻导线应承受5N(1.0mm导线直径为10N)重量，然后向外弯折成90°，然后回复到原来位置；接着往反方向弯折90°，再复原；弯折一次2-3秒钟。 Each lead wire should be subjected to 5N (1.0mm lead wire diameter is 10N) weight and then a 90° bend, at the point of egress, in one direction, return to original position, and then apply a 90° bend in the opposite direction at the rate of one bend in 2 to 3s.
16	可焊性 Solderability of leads	导线必须有3/4以上的面积均匀附着焊锡。 Lead wire should be soldered with uniform coating on the axial direction over 3/4 of the circumferential direction.	将压敏电阻器的导线浸入焊料中2±0.5秒钟，浸入深度离导线根部1.5-2.0mm。 The lead wire of a varistor should be dipped into molten solder for 2±0.5s. the depth of immersion is up to about 1.5 to 2.0mm from the root of lead wires. 焊锡温度： 无铅焊锡(Sn-3Ag-0.5Cu) 245±5°C 易溶解的H63号锡(Pb37/Sn63) 235±5°C Temp. of solder: lead free solder (Sn-3Ag-0.5Cu) 245±5°C H63 eutectic solder (Pb37/Sn63) 235±5°C
17	耐焊接热 Soldering effect	试验后压敏电阻外观不应有任何机械损伤，压敏电压变化率不应超过5% After the test, the appearance of the varistor should not have any mechanical damage, and the varistor voltage change rate should not exceed 5%	如图所示，导线浸入离导线根部1.5-2.0mm处、锡温为260±5°C锡槽中10±1秒。 As shown in figure, the lead wires should be immersed in solder of 260±5°C up to 1.5 to 2.0mm from the root of terminal for 10±1.0s. 试验后，压敏电阻应在室温中恢复2小时。 After the test, the varistor should recover at room temperature for 2hrs. 
18	振动 Vibration resistance	试验后压敏电阻外观不应有任何机械损伤，压敏电压变化率不应超过5% After the test, the appearance of the varistor should not have any mechanical damage, and the varistor voltage change rate should not exceed 5%	将压敏电阻导线焊稳和调整振动频率范围为10-55Hz、总振幅为1.5mm，振动从10Hz到55Hz，然后再回到10Hz，大约一分钟。 The varistor should be firmly soldered to the supporting lead wire and vibrated at a frequency range of 10Hz to 55Hz, 1.5mm in total amplitude, with about a 1 minute rate of vibration change from 10Hz to 55Hz and back to 10Hz. 总时间六个小时，每两小时在相互垂直方向来回三次。 Apply for a total of 6hrs, 2hrs each in 3 mutually perpendicular directions.
19	耐湿负荷 Humidity loading	试验后压敏电阻外观不应有任何机械损伤，压敏电压变化率不应超过10% After the test, the appearance of the varistor should not have any mechanical damage, and the varistor voltage change rate should not exceed 10%	压敏电阻保持在温度为40±2°C、相对湿度为90-95%条件下施加最大连续交流电压500±12小时。 Apply the max continuous operating ac voltage for 500±12hrs at 40±2°C in 90% to 95% relative humidity. 试验结束后，压敏电阻器应在室温下恢复2小时。 After the test, the varistor should recover at room temperature for 2hrs.

测量与试验 MEASUREMENT AND TESTING

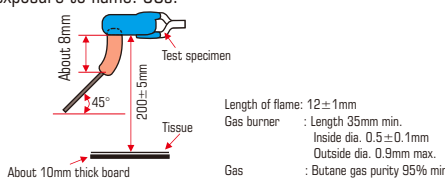
序号 NO.	检验项目 ITEM	试验方法 TESTING METHOD	要求 SPECIFICATION															
20	高温负荷 High temperature loading	试验后压敏电阻外观不应有任何机械损伤，压敏电压变化率不应超过10% After the test, the appearance of the varistor should not have any mechanical damage, and the varistor voltage change rate should not exceed 10%	应给压敏电阻施加最大连续交流电压，储存最高工作温度下 1000 ± 12 小时。 The maximum continuous ac voltage should be applied to the varistor and stored at a maximum operating temperature of 1000 ± 12 hrs. 试验结束后，压敏电阻器应在室温下恢复2小时。 After the test, the varistor should recover at room temperature for 2hrs.															
21	温度循环 Temperature cycle	试验后压敏电阻外观不应有任何机械损伤，压敏电压变化率不应超过10% After the test, the appearance of the varistor should not have any mechanical damage, and the varistor voltage change rate should not exceed 10%	进行如下循环5次，之后放置在室温中2小时，目测外观有无异常，并测定其特性。 The temperature cycle shown below shall be repeated five cycles and then stored at room temperature for 2hrs. the change of varistor voltage and mechanical damage shall be examined. <table border="1" style="margin-left: auto; margin-right: auto;"> <thead> <tr> <th>步骤 Step</th> <th>1</th> <th>2</th> <th>3</th> <th>4</th> </tr> </thead> <tbody> <tr> <td>温度(°C) Temperature (°C)</td> <td>-55 ± 3</td> <td>5~35</td> <td>125 ± 2</td> <td>5~35</td> </tr> <tr> <td>时间(分钟) Period (minutes)</td> <td>30 ± 3</td> <td>15 ± 3</td> <td>30 ± 3</td> <td>15 ± 3</td> </tr> </tbody> </table>	步骤 Step	1	2	3	4	温度(°C) Temperature (°C)	-55 ± 3	5~35	125 ± 2	5~35	时间(分钟) Period (minutes)	30 ± 3	15 ± 3	30 ± 3	15 ± 3
步骤 Step	1	2	3	4														
温度(°C) Temperature (°C)	-55 ± 3	5~35	125 ± 2	5~35														
时间(分钟) Period (minutes)	30 ± 3	15 ± 3	30 ± 3	15 ± 3														
22	阻燃性 Passive flammability	燃烧时间不超过30秒，棉纸不被点燃。 The burning time should not exceed 30s, the tissue paper should not ignite.	压敏电阻在下面试验中，火焰在适当的位置被最大燃烧，各个试验样品应只承受一次燃烧，燃烧时间30秒钟。 The varistor under test should be held in the flame in the position which best promotes burning. Each specimen should only be exposed once to the flame. Time of exposure to flame: 30s. 															

■ 试验电流波形图 Testing current waveform

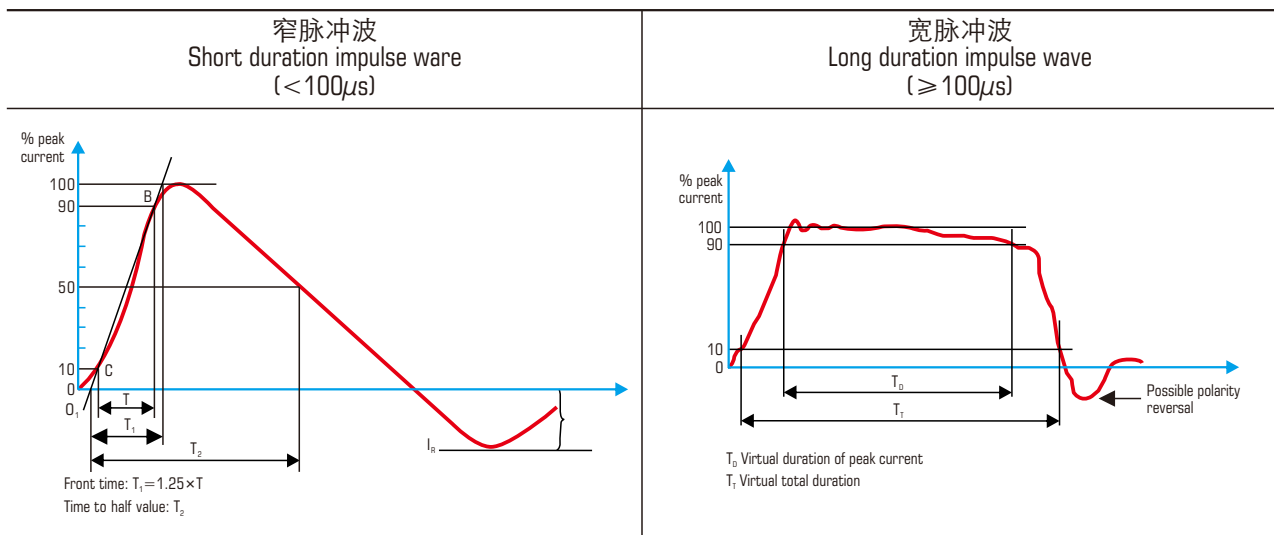

包装 PACKAGING

■ 散件包装

Bulk packing

散件包装最小包装为PE袋，其包装数量如下表所示；一定数量的最小包装装入内盒中，最后4个小盒或10个小盒，装入大箱中，具体由产品规格确定。

The minimum packing of bulk packaging is PE bag, the packing quantity is shown in the following table; a certain number of minimum packaging into the inner box, the last 4 inner boxes or 10 inner boxes, loaded into the outer box, specifically determined by the product specifications.

标称直径 Nominal diameter	5mm	7mm	10mm	14mm	20mm	25mm
最小包装数量 Minimum packaging quantity	1000pcs	1000pcs	500pcs	500pcs	250pcs	200pcs

■ 编带包装

Taping packing

编带尺寸规格见下一页，其包装盒或卷盘尺寸，及最小包装数量如下表所示

The taping specifications are shown on the next page, the dimensions of the ammo or reel, and minimum packaging quantity are shown in the following table

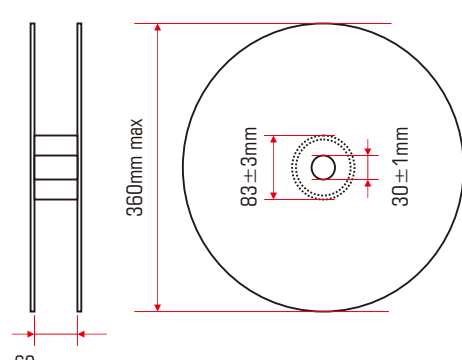
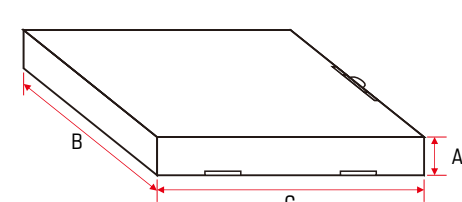
包装方式 Packaging format	卷盘包装 Reel packaging	折叠包装 Ammo packaging												
尺寸与图示 Dimensions and drawing		 <table border="1" data-bbox="925 1232 1420 1344"> <thead> <tr> <th>Nominal diameter</th> <th>A</th> <th>B</th> <th>C</th> </tr> </thead> <tbody> <tr> <td>5mm, 7mm, 10mm</td> <td>43±2mm</td> <td>256±5mm</td> <td>335±5mm</td> </tr> <tr> <td>14mm, 20mm</td> <td>48±2mm</td> <td>288±5mm</td> <td>335±5mm</td> </tr> </tbody> </table>	Nominal diameter	A	B	C	5mm, 7mm, 10mm	43±2mm	256±5mm	335±5mm	14mm, 20mm	48±2mm	288±5mm	335±5mm
Nominal diameter	A	B	C											
5mm, 7mm, 10mm	43±2mm	256±5mm	335±5mm											
14mm, 20mm	48±2mm	288±5mm	335±5mm											

卷盘包装一盘装四盒，每盒二盘；折叠包装一盒装十盒。

Reel packaging 4 boxes per carton, 2 reels per boxed; Ammo packaging 10 boxes per carton.

最小包装数量如下表所示：

Minimum packaging quantity is shown in the table below:

标称直径 Nominal diameter	压敏电阻 Varistor voltage	卷盘包装(每卷) Reel packing(per reel)	折叠包装(每盒) Ammo packing(per box)
5mm	180K~431K	1 500 pcs	1 500 pcs
	471K~751K	1 000 pcs	1 000 pcs
7mm	180K~431K	1 500 pcs	1 500 pcs
	471K~821K	1 000 pcs	1 000 pcs
10mm	180K~431K	1 000 pcs	1 000 pcs
	471K~182K	750 pcs	750 pcs
14mm	180K~431K	1 000 pcs	1 000 pcs
	471K~182K	750 pcs	750 pcs
20mm	180K~431K	500 pcs	500 pcs
	471K~182K	250 pcs	250 pcs

备注：最小包装数量可能会根据生产实际情况发生变化。

Note: The minimum packing quantity may vary depending on the actual production.

安全注意事项

SAFETY PRECAUTIONS

使用压敏电阻器时，压敏电阻器周围条件（设备设计中的材料、环境、电源条件、电路条件等）发生异常时，则可能引发火灾、触电、烧伤、以及产品故障。

In case that a varistor is used, if an abnormality takes place because of peripheral conditions of the varistor (material, environments, power source conditions, circuit conditions, etc. In equipment design), fire, electric shock, burn, or product failure may be occur.

下列内容为使用时的相关注意事项，请认真确认后再生使用。如对未及事项有疑议，请速与我公司担当部门联系。
The precautions for this product are described below; understand the content thoroughly before usage. For more questions, contact us.

1. 严格遵守事项

Precautions to be strictly observed

1.1. 额定性能确认

Confirmation of performance ratings

请遵守压敏电阻器的最大连续工作电压，耐冲击电流、最大能量、浪涌寿命、额定功率和操作温度范围等额定性能的规定，在规定范围内使用。

Use the varistor within its rated range of performance such as the maximum continuous operating voltage, withstanding surge current, maximum energy, impulse life, rated power and operating temperature range.

超出规定范围使用，则会造成压敏电阻器性能劣化，破坏元件，严重可引起压敏电阻器冒烟或起火。

If used outside the range, the varistor can be degrade and have element fracture, which may result in smoking and ignition.

1.2. 为避免意外现象发生，请采用如下对策

To avoid accidents due to unexpected phenomena, take the following measures

1) 压敏电阻器受损时，可能出现破碎飞散，因此要对集成产品加保护盖或外盒。

In the event of fracture of the varistor, its pieces may scatter; hence, put the case or cover of the set product in place.

2) 请勿安装在可燃物品（塑料电线、树脂合成物等）附近。若无法避免，请使用不燃性保护外壳。

Do not install the varistor near combustible substances (polyvinyl chloride wires, resin moldings, etc.). If it's difficult to do, install a nonflammable cover.

3) 线间使用

Across-the-line use

在线间使用时，将保险丝与压敏电阻器串联。

When the varistor is used across a line, put a current fuse in series with the varistor.

4) 线-地间使用

Use between line to ground

a) 在线-地间使用时，压敏电阻器短路时会产生接地电阻，电流保险丝不会熔断，可能引起压敏电阻器外涂层树脂冒烟或起火。

If the case that the varistor is used between a line to the ground, the short circuit of the varistor may not blow the current fuse because of grounding resistance, which may cause smoking and ignition of the varistors exterior resin.

为避免上述情况，请在电源端安装漏电断路器。如无漏电断路器，则需将保险丝与温度保险丝串联使用。

As the measure against it, install an earth leakage breaker on the power supply side of the varistor position. If no earth leakage breaker is installed, use a thermal fuse together with a current fuse in series.

b) 在带电部件与金属部件之间使用压敏电阻器时，压敏电阻器短路时有触电危险，故请将金属部件接地或勿与人体接触。

If the case that the varistor is used between a live parts to metal case, an electric shock may develop at a shortcircuit of the varistor; hence, ground the metal case to the ground or keep it from the human body.

2. 使用注意事项

Application notes

注意下列事项，可能导致压敏电阻器寿命缩短或引发故障

Pay attention to the following items to avoid the shortened life and failure of the varistor.

2.1. 电路条件

Circuit conditions

1) 选定的压敏电阻器的电压最大值在最大连续工作电压值之上。

Select a varistor of which the maximum voltage including fluctuations in source voltage allows for the maximum permissible circuit voltage.

2) 短间隔性地施加浪涌时（施加抗干扰模拟试验电压时），不可超过压敏电阻器的额定功率。

In cases that surges are intermittently applied at short intervals (for example, in case that the voltage of the noise simulator test is implemented etc.), do not let them exceed the varistor rated power.

安全注意事项 SAFETY PRECAUTIONS

3) 选定压敏电阻器时，须按照表1的标准产品型号
Select a varistor recommended in table 1.

a) 线间使用

Across-the-line use

单相三线式连线时单独配线负荷导致负荷不平衡、电压线和中性线短路、中性线欠损、容量性负荷情况下开闭时的共振等，将导致电源电压的上升，可能使用表1中标有*的产品型号。

If possible, use a varistor marked with * in case of voltage temporarily rises load unbalance of separately-wired loads, short between hot and neutral-line, open of neutral line in single-phase-three-wired system, and due to resonance at switching for a capacitive, inductive load.

b) 线-地间使用

Used between line to ground

出现故障时，对地电压将上升，因此，请使用附表1中推荐的产品型号。

Use a different varistor from "across-the-line use" as table 1, because of raising voltage in case of line to ground fault.

进行设备的绝缘电阻试验（DC500V）时，请使用表1中推荐的标有**的产品型号。使用不可清除绝缘性能试验的压敏电阻电压时，在一定的电路条件下，试验时可将压敏电阻器从电路上取下。

Use a varistor marked with ** in table 1, in case of the insulation resistance test (500VDC) for equipment. When using a part of the varistor voltage that the insulation efficiency examination can not be cleared, there is a case where the varistor can be done by removing it from the circuit depending on the circuit condition.

进行设备的耐电压试验（AC1000V或AC1200V）时，请使用表1中推荐的标有***的产品型号。

Use a varistor marked with *** in table 1, in case of the withstanding voltage test (1000VAC or 1200VAC) for equipment.

表1 – 压敏电阻器的适用范例
Table 1 - Example of varistor application

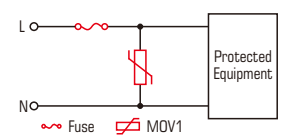
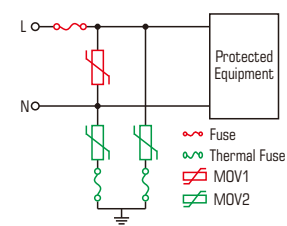
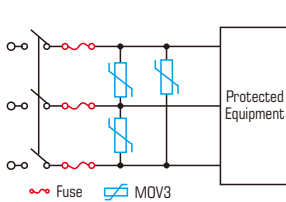
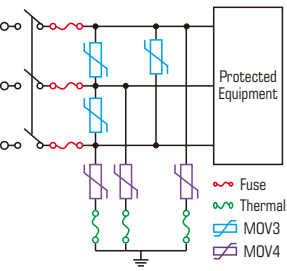
类别 Type	线间使用 Across-the-line use	线-地使用 Use between line to ground																																	
DC / AC单相 DC/AC single-phase																																			
连线举例 Connections example																																			
压敏电阻选型举例 Example of varistor	<table border="1"> <thead> <tr> <th>MOV</th> <th>电源电压 Source voltage</th> <th>压敏电阻 Varistor</th> </tr> </thead> <tbody> <tr> <td rowspan="6">MOV1 MOV3</td> <td>AC100V</td> <td>201~361*</td> </tr> <tr> <td>AC120V</td> <td>241~431*</td> </tr> <tr> <td>AC200V</td> <td>471~621*</td> </tr> <tr> <td>AC220V</td> <td>471~621*</td> </tr> <tr> <td>AC240V</td> <td>511~621*</td> </tr> <tr> <td>AC380V</td> <td>681~821*</td> </tr> <tr> <td></td> <td>DC12V</td> <td>220, 270</td> </tr> <tr> <td></td> <td>DC24V</td> <td>330~470</td> </tr> </tbody> </table>	MOV	电源电压 Source voltage	压敏电阻 Varistor	MOV1 MOV3	AC100V	201~361*	AC120V	241~431*	AC200V	471~621*	AC220V	471~621*	AC240V	511~621*	AC380V	681~821*		DC12V	220, 270		DC24V	330~470	<table border="1"> <thead> <tr> <th>MOV</th> <th>电源电压 Source voltage</th> <th>压敏电阻 Varistor</th> </tr> </thead> <tbody> <tr> <td rowspan="2">MOV2 MOV4</td> <td>AC100V ~ AC220V</td> <td>431, 471, 511 561, 621*, 681* 821**, 911** 182***</td> </tr> <tr> <td>AC230V AC240V</td> <td>471, 511, 561 561, 621*, 681* 821**, 911** 182***</td> </tr> <tr> <td></td> <td>AC380V</td> <td>112**, 122** 182***</td> </tr> </tbody> </table>	MOV	电源电压 Source voltage	压敏电阻 Varistor	MOV2 MOV4	AC100V ~ AC220V	431, 471, 511 561, 621*, 681* 821**, 911** 182***	AC230V AC240V	471, 511, 561 561, 621*, 681* 821**, 911** 182***		AC380V	112**, 122** 182***
MOV	电源电压 Source voltage	压敏电阻 Varistor																																	
MOV1 MOV3	AC100V	201~361*																																	
	AC120V	241~431*																																	
	AC200V	471~621*																																	
	AC220V	471~621*																																	
	AC240V	511~621*																																	
	AC380V	681~821*																																	
	DC12V	220, 270																																	
	DC24V	330~470																																	
MOV	电源电压 Source voltage	压敏电阻 Varistor																																	
MOV2 MOV4	AC100V ~ AC220V	431, 471, 511 561, 621*, 681* 821**, 911** 182***																																	
	AC230V AC240V	471, 511, 561 561, 621*, 681* 821**, 911** 182***																																	
	AC380V	112**, 122** 182***																																	

安全注意事项 SAFETY PRECAUTIONS

4) 关于电流保险丝

Concerning current fuse

a) 所用压敏电阻器与电流保险丝的额定电流，一般推荐按下表进行选定。此外，在用户端，当压敏电阻器损坏时，确认其设备是否会发生2次伤害。

We recommend selecting a varistor and the rated current of a current fuse as follows. Finally, please be sure that there is no danger if the varistor mounted on the equipment breaks.

标称直径 NOMINAL DIAMETER	5mm	7mm	10mm	14mm	20mm	25mm
保险丝额定电压 FUSE RATED CURRENT	2A max	5A max	7A max	10A max	10A max	15A max

b) 保险丝的插入部位建议按表1操作。但被保护设备的负荷电流较大、超过上述推荐保险丝额定电流时，保险丝请按下图连接。

The recommended fuse position is shown in table 1. however, if the load current of protected equipment is large than that of the above recommended fuse rated current, install a current fuse at the position shown below.

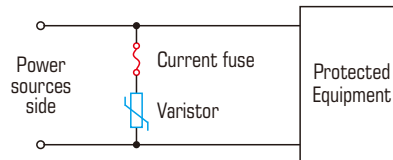

5) 温度保险丝

Concerning thermal fuse

将压敏电阻器与温度保险丝连接时，用户端请尽量选用热结合较好的保险丝。

Set a thermal fuse to get high thermal conductivity with varistor.

2.2. 使用环境

Operating environments

1) 请在规定的工作温度范围内使用，如果工作温度超出其范围，请对压敏电阻器进行降额使用(或者依据业务人员的指引选择更高工作温度的压敏电阻器)。

Please use it within the specified operating temperature range. If the working temperature is outside its operating temperature range, use the derating of varistor (or select higher operating temperature varistors guidance based business personnel).

下图为其降额曲线图。

The figure below shows the derating curve.

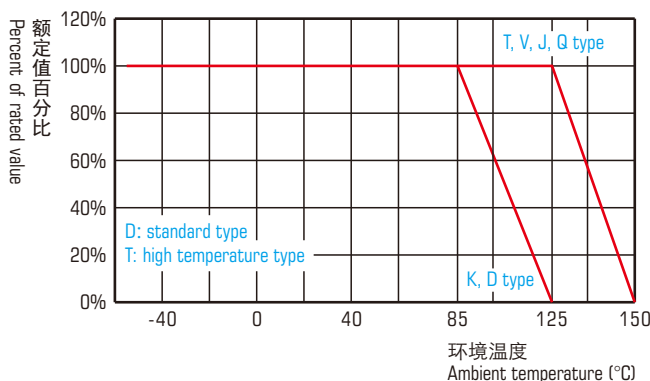

请注意：额定值包括最大连续工作电压、耐冲击电流、最大能量及额定功率。

Please note: rated value includes maximum continuous operating voltage, withstanding surge current, maximum energy and rated power.

举例说明，当一个标准型(D型)的压敏电阻器使用于环境温度为95°C时，其超出规定的使用温度10°C，此时上述额定值降额25%。

For example, when a standard type (D type) varistor is used at an ambient temperature of 95°C, it exceeds the specified operating temperature of 10°C. the above rated value derated by 25%.

2) 压敏电阻器不可在室外使用。

The varistor is designed to be used indoors. Do not use it exposed outdoors.

3) 不可在阳光直射场所、发热源附近或温度超过使用温度范围的场所使用。

Do not use the varistor in places exposed to temperatures beyond the operating temperature range, such as places exposed to sunlight and vicinities of heating equipment.

4) 不可在淋雨、蒸汽、高湿度的场所使用。

Do not use the varistor in places exposed to high temperatures and high humidity, such as places exposed directly to rain, wind, dew condensation, and vapor.

5) 不可在粉尘或盐分较多的场所以及被腐蚀性气体污染的环境中使用。

Do not use the varistor in dusty and salty places and atmospheres polluted by corrosive gases.

安全注意事项 SAFETY PRECAUTIONS

2.3. 加工条件

Processing conditions

- 1) 不可采用可能导致外涂层树脂劣化的溶剂（稀释剂、丙酮等）进行清洗。
Do not wash the varistor by such solvents (thinner, acetone, etc.) as its exterior resin deteriorates.
- 2) 不可施加可能导致外涂层树脂或元件出现破损的冲击或撞击、压力。
Do not apply a strong vibration or shock (by falling, etc.) to the varistor, cracking to its exterior resin and element may occur.
- 3) 将压敏电阻器进行树脂镀膜（含护膜塑模）时，不可使用可能导致压敏电阻器劣化的树脂。
When coating the varistor with resin (including molding), do not use such resin.
- 4) 压敏电阻器外涂层树脂附近的引线部位不可进行强烈折弯或施加外力。
Do not bend the varistor lead wires at the position close to its varistor exterior resin, or apply external force to the position.
- 5) 焊接时，请在如下条件下进行。且不可将构成压敏电阻器的焊接部位或绝缘材料熔化。
When soldering the varistor lead wires, follow the recommended conditions and do not melt the solder and insulating materials constituting the varistor.

焊接方式 Soldering method	推荐条件 Recommended condition	注意事项 Attention item
波峰焊 Flow soldering	260°C, 5秒以内 260°C, within 5s	引线型不是回流焊对象产品 Lead wires type is not reflow soldering object part.

上述以外的条件下使用时，请用户端自行确认。但不得破坏压敏电阻器内部焊锡结构，而导致压敏电阻器失效或烧毁。

For use other than the above conditions, please the client to confirm. However, the internal solder structure of the varistor must not be damaged, resulting in the loss or burning of the varistor.

仅限进行1次返工，烙铁温度320°C以下，时间控制在5秒以内。

Only 1 times rework, soldering iron temperature should not exceed 320°C and should not be applied for more than 5s.

■ 推荐焊接条件

Soldering temperature-time profile to recommend

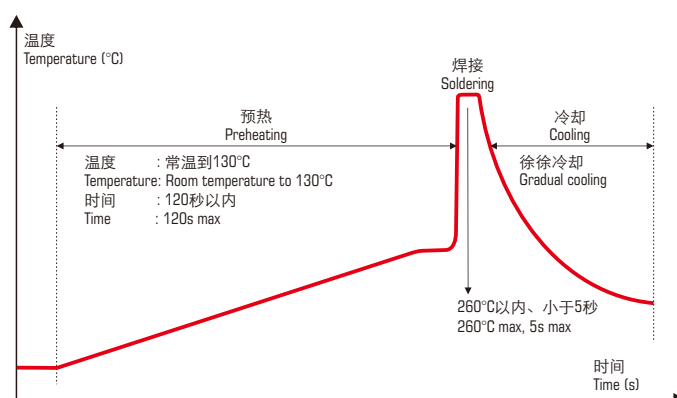

图：波峰焊接推荐条件

Fig.: Wave-soldering temperature-time profile to recommend

2.4. 长期保管

Long-term storage

- 1) 压敏电阻器不可保存在高温、高湿场所。保存场所室温40°C以下，湿度75%RH以下，保存期限为2年。
Do not store the varistor under high temperature and high humidity. Store it at a temperature up to 40 °c and at humidity below 75% rh, and use it within two years.
长期间保管（2年以上）时，使用时请确认产品的可焊性。
Before using the varistor that has been stored for a long period (two years or longer), confirm the solderability.
- 2) 不可保存在腐蚀性气体（硫化氢、亚硫酸、氯气、氨气等）环境中。
Avoid atmospheres full of corrosive gases (hydrogen sulfide, sulfurous acid, chlorine, ammonia, etc.).
- 3) 保存场所避免阳光直射、结露等。
Avoid direct sunlight and dew condensation.