

SURGING

紹 鑫 實 業



Surge Arresters

陶瓷气体放电管

SF90 Series

Gas Discharge Tube - SF90 Series



Gas discharge tubes (GDT) use noble gasses enclosed in ceramic tubes to provide an alternate circuit path for voltage spikes. The ceramic envelope and with nickel connectors allow for high loads and Surging offers products that function at 20KA,40KA,50KA,60KA,100KA&150KA. The breakdown voltages of the devices have a wide range (up to 20% tolerance). Major applications are high frequency telecommunication lines, stations, security systems, HID and high quality Surge Protection Devices (SPD).

Features

- RoHS & HF compliant
- Size: 7.6mm*5.0mm*5.0mm
- DC Spark-over voltage: 75~1100V
- Stable breakdown voltage.
- High insulation resistance.
- High holdover voltage.
- Large absorbing transient current capability.
- Low Capacitance
- Micro-Gap Design

Recommended Applications

- Cable Modem
- xDSL
- Set-Top Box
- Satellite and CATV equipment
- Power supplier
- Consumer electronics
- General telecom equipment

Product Name

SF90 - 230X

Series:
SF9系列: $\phi 5 * 5 * 7.6$

Lead Type:
0=SMD
3=Thrust

DC Line Voltage:
90X=90V
230X=230V
102X=1000V

Gas Discharge Tube - SF90 Series

Electrical Characteristics

Part Number	DC Spark-over Voltage	Max. Impulse Breakdown Voltage		Max. Impulse Discharge Current (8/20 μ s)		Impulse Life (10/1000 μ s)	Normal Alternating Discharge Current		DC Holdover Voltage	Minimum Insulation Resistance	Maximum Capacitance (1MHz)
	100V/S	100V/ μ s	1KV/ μ s	1 time	10 times	100A	50Hz, 1Sec	Single 9 Cycles			
	(V)	(V)	(V)	(KA)		(Times)	(A)				
SF90-75X	75 \pm 20%	600	700	10	5	300	5	30	52	1	2
SF90-90X	90 \pm 20%	500	600	10	5	300	5	30	52	1	2
SF90-120X	120 \pm 20%	500	600	10	5	300	5	30	80	1	2
SF90-150X	150 \pm 20%	500	600	10	5	300	5	30	80	1	2
SF90-200X	200 \pm 20%	600	700	10	5	300	10	60	135	1	2
SF90-230X	230 \pm 20%	600	700	10	5	300	10	60	135	1	2
SF90-250X	250 \pm 20%	600	700	10	5	300	10	60	135	1	2
SF90-350X	350 \pm 20%	650	750	10	5	300	10	60	135	1	2
SF90-400X	400 \pm 20%	700	800	10	5	300	10	60	135	1	2
SF90-420X	420 \pm 20%	700	800	10	5	300	10	60	135	1	2
SF90-470X	470 \pm 20%	800	900	10	5	300	10	60	135	1	2
SF90-600X	600 \pm 20%	900	1000	10	5	300	5	30	135	1	2
SF90-800X	800 \pm 20%	1150	1400	10	5	300	5	30	135	1	2
SF90-112X	1100 \pm 20%	1450	1750	10	5	300	5	30	135	1	2

DC Spark-over Voltage	DC Measuring Voltage
75-90V	50V
120-400V	100V
420-1100V	250V

Gas Discharge Tube - SF90 Series

Product size (Unit:mm)

Dimension

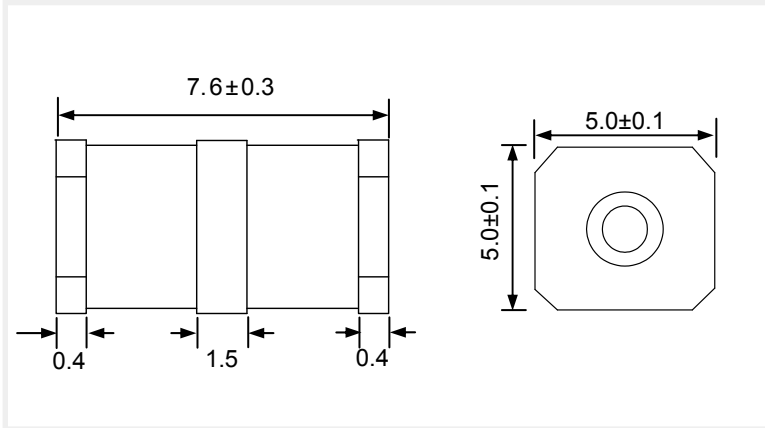

Recommended Pad Size

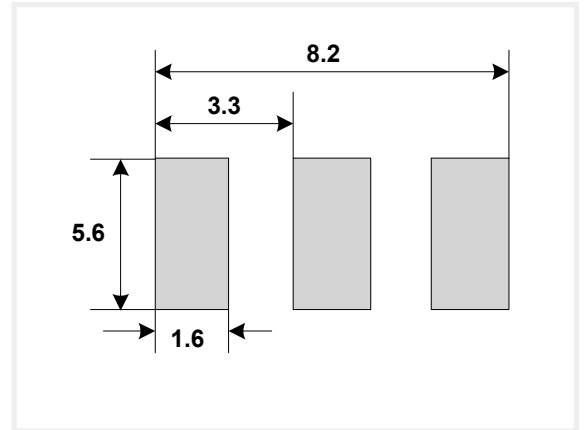

Packaging Taping

Unit:mm

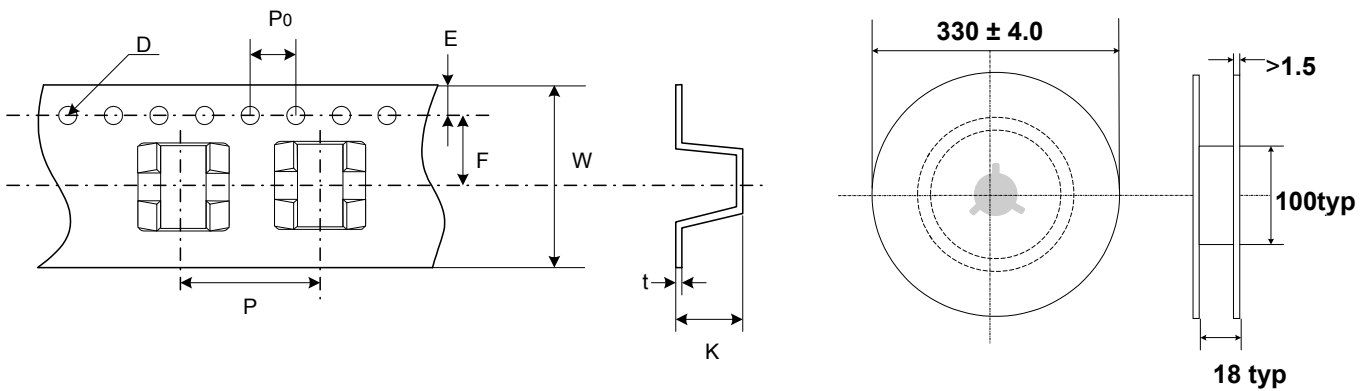

Quantity: 1000pcs per reel (13")

Item	P	PO	W	F	E	D	K	t
Spec.	12.0	4.0	16.0	7.5	1.75	$\Phi 1.55$	6.7	0.5
Tolerance	± 0.1	± 0.1	± 0.3	± 0.1	± 0.1	± 0.05	± 0.1	± 0.05