

Features

- The plastic package carries UL Flammability Classification 94V-0
- For surface mounted applications
- Low reverse leakage
- Built-in strain relief, ideal for automated placement
- High forward surge current capability
- High temperature soldering guaranteed:260°C/10 seconds at terminals



SMC (DO-214AB)

Mechanical Characteristics

- Case: SMC(DO-214AB) package molded plastic body over passivated chip
- Terminals: Solder plated, solderable per MIL-STD-750, Method 2026
- Polarity: Color band denotes cathode end
- Mounting Position: Any

Absolute Maximum Ratings and Electrical Parameters (TA=25°C unless otherwise specified)

PARAMETER	SYMBOL	S3AC	S3BC	S3DC	S3GC	S3JC	S3KC	S3MC	UNIT	
Maximum repetitive peak reverse voltage	V_{RRM}	50	100	200	400	600	800	1000	V	
Maximum RMS voltage	V_{RMS}	35	70	140	280	420	560	700	V	
Maximum DC blocking voltage	V_{DC}	50	100	200	400	600	800	1000	V	
Maximum average forward rectified current	I_{AV}	3							A	
Peak forward surge current ^(NOTE1)	I_{FSM}	100							A	
Maximum instantaneous forward voltage at 3A	V_F	1.1							V	
Maximum DC reverse current at rated DC blocking voltage	$T_A=25\text{ }^\circ\text{C}$	I_R	5							μA
	$T_A=100\text{ }^\circ\text{C}$	I_{RT}	50							μA
Typical junction capacitance ^(NOTE 2)	C_J	45							pF	
Typical Thermal Resistance Junction to Ambient ^(NOTE3)	$R_{\theta JA}$	55							$^\circ\text{C/W}$	
Typical Thermal Resistance Junction to Lead ^(NOTE3)	$R_{\theta JL}$	15							$^\circ\text{C/W}$	
Operating Temperature Range	T_J	-55 to 150							$^\circ\text{C}$	
Storage Temperature Range	T_{STG}	-55 to 150							$^\circ\text{C}$	

Note1: 8.3ms single half sine-wave superimposed on rated load

Note2: Measured at 1MHz and applied reverse voltage of 4.0V DC.

Note3: PCB. mounted with 16x16mm copper pad areas

Rating And Characteristic Curves (TA=25°C unless otherwise noted)

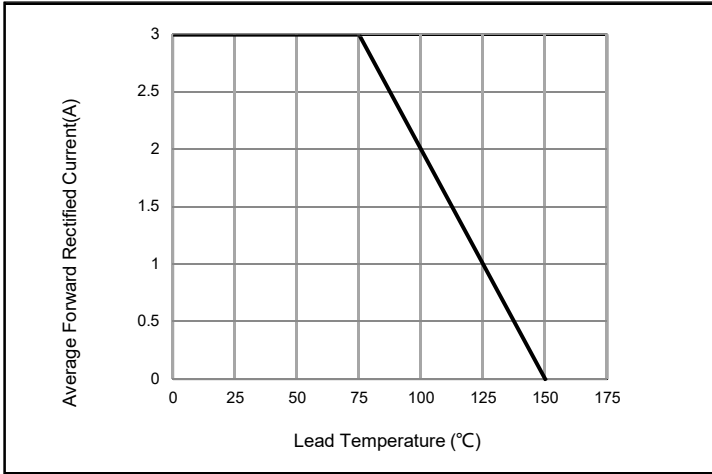

Fig. 1 - Forward Current Derating Curve

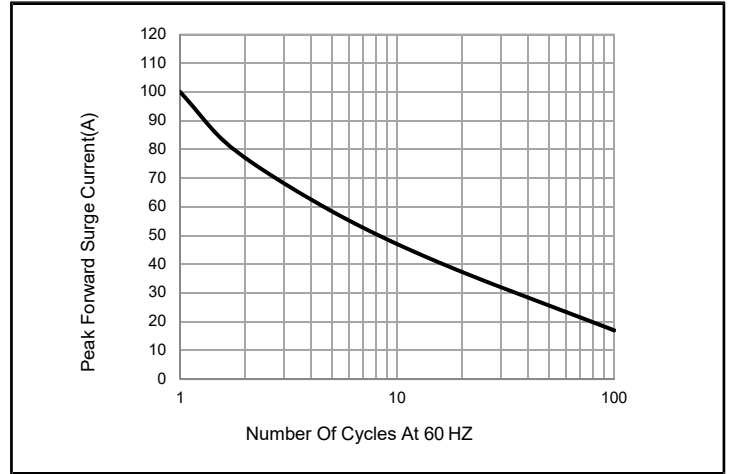

Fig. 2 - Maximum Non-Repetitive Peak Forward Surge Current

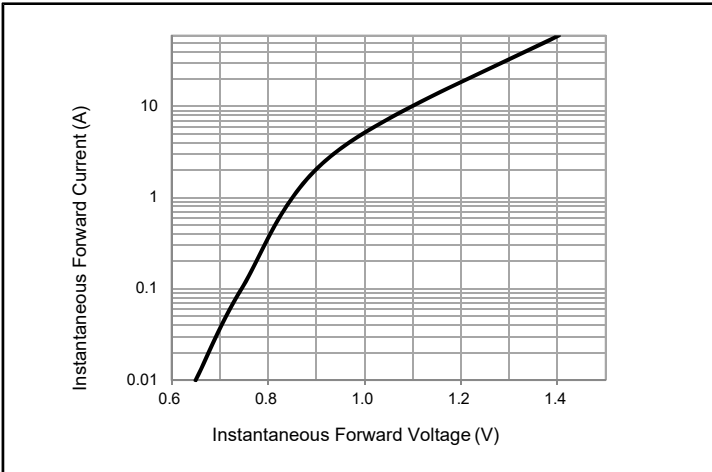

Fig. 3 - Typical Instantaneous Forward Characteristics

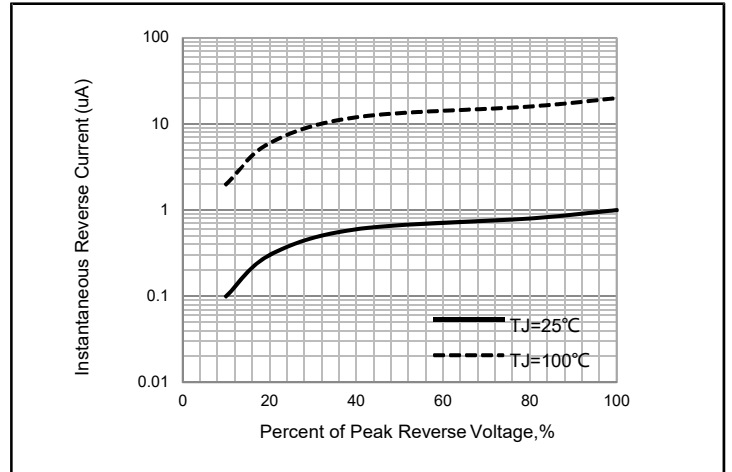

Fig. 4 - Typical Reverse Characteristics

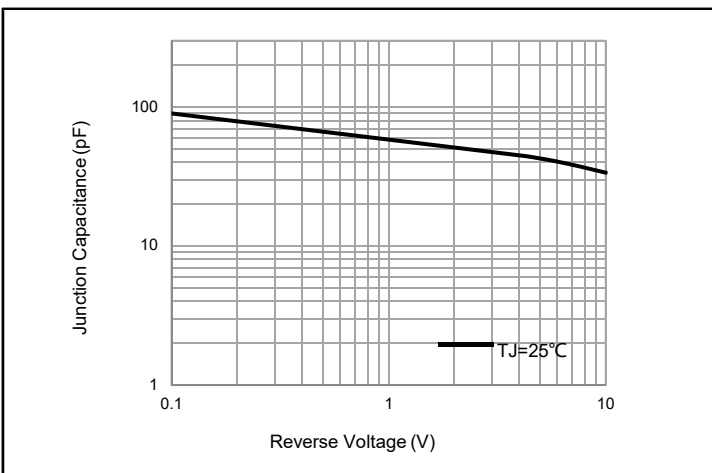

Fig. 5 - Typical Junction Capacitance

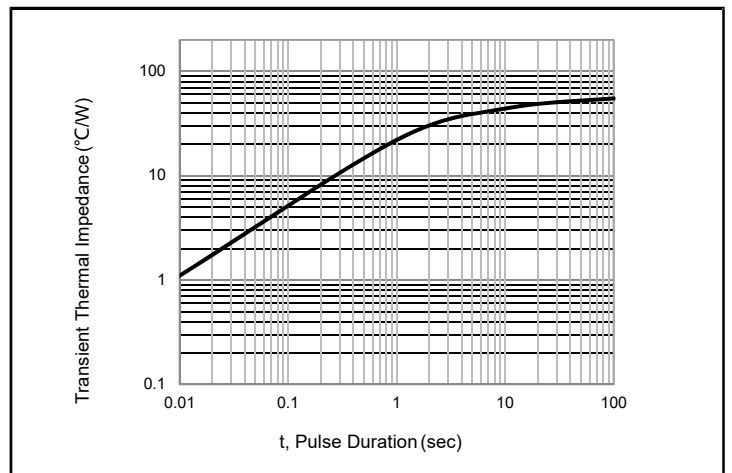
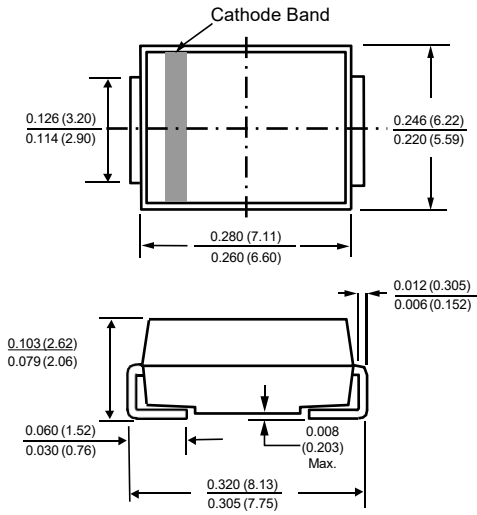

Fig. 6 - Typical Transient Thermal Impedance

Package Outline Dimensions in inches (millimeters)

SMC (DO-214AB)



Mounting Pad Layout

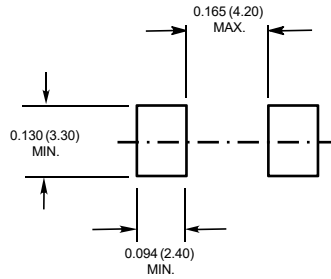

Soldering Parameters

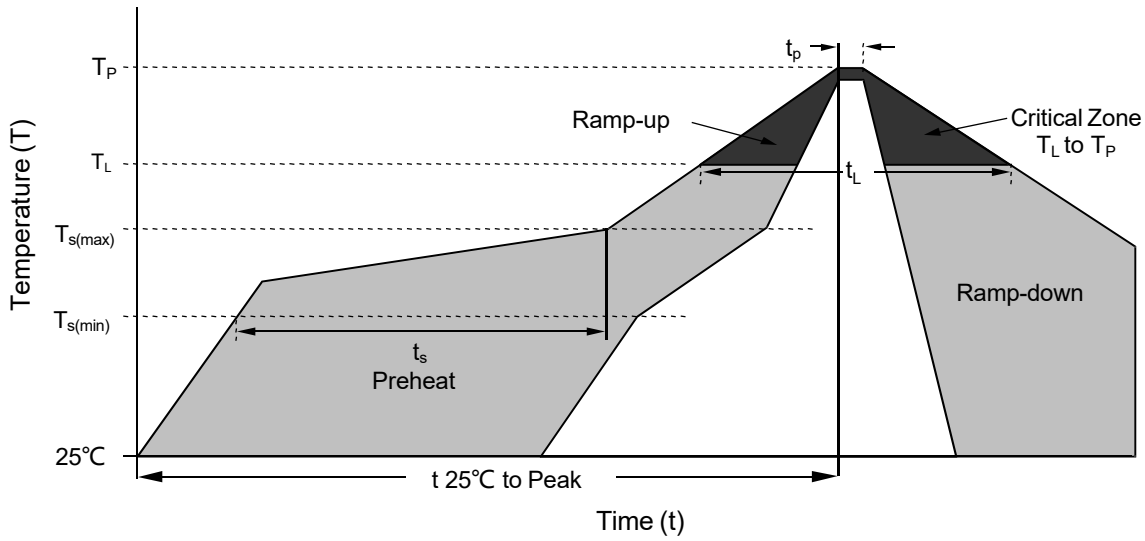

Reflow Condition		Lead-free assembly
Pre Heat	- Temperature Min ($T_{s(min)}$)	150°C
	- Temperature Max ($T_{s(max)}$)	200°C
	- Time (min to max) (t_s)	60 – 180 secs
Average ramp up rate (Liquidus Temp (T_L) to peak)		3°C/second max
$T_{s(max)}$ to T_L - Ramp-up Rate		3°C/second max
Reflow	- Temperature (T_L) (Liquidus)	217°C
	- Time (t_L)	60 – 150 secs
Peak Temperature (T_P)		260 ^{+0/-5} °C
Time within 5°C of actual peak Temperature (t_p)		20 – 40 secs
Ramp-down Rate		6°C/second max
Time 25°C to peak Temperature (t)		8 minutes Max.
Do not exceed		260°C

Part Numbering System

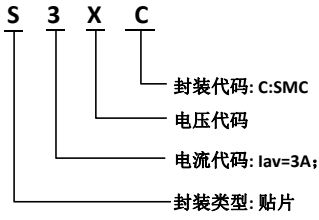

Part Marking System

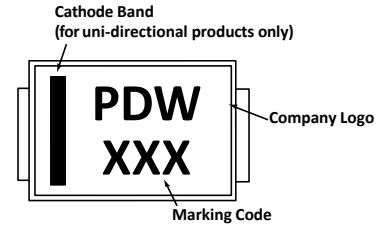

Summary of Packing Options

Package	Packing Description	Packing Quantity
SMC	Tape/Reel, 13" reel	3000

Tape and Reel Specification

