

1 2 3 4 5 6 7 8

A

B

C

D

E

A

B

C

D

E

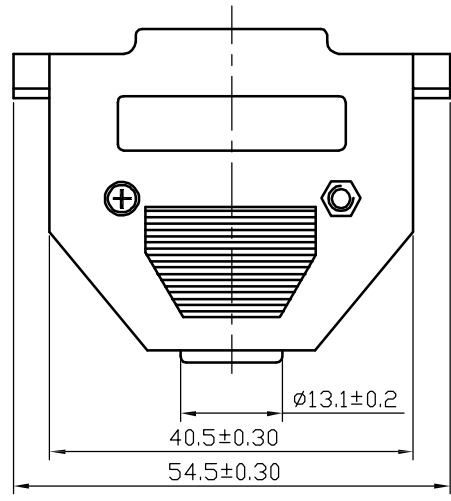

① 25P 塑膠本體

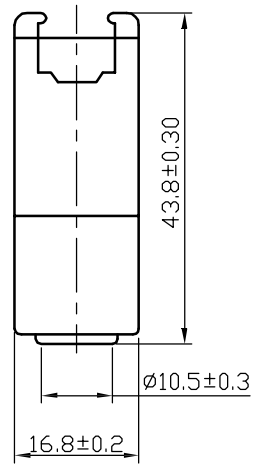

SPECIFICATIONS:  
 Current rating: NONE  
 Voltage rating: NONE  
 Contact resistance: NONE  
 Insulation resistance: 1000M ohm MIN  
 Withstanding voltage: 1000V AC for one minute  
 Operating temperature range: -40°C~+85°C

MATERIAL AND FINISH:  
 Insulator: ABS or HIPS(UL94V-0)  
 Contact: Copper Alloy  
 Finish: Zn Plated or Cr Plated

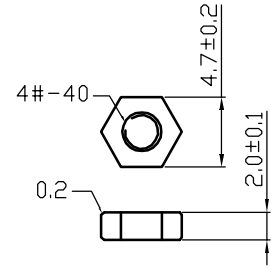

② 塑膠螺母(通用)

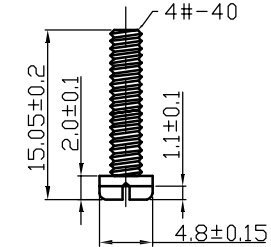

③ 塑殼螺絲(通用)

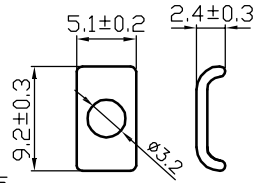

④ 卡片(通用)

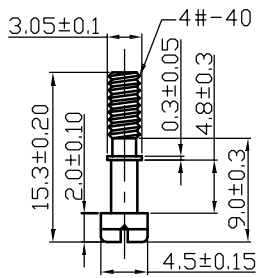

⑤ 卡片螺絲(通用)

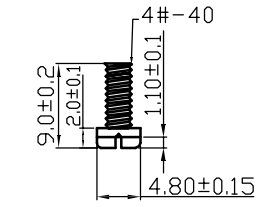

⑥ 線夾螺絲(通用)

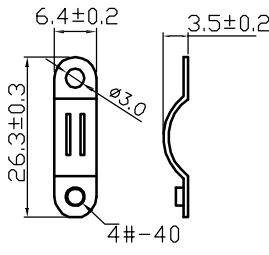

⑦ 線夾(25Pin)

PART NO.

Z-SUB-B0\*0-002\*-\*\* \*

NO OF CONTACTS

- A=9PIN
- B=15PIN
- C=25PIN
- E=37PIN

FITTING PLATED

- N=NI
- P=COLOR Zn
- Q=BLUE Zn
- R=Cr<sup>3+</sup>

- MARK
- 0=NO MARK
- 2=NEXTRON MARK
- INSULATOR COLOR
- 0=BLACK
- 8=GREY
- L=Lvory White
- INSULATOR MATERIAL
- D=ABS, NO PLATED
- E=ABS, Cr PLATED
- H=HIPS, NO PLATED

UNITS ■mm □INCH		NAME: D-SUB HOOD 25P 塑膠殼及配件		NEXTRON NEXTRONICS ENGINEERING CORP.	
GENERAL TOLERANCES: (UNLESS SPECIFIED)		PART NO: R-SUBB0*0002*****		TITLE: CUSTOMER DWG	
	mm	INCH	APPD:	DWG NO: ** C	
4 PLACE	±**	±.**	CHKD:		
3 PLACE	±**	±.**	DRAWN: 陳惠枝 7/9'15	SCALE: 1/3	SHEET: 1/1
2 PLACE	±0.05	±.**		REV.:	A
1 PLACE	±0.1	±.**			
ANGULAR:	X°±2°	X°±**			

A	NEW RELEASED	7/9'15	
REV.	DESCRIPTION	DATE	APPD