

GaAs pHEMT MMIC 1 WATT POWER AMPLIFIER, DC - 22 GHz

Typical Applications

The HMC797APM5E is ideal for:

- Test Instrumentation
- Military & Space
- Fiber Optics

Features

- High P1dB Output Power: +29 dBm
- High Psat Output Power: +31 dBm
- High Gain: 15 dB
- High Output IP3: +41 dBm
- Supply Voltage: +10 V @ 400 mA
- 50 Ohm Matched Input/Output
- 32 Lead 5x5 mm SMT Package: 25 mm²

Functional Diagram

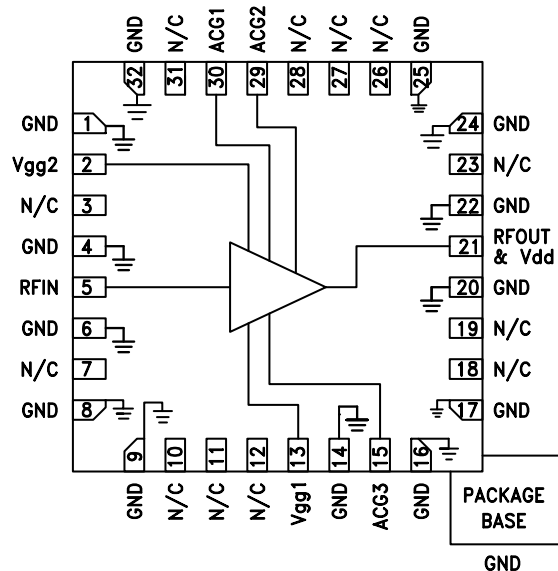

General Description

The HMC797APM5E is a GaAs MMIC pHEMT Distributed Power Amplifier which operates between DC and 22 GHz. The amplifier provides 15 dB of gain, +29 dBm of output power at 1 dB gain compression, +31 dBm of saturated output power, and 25% PAE while requiring 400 mA from a +10 V supply. With up to +41 dBm of output IP3, the HMC797APM5E is ideal for high linearity applications in military and space as well as test equipment where high order modulations are used. This versatile PA exhibits a positive gain slope from 2 to 20 GHz making it ideal for EW, ECM, Radar and test equipment applications. The HMC797APM5E amplifier I/Os are internally matched to 50 Ohms facilitating integration into multi-chip-modules (MCMs), is packaged in a leadless QFN 5x5 mm surface mount package, and requires no external matching components.

Electrical Specifications, $T_A = +25^\circ\text{C}$, $V_{dd} = +10\text{V}$, $V_{gg2} = +3.5\text{V}$, $I_{dd} = 400\text{mA}^*$

Parameter	Min.	Typ.	Max.	Min.	Typ.	Max.	Min.	Typ.	Max.	Units
Frequency Range	DC - 12			12 - 18			18 - 22			GHz
Gain	12.5	14.5		13	15		13	15.5		dB
Gain Flatness		± 0.7			± 0.5			± 0.5		dB
Gain Variation Over Temperature		0.014			0.018			0.02		dB/°C
Input Return Loss		15			15			15		dB
Output Return Loss		13			15			13		dB
Output Power for 1 dB Compression (P1dB)	27	29		27	29		26	29		dBm
Saturated Output Power (Psat)		31			31			31		dBm
Output Third Order Intercept (IP3) *Measurement taken at Pout/Tone = + 18 dBm		42			41			41		dBm
Noise Figure		3.0			3.5			4		dB
Supply Current (Idd)		400			400			400		mA
Supply Voltage (Vdd)	8	10	11	8	10	11	8	10	11	V

* Adjust Vgg1 between -2 to 0 V to achieve Idd = 400 mA typical, Vgg1 = -0.55V Typical to achieve Idd = 400 mA.

**GaAs pHEMT MMIC
1 WATT POWER AMPLIFIER, DC - 22 GHz**

Broadband Gain and Return Loss

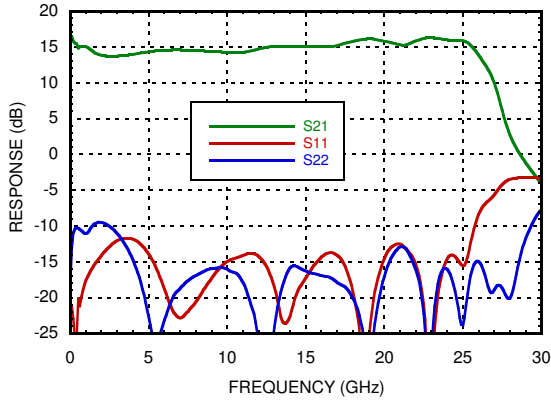

Low Frequency Gain and Return Loss

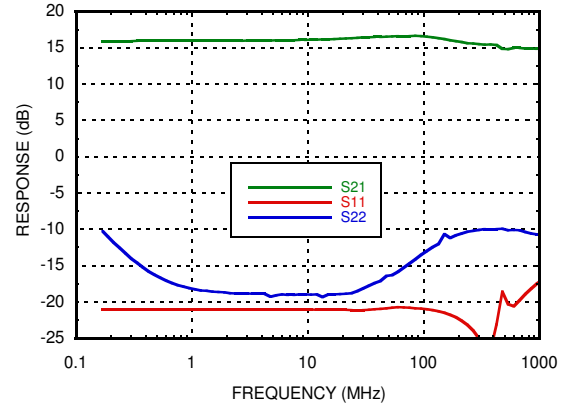

Gain vs. Temperature

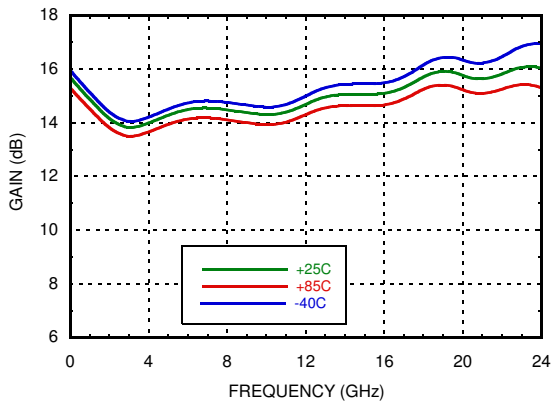

Gain vs. Vdd

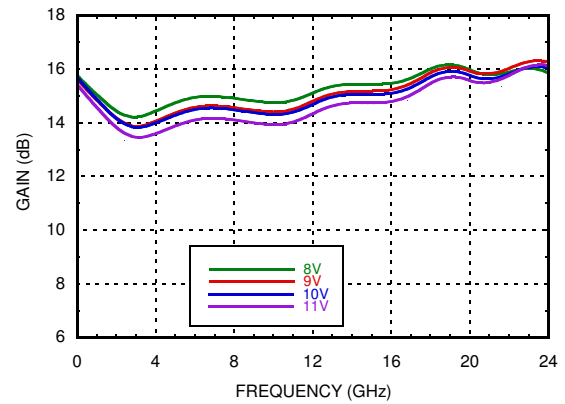

Gain vs. Idd

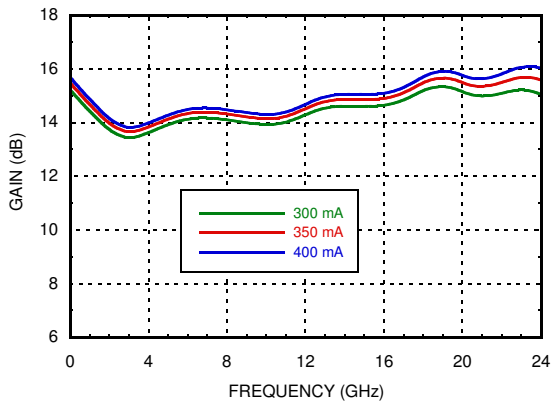

Input Return Loss vs. Temperature

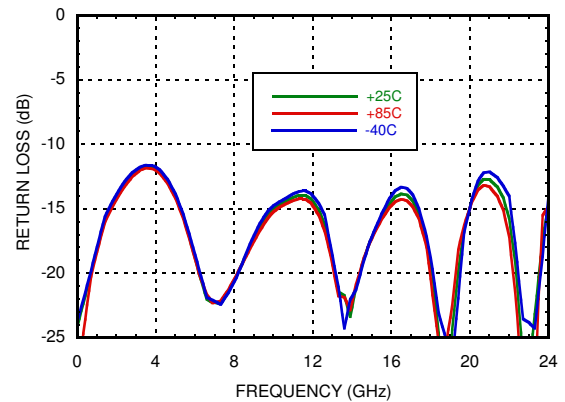

**GaAs pHEMT MMIC
1 WATT POWER AMPLIFIER, DC - 22 GHz**

Input Return Loss vs. Vdd

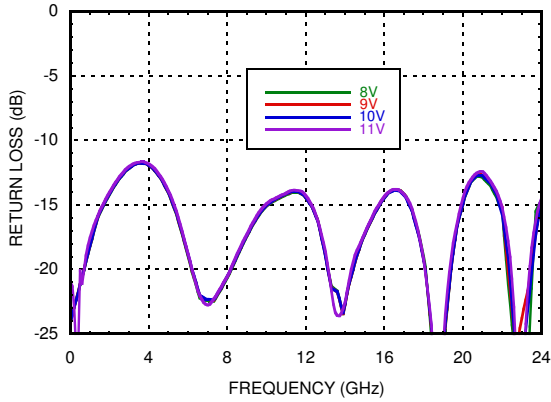

Input Return Loss vs. Idd

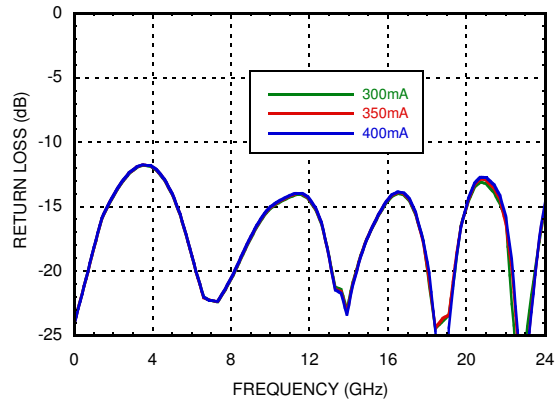

Output Return Loss vs. Temperature

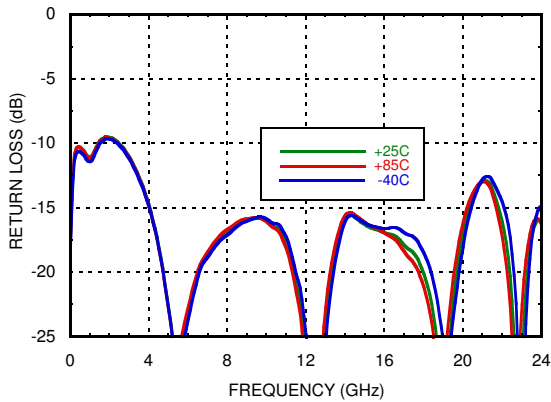

Output Return Loss vs. Vdd

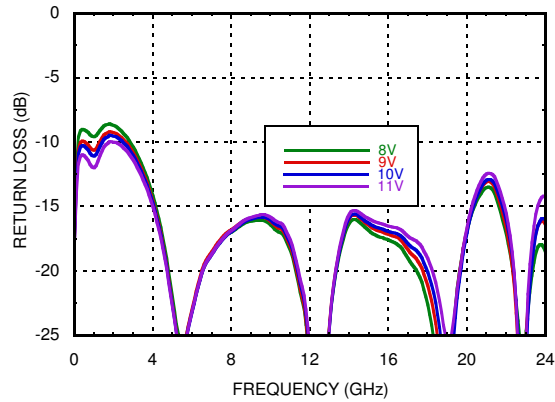

Output Return Loss vs. Idd

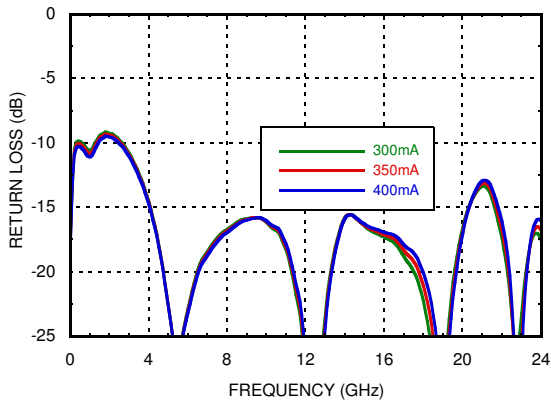

Reverse Isolation vs. Temperature

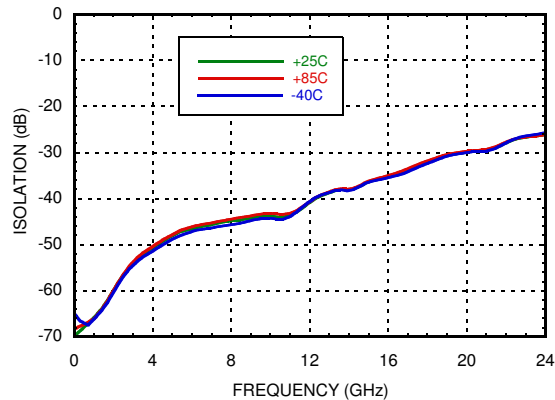

**GaAs pHEMT MMIC
1 WATT POWER AMPLIFIER, DC - 22 GHz**

Noise Figure vs. Temperature

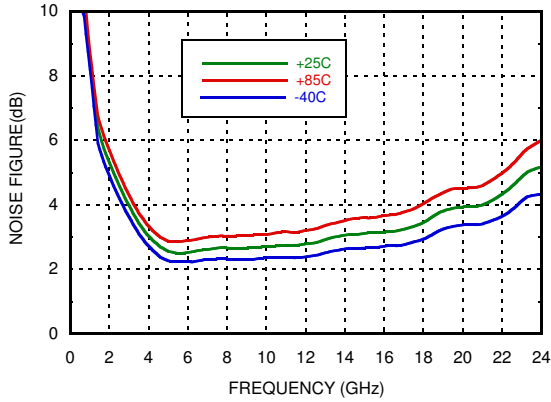

Noise Figure vs. I_{dd}

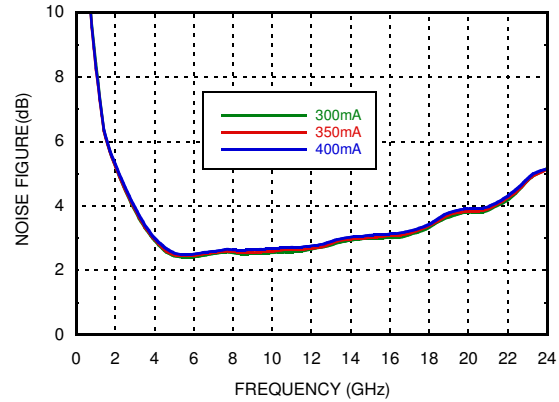

Low Frequency P_{1dB} vs. Temperature

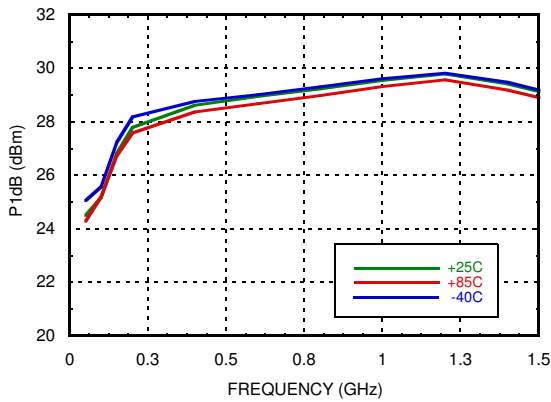

P_{1dB} vs. Temperature

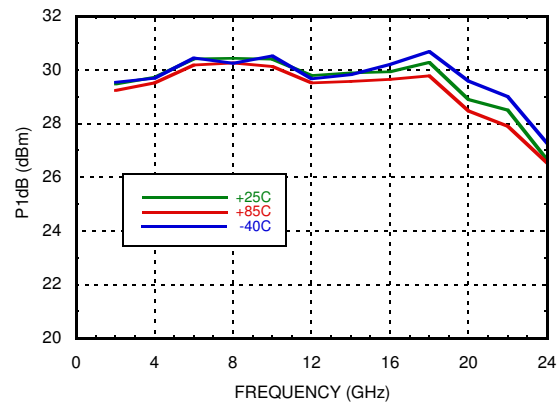

P_{1dB} vs. V_{dd}

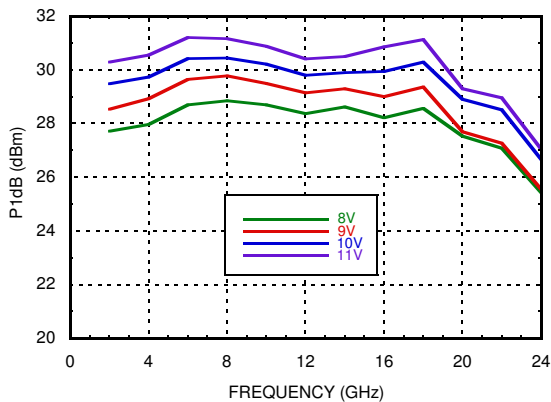

P_{1dB} vs. I_{dd}

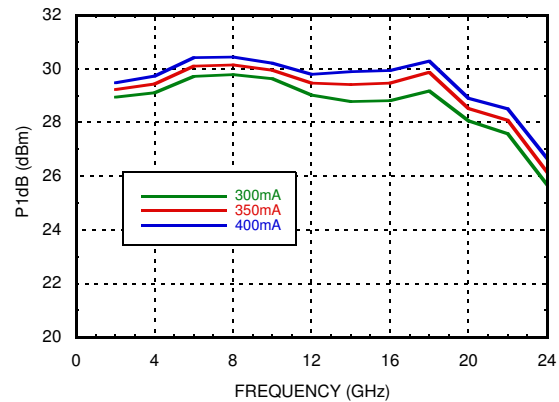

**GaAs pHEMT MMIC
1 WATT POWER AMPLIFIER, DC - 22 GHz**

Low Frequency Psat vs. Temperature

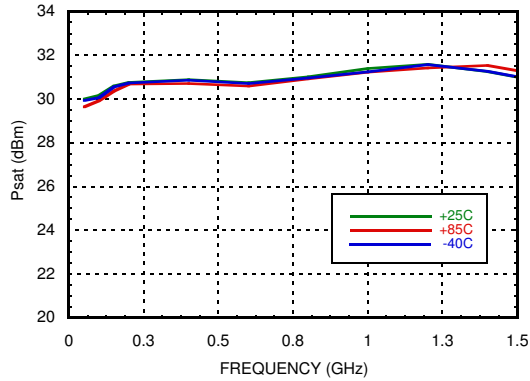

Psat vs. Temperature

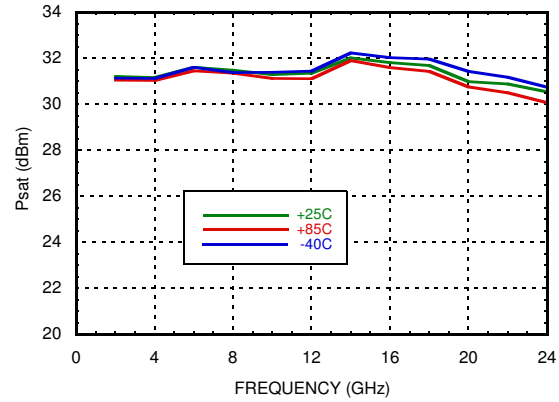

Psat vs. Vdd

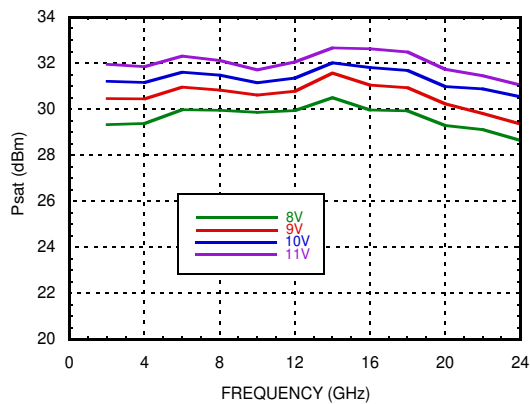

Psat vs. Idd

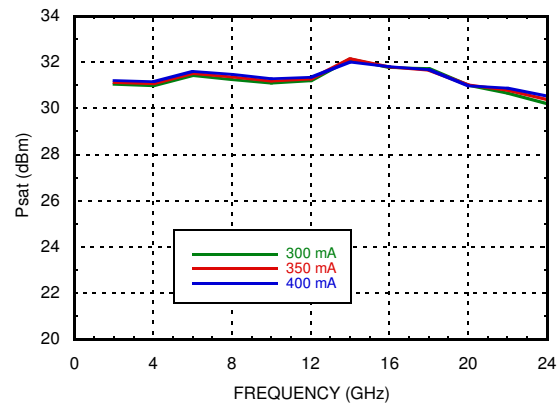

Power Compression @ 2 GHz

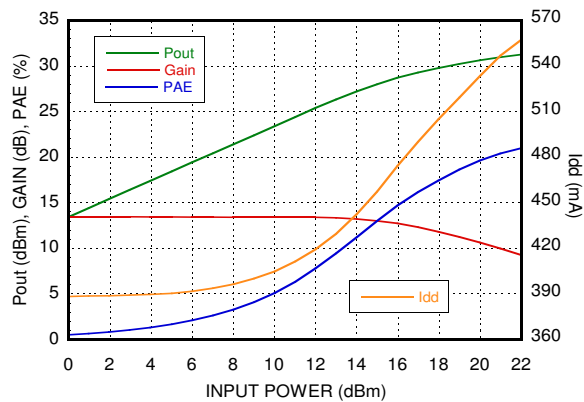

Power Compression @ 6 GHz

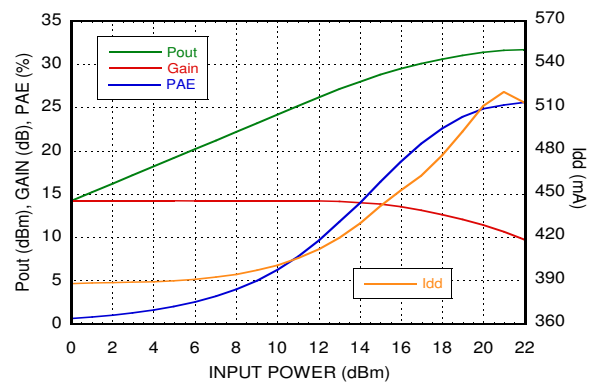

**GaAs pHEMT MMIC
1 WATT POWER AMPLIFIER, DC - 22 GHz**

Power Compression @ 10 GHz

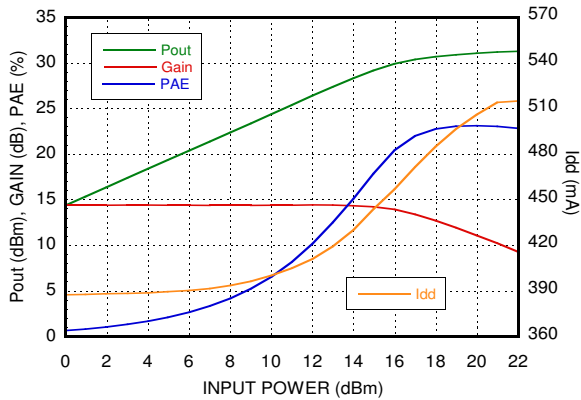

Power Compression @ 14 GHz

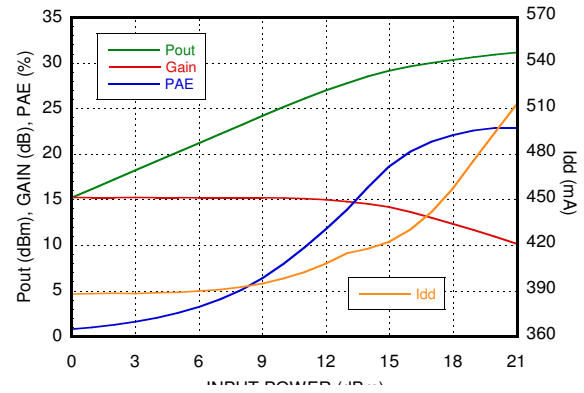

Power Compression @ 18 GHz

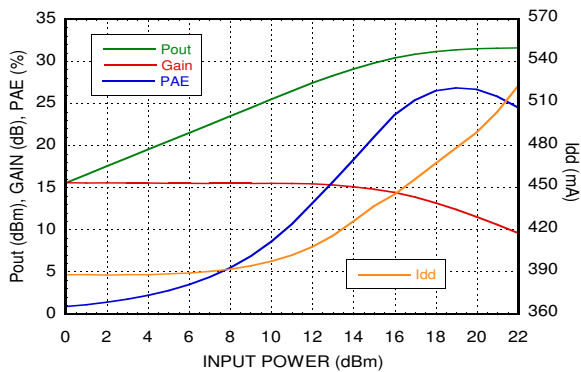

Power Compression @ 22 GHz

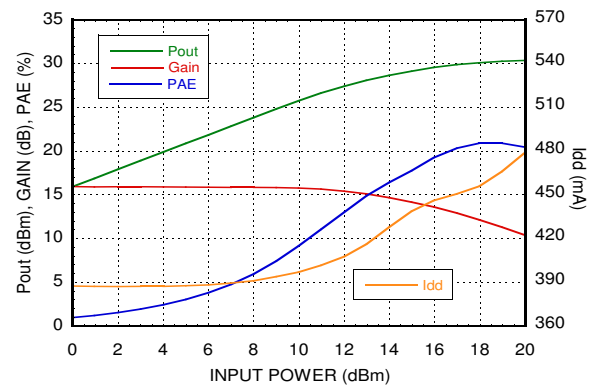

PAE @ Psat vs. Frequency

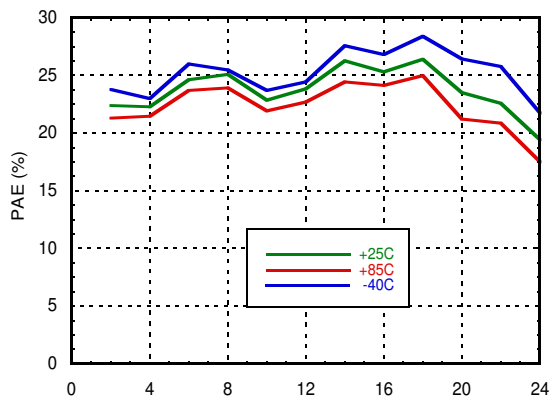

Power Dissipation @ 85 C

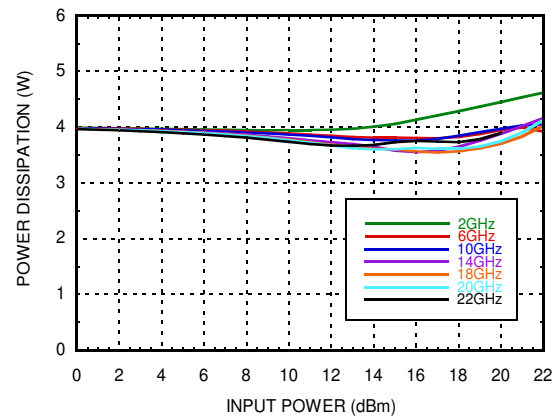

GaAs pHEMT MMIC 1 WATT POWER AMPLIFIER, DC - 22 GHz

Gain & Power vs. Vdd @ 2 GHz

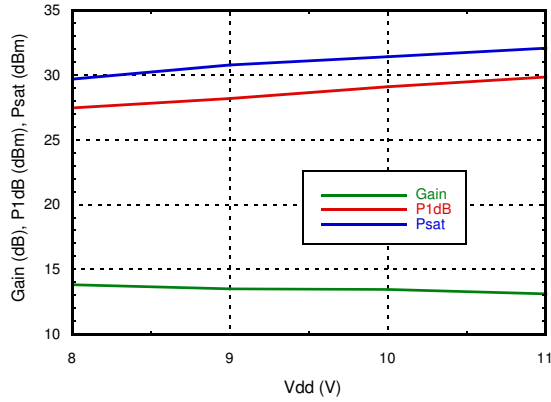

Gain & Power vs. Vdd @ 10 GHz

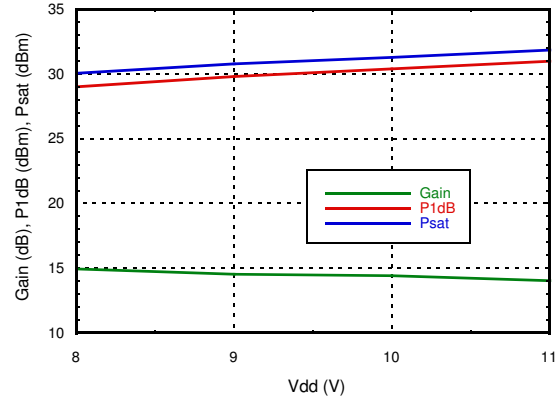

Gain & Power vs. Vdd @ 22 GHz

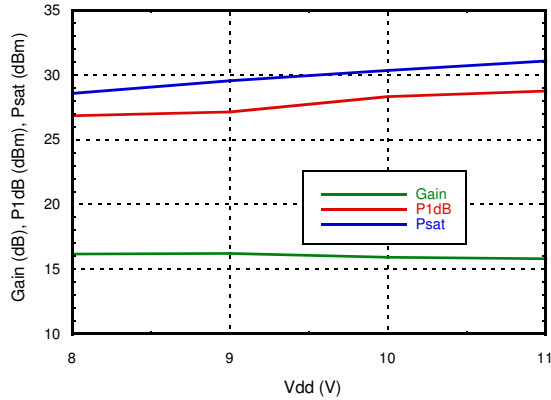

Gain & Power vs. Idd @ 2 GHz

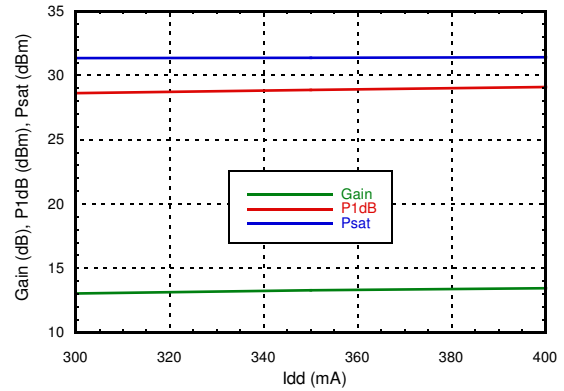

Gain & Power vs. Idd @ 10 GHz

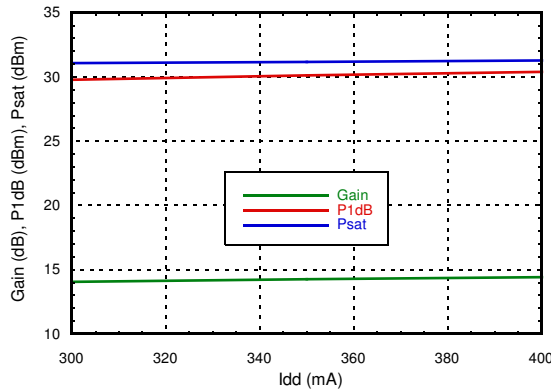

Gain & Power vs. Idd @ 22 GHz

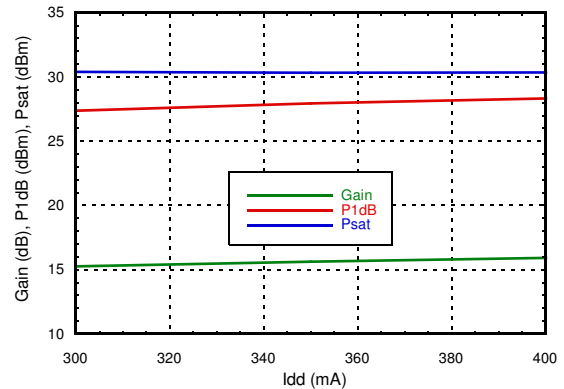

**GaAs pHEMT MMIC
1 WATT POWER AMPLIFIER, DC - 22 GHz**

OIP3 vs. Temperature
@ Pout / Tone = +18 dBm

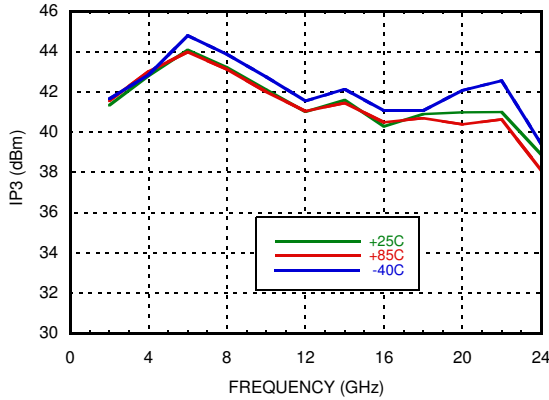

Low Frequency OIP3 vs. Temperature
@ Pout / Tone = +18 dBm

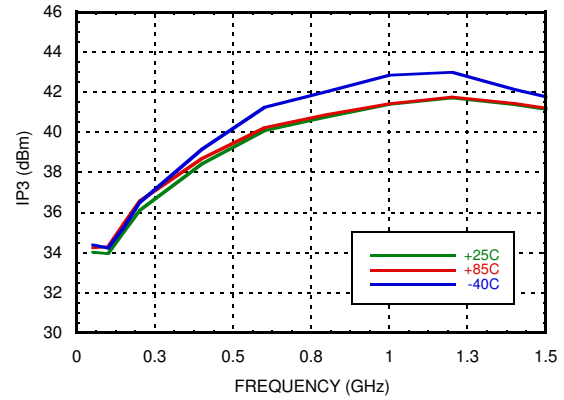

OIP3 vs. Vdd
@ Pout / Tone = +18 dBm

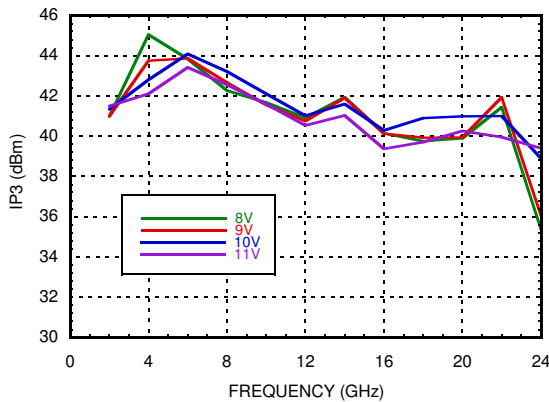

OIP3 vs. Idd
@ Pout / Tone = +18 dBm

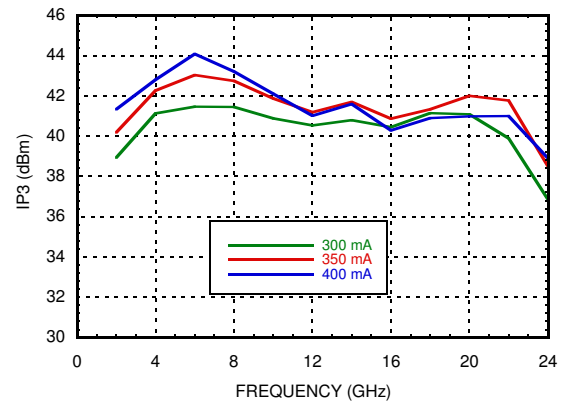

Output IM3 @ Vdd = +8 V

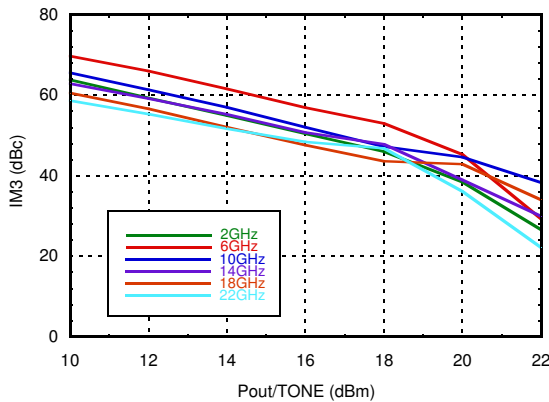

Output IM3 @ Vdd = +9 V

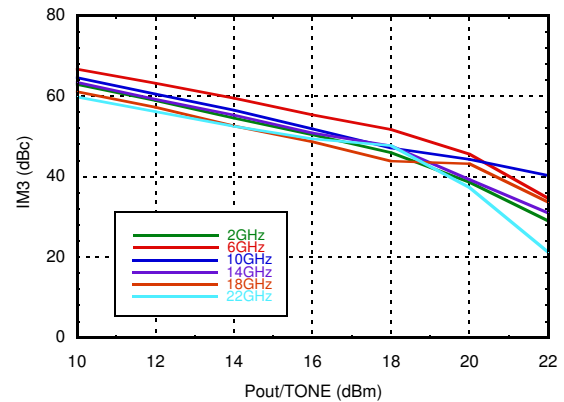

**GaAs pHEMT MMIC
1 WATT POWER AMPLIFIER, DC - 22 GHz**

1AMPLIFIERS - LINEAR & POWER - SMT

Output IM3 @ Vdd = +10 V

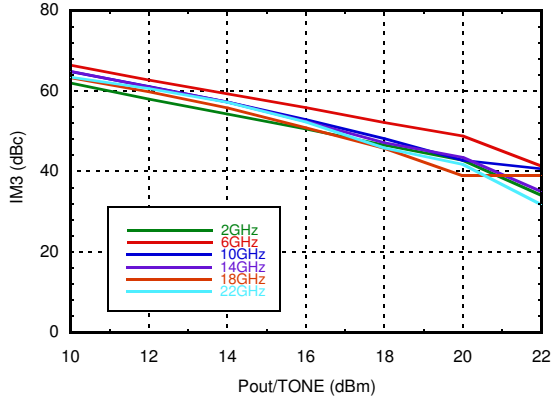

Output IM3 @ Vdd = +11 V

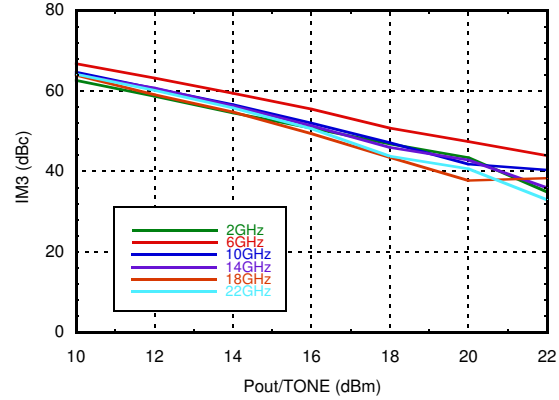

**OIP2 vs. Temperature
@ Pout / Tone = +18 dBm**

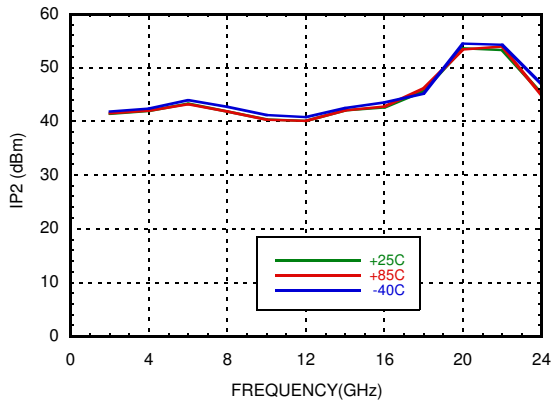

**OIP2 vs. Vdd
@ Pout / Tone = +18 dBm**

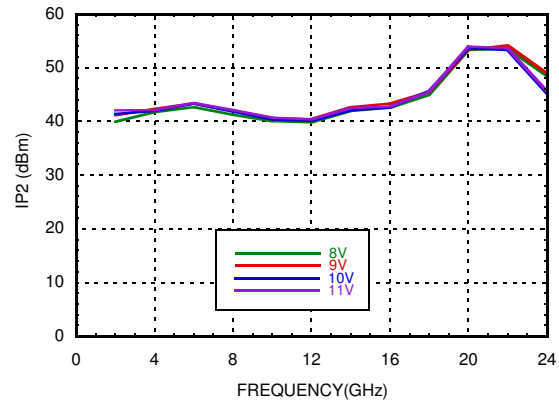

**OIP2 vs. Idd
@ Pout / Tone = +18 dBm**

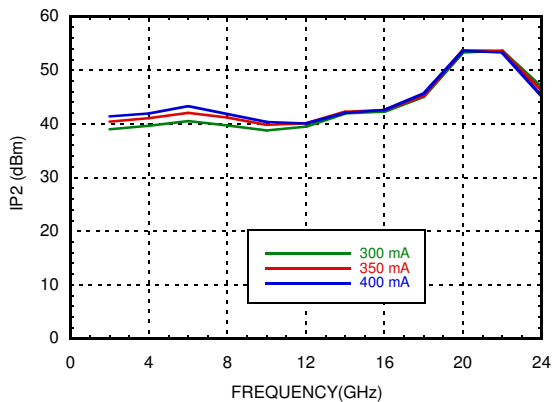

**Second Harmonics vs. Temperature
@ Pout = +18 dBm**

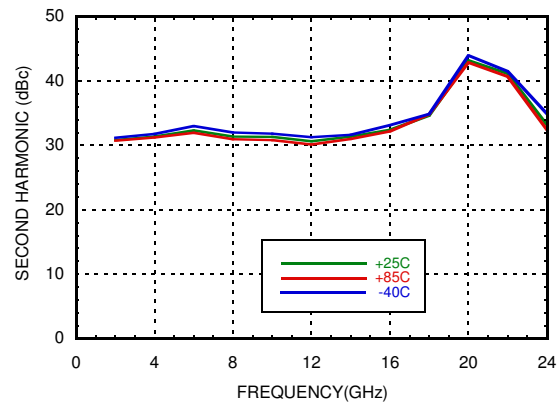

**GaAs pHEMT MMIC
1 WATT POWER AMPLIFIER, DC - 22 GHz**

**Second Harmonics vs. Vdd
@ Pout = +18 dBm**

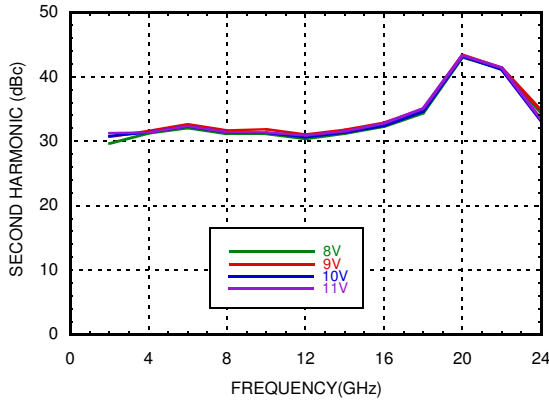

**Second Harmonics vs. Idd
@ Pout = +18 dBm**

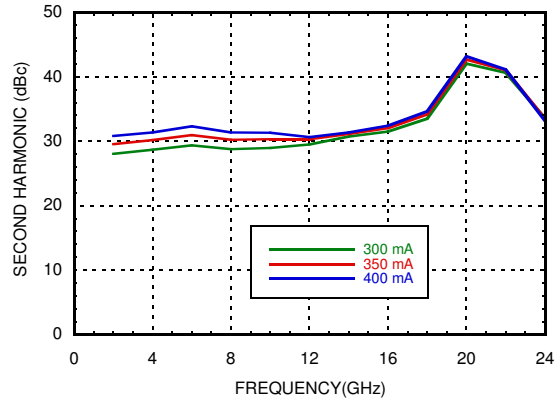

Second Harmonics vs. Pout

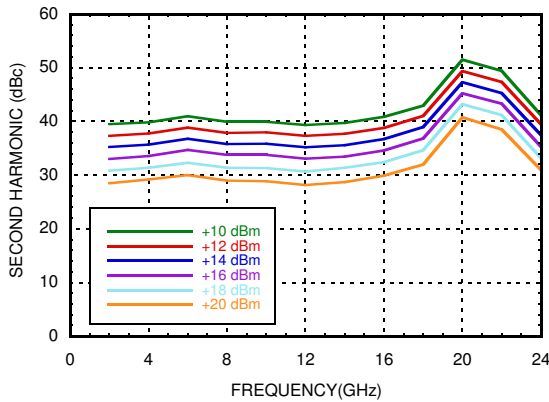

Igg1 vs. Input Power

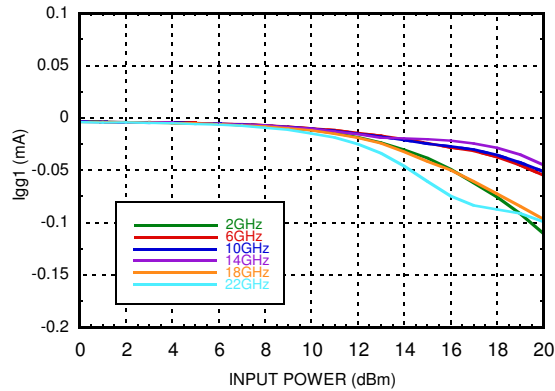

Igg2 vs. Input Power

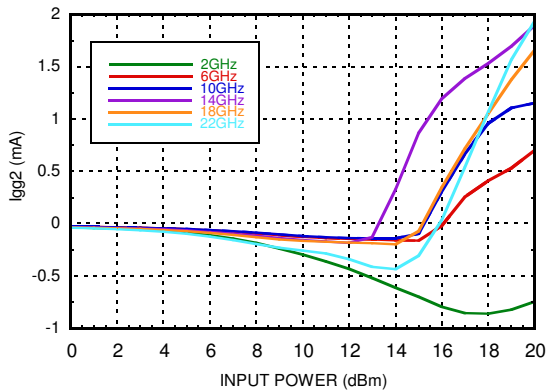

**Idd vs. Vgg1,
Representative of a Typical Device**

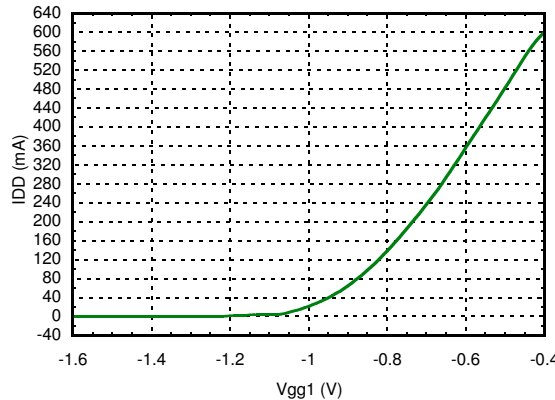

GaAs pHEMT MMIC 1 WATT POWER AMPLIFIER, DC - 22 GHz

Absolute Maximum Ratings

Nominal Drain Supply to GND	+12.0 V
Gate Bias Voltage (Vgg1)	-3.0 to 0 Vdc
Gate Bias Voltage (Vgg2)	+2.5 V to (Vdd - 5.5 V)
Continuous Pdiss (T= 85 °C) (derate 60 mW/°C above 85 °C)	5.37 W
RF Input Power	+27 dBm
Output Load VSWR	7:1
Storage Temperature	-65 to 150 °C
Operating Temperature	-40 to +85 °C
Max Peak Reflow Temperature	260 °C
ESD Sensitivity (HBM)	Class 1A - Passed 250V

Reliability Information

Junction Temperature to Main- tain 1 Million Hour MTTF	175 °C
Nominal Junction Temperature (T=85 °C, Vdd = 10 V)	152 °C
Thermal Resistance (channel to ground paddle)	16.75 °C/W

Stresses at or above those listed under Absolute Maximum Ratings may cause permanent damage to the product. This is a stress rating only, functional operation of the product at these or any other conditions above those indicated in the operational section of this specification is not implied. Operation beyond the maximum operating conditions for extended periods may affect product reliability.



ELECTROSTATIC SENSITIVE DEVICE
OBSERVE HANDLING PRECAUTIONS

Outline Drawing

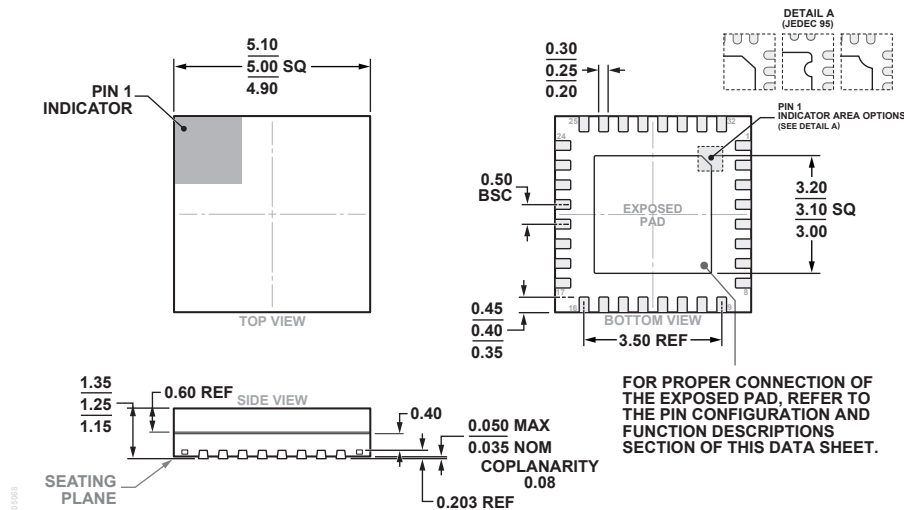

32-Lead Lead Frame Chip Scale Package [LFCSP_CAV]
5 mm x 5 mm and 1.25 mm Package Height
(CG-32-2)
Dimensions shown in millimeters

Package Information

Part Number	Package Body Material	Lead Finish	MSL Rating	Package Marking
HMC797APM5E	RoHS-compliant Low Stress Pre-Molded Plastic	NiPdAu	MSL3 [1]	HMC797A

[1] Max peak reflow temperature of 260 °C

GaAs pHEMT MMIC 1 WATT POWER AMPLIFIER, DC - 22 GHz

Pin Descriptions

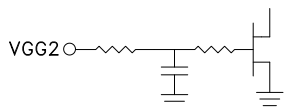
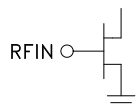
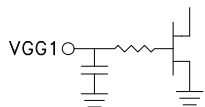
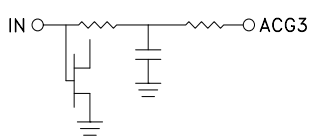
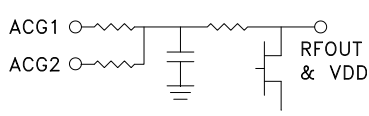
Pin Number	Function	Description	Interface Schematic
1, 4, 6, 8, 9, 16, 17, 20, 22, 24, 25, 32 Package Bottom	GND	These pins & exposed ground paddle must be connected to RF/DC ground.	
2	VGG2	Gate control 2 for amplifier. Attach bypass capacitor per application circuit herein. For nominal operation +3.5V should be applied to Vgg2.	
3, 7, 10 - 12, 14, 18, 19, 23, 26 - 28, 31	N/C	No connection required. These pins may be connected to RF/DC ground without affecting performance.	
5	RFIN	This pad is DC coupled and matched to 50 Ohms. Blocking capacitor is required.	
13	VGG1	Gate control 1 for amplifier. Attach bypass capacitor per application circuit herein. Please follow "MMIC Amplifier Biasing Procedure" application note.	
15	ACG3	Low frequency termination. Attach bypass capacitor per application circuit herein.	
21	RFOUT & VDD	RF output for amplifier. Connect DC bias (Vdd) network to provide drain current (Idd). See application circuit herein.	
29	ACG2	Low frequency termination. Attach bypass capacitor per application circuit herein.	
30	ACG1		

**GaAs pHEMT MMIC
1 WATT POWER AMPLIFIER, DC - 22 GHz**

Evaluation PCB

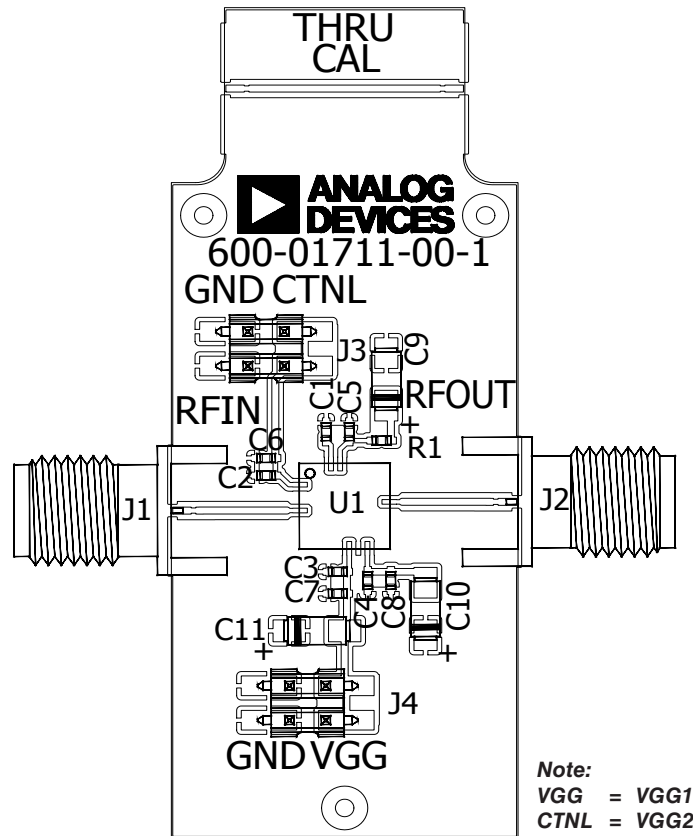

Evaluation Order Information

Item	Contents	Part Number
Evaluation PCB only	HMC797APM5E Evaluation PCB	EV1HMC797APM5

List of Materials for Evaluation Board

Item	Description
J1, J2	SMA Connectors
J3, J4	DC Pins
C1 - C4	100 pF Capacitor, 0402 Pkg.
C5, C8	10 kpF Capacitor, 0402 Pkg.
C9 - C11	4.7 μF Capacitor, Tantalum
R1, R2	0 OHM Resistor, 0402 Pkg
U1	HMC797APM5E Power Amplifier
PCB [1]	600-01711-00 Evaluation PCB

[1] Circuit Board Material: Rogers 4350 or Arlon FR4

The circuit board used in the application should use RF circuit design techniques. Signal lines should have 50 Ohm impedance while the package ground leads and exposed paddle should be connected directly to the ground plane similar to that shown. A sufficient number of via holes should be used to connect the top and bottom ground planes. The evaluation board should be mounted to an appropriate heat sink. The evaluation circuit board shown is available from Analog Devices, Inc.

**GaAs pHEMT MMIC
1 WATT POWER AMPLIFIER, DC - 22 GHz**

Application Circuit

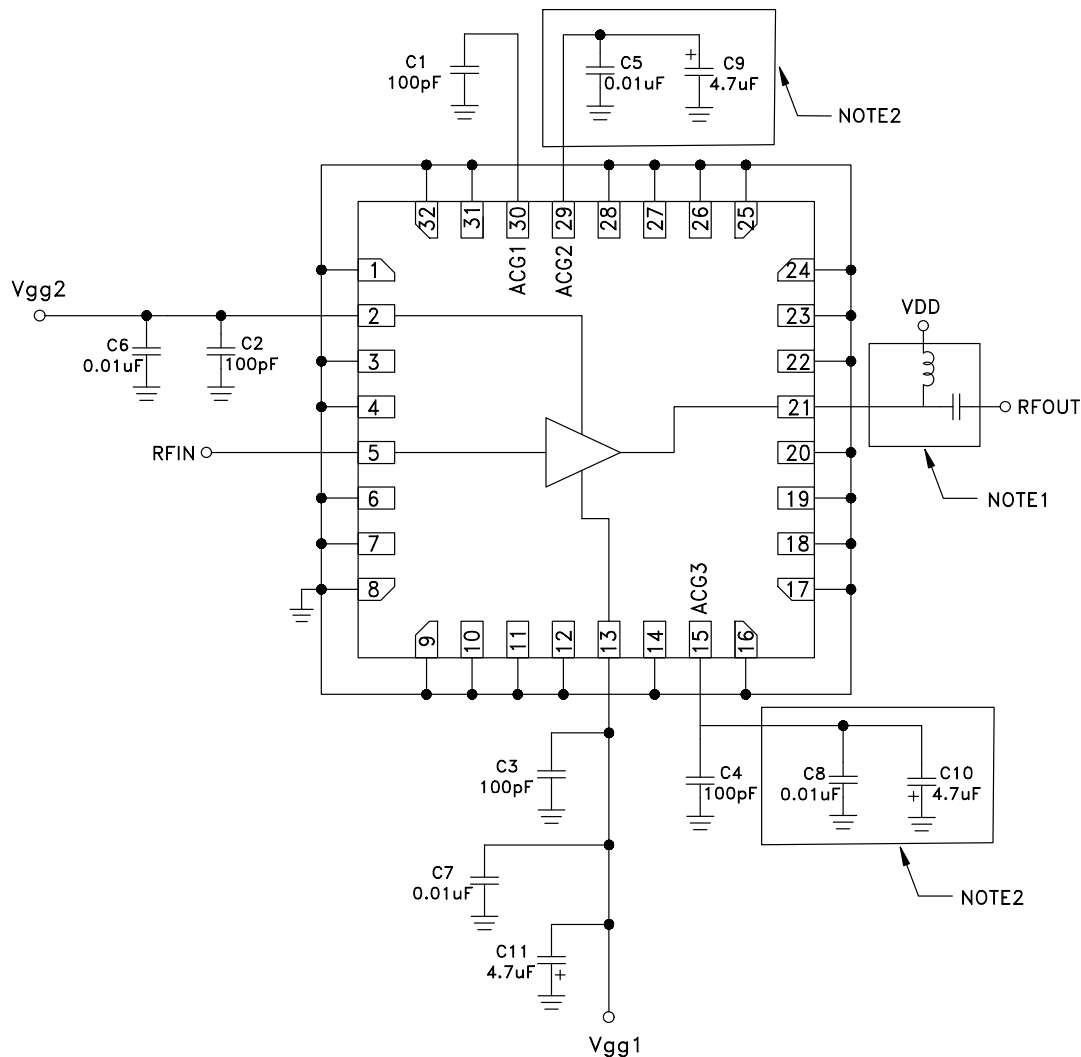

NOTE 1: Drain Bias (Vdd) must be applied through a broadband bias tee or external bias network.

NOTE 2: Optional Capacitors to be used if part is to be operated below 200MHz.