

---

## P-Channel Enhancement-Mode Vertical DMOS FET

---

### Features

- Low Threshold
- High Input Impedance
- Low Input Capacitance
- Fast Switching Speeds
- Free from Secondary Breakdown
- Low Input and Output Leakage

### Applications

- Logic-Level Interfaces (Ideal for TTL and CMOS)
- Solid-State Relays
- Linear Amplifiers
- Analog Switches
- Power Management
- Telecommunication Switches

### General Description

The TP2435 low-threshold Enhancement-mode (normally-off) transistor uses a vertical DMOS structure and a well-proven silicon gate manufacturing process. This combination produces a device with the power handling capabilities of bipolar transistors and the high input impedance and positive temperature coefficient inherent in MOS devices. Characteristic of all MOS structures, this device is free from thermal runaway and thermally induced secondary breakdown.

Microchip's vertical DMOS FETs are ideally suited to a wide range of switching and amplifying applications where very low threshold voltage, high breakdown voltage, high input impedance, low input capacitance, and fast switching speeds are desired.

### Package Type

**3-lead SOT-89**  
(Top view)

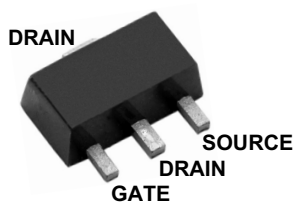

See [Table 3-1](#) for pin information.

# TP2435

## 1.0 ELECTRICAL CHARACTERISTICS

### Absolute Maximum Ratings†

|  |                                   |
|--|-----------------------------------|
| Drain-to-Source Voltage .....              | $BV_{DSS}$                        |
| Drain-to-Gate Voltage .....                | $BV_{DGS}$                        |
| Gate-to-Source Voltage .....               | $\pm 20V$                         |
| Operating Ambient Temperature, $T_A$ ..... | $-55^{\circ}C$ to $+150^{\circ}C$ |
| Storage Temperature, $T_S$ .....           | $-55^{\circ}C$ to $+150^{\circ}C$ |

† **Notice:** Stresses above those listed under “Absolute Maximum Ratings” may cause permanent damage to the device. This is a stress rating only, and functional operation of the device at those or any other conditions above those indicated in the operational sections of this specification is not intended. Exposure to maximum rating conditions for extended periods may affect device reliability.

### DC ELECTRICAL CHARACTERISTICS

**Electrical Specifications:**  $T_A = 25^{\circ}C$  unless otherwise specified. All DC parameters are 100% tested at  $25^{\circ}C$  unless otherwise stated. Pulse test: 300  $\mu s$  pulse, 2% duty cycle

| Parameter                                  | Sym.                | Min. | Typ. | Max. | Unit            | Conditions   |
|--|---------------------|------|------|------|-----------------|--|
| Drain-to-Source Breakdown Voltage          | $BV_{DSS}$          | -350 | —    | —    | V               | $V_{GS} = 0V, I_D = -250 \mu A$  |
| Gate Threshold Voltage                     | $V_{GS(th)}$        | -1   | —    | -2.4 | V               | $V_{GS} = V_{DS}, I_D = -1 mA$   |
| Change in $V_{GS(th)}$ with Temperature    | $\Delta V_{GS(th)}$ | —    | —    | 4.5  | mV/ $^{\circ}C$ | $V_{GS} = V_{DS}, I_D = -1 mA$<br>( <b>Note 1</b> )  |
| Gate Body Leakage Current                  | $I_{GSS}$           | —    | —    | -100 | nA              | $V_{GS} = \pm 20V, V_{DS} = 0V$  |
| Zero-Gate Voltage Drain Current            | $I_{DSS}$           | —    | —    | -10  | $\mu A$         | $V_{GS} = 0V,$<br>$V_{DS} = \text{Maximum rating}$   |
|  |                     | —    | —    | -1   | mA              | $V_{DS} = 0.8 \text{ Maximum rating},$<br>$V_{GS} = 0V, T_A = 125^{\circ}C$<br>( <b>Note 1</b> ) |
| On-State Drain Current                     | $I_{D(ON)}$         | -0.3 | —    | —    | A               | $V_{GS} = -4.5V, V_{DS} = -25V$  |
|  |                     | -0.8 | —    | —    | A               | $V_{GS} = -10V, V_{DS} = -25V$   |
| Static Drain-to-Source On-State Resistance | $R_{DS(ON)}$        | —    | —    | 15   | $\Omega$        | $V_{GS} = -3V, I_D = -20 mA$   |
|  |                     | —    | —    | 15   | $\Omega$        | $V_{GS} = -4.5V, I_D = -150 mA$  |
|  |                     | —    | —    | 15   | $\Omega$        | $V_{GS} = -10V, I_D = -500 mA$   |
| Change in $R_{DS(ON)}$ with Temperature    | $\Delta R_{DS(ON)}$ | —    | —    | 1.7  | %/ $^{\circ}C$  | $V_{GS} = -10V, I_D = -150 mA$<br>( <b>Note 1</b> )  |

**Note 1:** Specification is obtained by characterization and is not 100% tested.

## AC ELECTRICAL CHARACTERISTICS

**Electrical Specifications:**  $T_A = 25^\circ\text{C}$  unless otherwise specified. Specification is obtained by characterization and is not 100% tested.

| Parameter                        | Sym.         | Min. | Typ. | Max. | Unit | Conditions   |
|----------------------------------|--------------|------|------|------|------|--|
| Forward Transconductance         | $G_{FS}$     | 125  | —    | —    | mmho | $V_{DS} = -25\text{V}$ , $I_D = -350\text{ mA}$                              |
| Input Capacitance                | $C_{ISS}$    | —    | —    | 200  | pF   | $V_{GS} = 0\text{V}$ ,<br>$V_{DS} = -25\text{V}$ ,<br>$f = 1\text{ MHz}$     |
| Common Source Output Capacitance | $C_{OSS}$    | —    | —    | 70   | pF   |  |
| Reverse Transfer Capacitance     | $C_{RSS}$    | —    | —    | 25   | pF   |  |
| Turn-On Delay Time               | $t_{d(ON)}$  | —    | —    | 15   | ns   | $V_{DD} = -25\text{V}$ ,<br>$I_D = -250\text{ mA}$ ,<br>$R_{GEN} = 25\Omega$ |
| Rise Time                        | $t_r$        | —    | —    | 20   | ns   |  |
| Turn-Off Delay Time              | $t_{d(OFF)}$ | —    | —    | 25   | ns   |  |
| Fall Time                        | $t_f$        | —    | —    | 50   | ns   |  |

### DIODE PARAMETER

|                            |          |   |     |      |    |   |
|----------------------------|----------|---|-----|------|----|---|
| Diode Forward Voltage Drop | $V_{SD}$ | — | —   | -1.5 | V  | $V_{GS} = 0\text{V}$ , $I_{SD} = -750\text{ mA}$ (Note 1) |
| Reverse Recovery Time      | $t_{rr}$ | — | 300 | —    | ns | $V_{GS} = 0\text{V}$ , $I_{SD} = -750\text{ mA}$          |

**Note 1:** Unless otherwise stated, all DC parameters are 100% tested at  $25^\circ\text{C}$ . Pulse test: 300  $\mu\text{s}$  pulse, 2% duty cycle

## TEMPERATURE SPECIFICATIONS

| Parameter                         | Sym.          | Min. | Typ. | Max. | Unit               | Conditions |
|-----------------------------------|---------------|------|------|------|--------------------|------------|
| <b>TEMPERATURE RANGE</b>          |               |      |      |      |                    |            |
| Operating Ambient Temperature     | $T_A$         | -55  | —    | +150 | $^\circ\text{C}$   |            |
| Storage Temperature               | $T_S$         | -55  | —    | +150 | $^\circ\text{C}$   |            |
| <b>PACKAGE THERMAL RESISTANCE</b> |               |      |      |      |                    |            |
| 3-lead SOT-89                     | $\theta_{JA}$ | —    | 133  | —    | $^\circ\text{C/W}$ | Note 1     |

**Note 1:** Mounted on an FR5 board, 25 mm x 25 mm x 1.57 mm

## THERMAL CHARACTERISTICS

| Package       | $I_D$ (Note 1)<br>(Continuous)<br>(mA) | $I_D$<br>(Pulsed)<br>(A) | Power Dissipation<br>at $T_A = 25^\circ\text{C}$<br>(Note 2)<br>(W) | $I_{DR}$ (Note 1)<br>(mA) | $I_{DRM}$<br>(A) |
|---------------|--|--------------------------|---|---------------------------|------------------|
| 3-lead SOT-89 | -231                                   | -1.1                     | 1.6   | -231                      | -1.1             |

**Note 1:**  $I_D$  (continuous) is limited by maximum rated  $T_J$ .

**2:** Mounted on an FR5 board, 25 mm x 25 mm x 1.57 mm

## 2.0 TYPICAL PERFORMANCE CURVES

**Note:** The graphs and tables provided following this note are a statistical summary based on a limited number of samples and are provided for informational purposes only. The performance characteristics listed herein are not tested or guaranteed. In some graphs or tables, the data presented may be outside the specified operating range (e.g. outside specified power supply range) and therefore outside the warranted range.

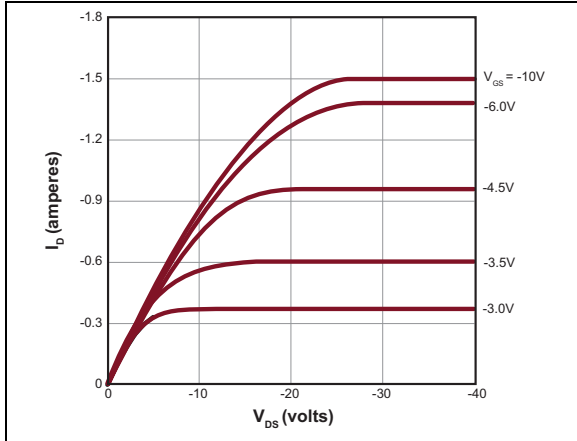

**FIGURE 2-1:** Output Characteristics.

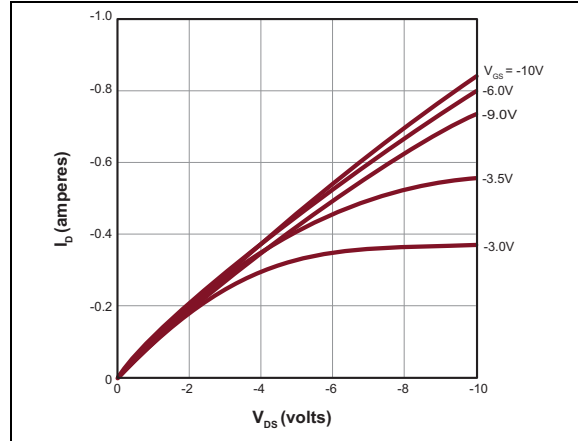

**FIGURE 2-4:** Saturation Characteristics.

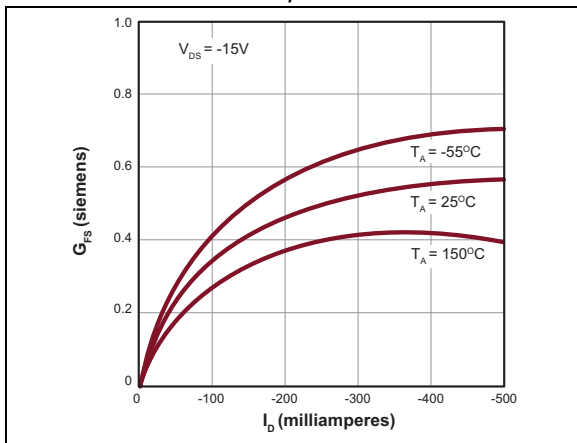

**FIGURE 2-2:** Transconductance vs. Drain Current.

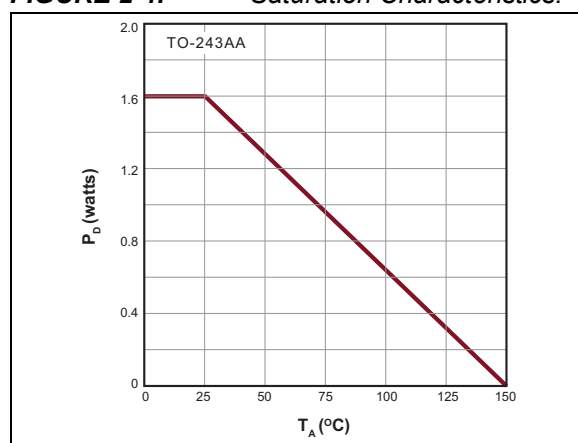

**FIGURE 2-5:** Power Dissipation vs. Ambient Temperature.

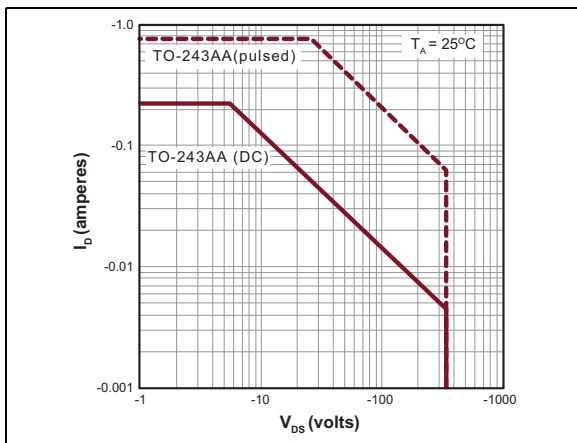

**FIGURE 2-3:** Maximum Rated Safe Operating Area.

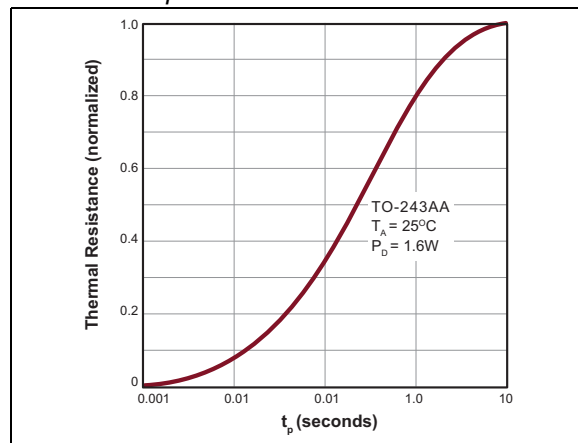

**FIGURE 2-6:** Thermal Response Characteristics.

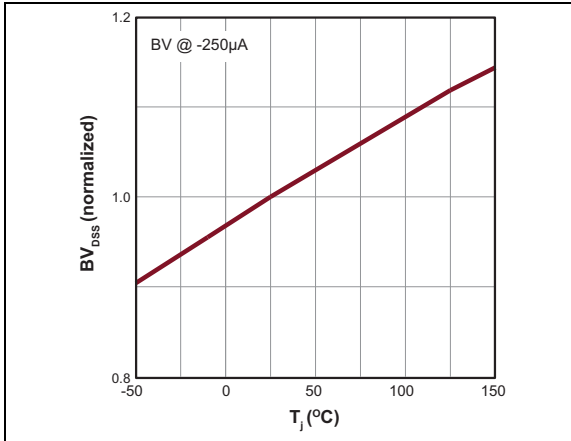

**FIGURE 2-7:**  $BV_{DSS}$  Variation with Temperature.

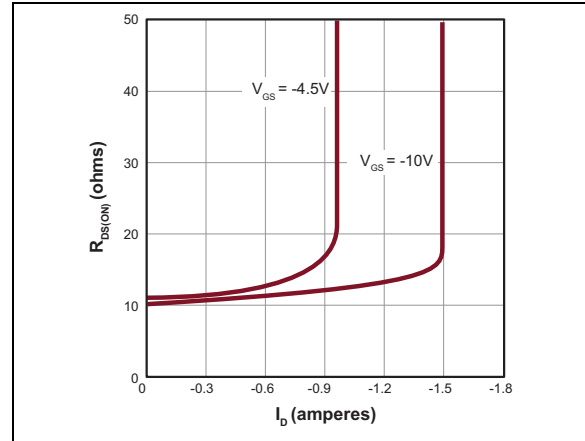

**FIGURE 2-10:** On-Resistance vs. Drain Current.

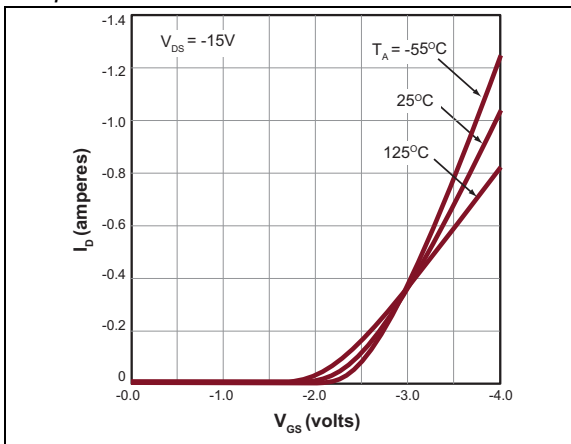

**FIGURE 2-8:** Transfer Characteristics.

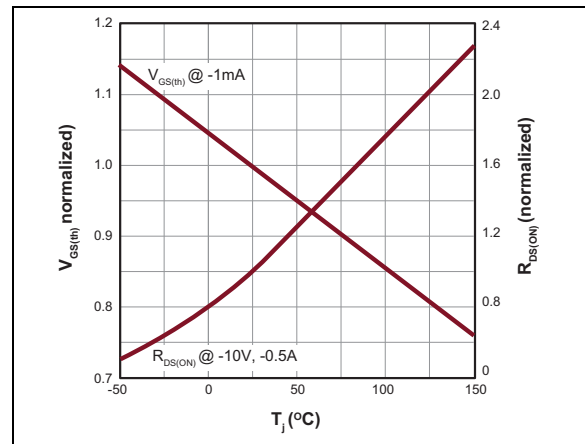

**FIGURE 2-11:**  $V_{GS(th)}$  and  $R_{DS}$  Variation with Temperature.

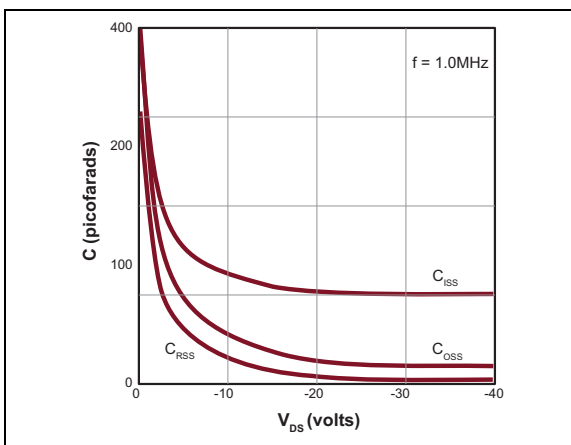

**FIGURE 2-9:** Capacitance vs. Drain-to-Source Voltage.

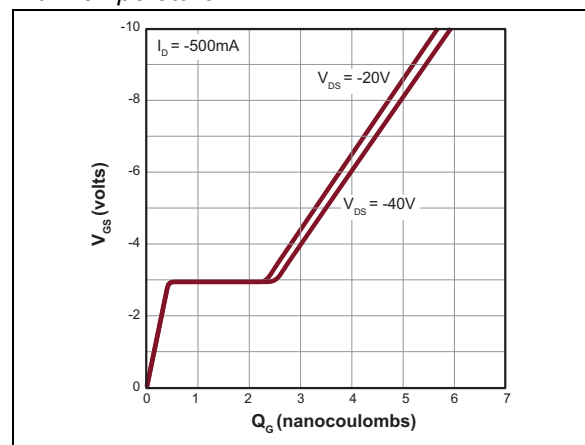

**FIGURE 2-12:** Gate Drive Dynamic Characteristics.

# TP2435

---

## 3.0 PIN DESCRIPTION

The details on the pins of TP2435 are listed in [Table 3-1](#). Refer to [Package Type](#) for the location of pins.

**TABLE 3-1: PIN FUNCTION TABLE**

| Pin Number | Pin Name | Description |
|------------|----------|-------------|
| 1          | Gate     | Gate        |
| 2, 4       | Drain    | Drain       |
| 3          | Source   | Source      |

## 4.0 FUNCTIONAL DESCRIPTION

Figure 4-1 illustrates the switching waveforms and test circuit for TP2435.

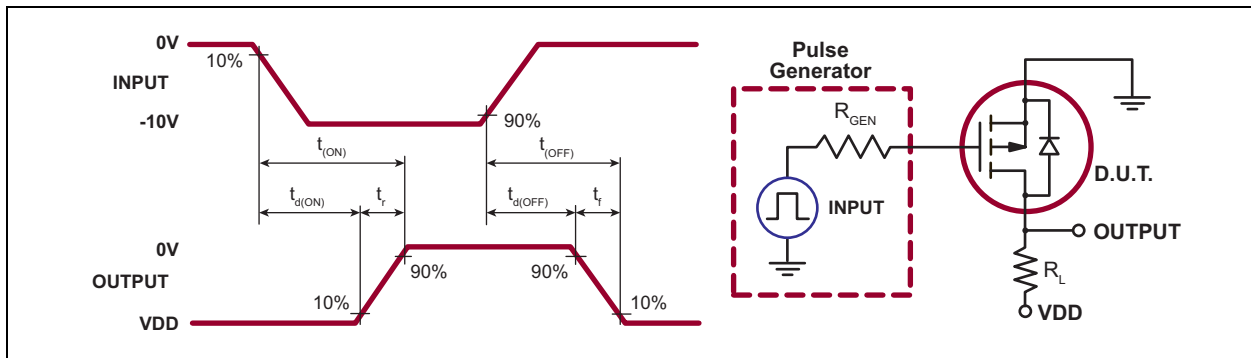

**FIGURE 4-1:** Switching Waveforms and Test Circuit.

**TABLE 4-1: PRODUCT SUMMARY**

| $BV_{DSS}/BV_{DGS}$<br>(V) | $R_{DS(ON)}$<br>(Maximum)<br>( $\Omega$ ) | $V_{GS(TH)}$<br>(Maximum)<br>(V) | $I_{D(ON)}$<br>(Minimum)<br>(mA) |
|----------------------------|---|----------------------------------|----------------------------------|
| -350                       | 15  | -2.4                             | -800                             |

# TP2435

---

## 5.0 PACKAGING INFORMATION

### 5.1 Package Marking Information

3-lead SOT-89

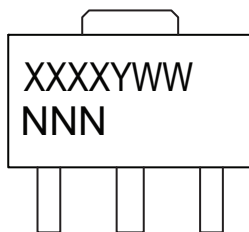

Example

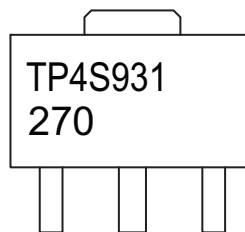

|                |  |  |
|----------------|--|--|
| <b>Legend:</b> | XX...X   | Product Code or Customer-specific information  |
|                | Y  | Year code (last digit of calendar year)  |
|                | YY   | Year code (last 2 digits of calendar year)   |
|                | WW   | Week code (week of January 1 is week '01')   |
|                | NNN  | Alphanumeric traceability code   |
|                | (e3)   | Pb-free JEDEC® designator for Matte Tin (Sn)   |
|                | *  | This package is Pb-free. The Pb-free JEDEC designator (e3) can be found on the outer packaging for this package. |
| <b>Note:</b>   | In the event the full Microchip part number cannot be marked on one line, it will be carried over to the next line, thus limiting the number of available characters for product code or customer-specific information. Package may or not include the corporate logo. |  |



## 3-Lead TO-243AA (SOT-89) Package Outline (N8)

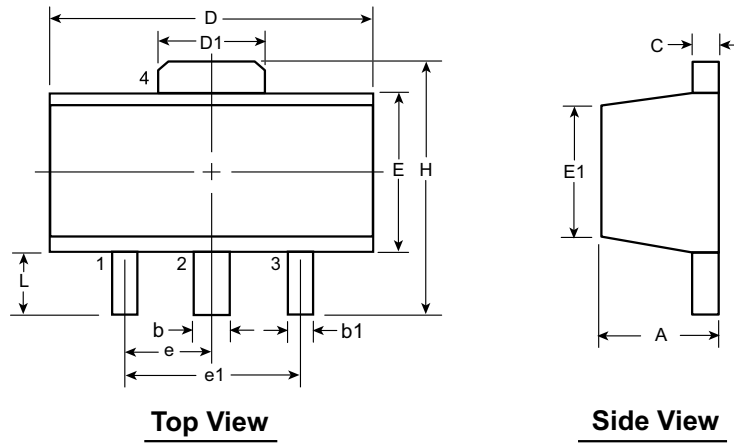

Note: For the most current package drawings, see the Microchip Packaging Specification at [www.microchip.com/packaging](http://www.microchip.com/packaging).

| Symbol             | A   | b    | b1   | C    | D    | D1   | E    | E1   | e                 | e1          | H           | L    |                   |   |
|--------------------|-----|------|------|------|------|------|------|------|-------------------|-------------|-------------|------|-------------------|---|
| Dimensions<br>(mm) | MIN | 1.40 | 0.44 | 0.36 | 0.35 | 4.40 | 1.62 | 2.29 | 2.00 <sup>†</sup> | 1.50<br>BSC | 3.00<br>BSC | 3.94 | 0.73 <sup>†</sup> |   |
|                    | NOM | -    | -    | -    | -    | -    | -    | -    | -                 |             |             | -    | -                 | - |
|                    | MAX | 1.60 | 0.56 | 0.48 | 0.44 | 4.60 | 1.83 | 2.60 | 2.29              |             |             | 4.25 | 1.20              |   |

JEDEC Registration TO-243, Variation AA, Issue C, July 1986.

<sup>†</sup> This dimension differs from the JEDEC drawing

Drawings not to scale.

# TP2435

---

NOTES:

## APPENDIX A: REVISION HISTORY

### Revision A (October 2019)

- Converted Supertex Doc# DSFP-TP2435 to Microchip DS20005961A
- Added a pin function table
- Changed the package marking format
- Made minor text changes throughout the document

# TP2435

## PRODUCT IDENTIFICATION SYSTEM

To order or obtain information, e.g., on pricing or delivery, contact your local Microchip representative or sales office.

| <u>PART NO.</u> | <u>XX</u>       | - | <u>X</u>                                     | - | <u>X</u>   |
|-----------------|-----------------|---|--|---|------------|
| Device          | Package Options |   | Environmental                                |   | Media Type |
| Device:         | TP2435          | = | P-Channel Enhancement-Mode Vertical DMOS FET |   |            |
| Package:        | N8              | = | 3-lead SOT-89                                |   |            |
| Environmental:  | G               | = | Lead (Pb)-free/RoHS-compliant Package        |   |            |
| Media Type:     | (blank)         | = | 2000/Reel for an N8 Package                  |   |            |

**Example:**

a) TP2435N8-G: P-Channel Enhancement-Mode, Vertical DMOS FET, 3-lead SOT-89, 2000/Reel

---

**Note the following details of the code protection feature on Microchip devices:**

- Microchip products meet the specification contained in their particular Microchip Data Sheet.
- Microchip believes that its family of products is one of the most secure families of its kind on the market today, when used in the intended manner and under normal conditions.
- There are dishonest and possibly illegal methods used to breach the code protection feature. All of these methods, to our knowledge, require using the Microchip products in a manner outside the operating specifications contained in Microchip's Data Sheets. Most likely, the person doing so is engaged in theft of intellectual property.
- Microchip is willing to work with the customer who is concerned about the integrity of their code.
- Neither Microchip nor any other semiconductor manufacturer can guarantee the security of their code. Code protection does not mean that we are guaranteeing the product as “unbreakable.”

Code protection is constantly evolving. We at Microchip are committed to continuously improving the code protection features of our products. Attempts to break Microchip's code protection feature may be a violation of the Digital Millennium Copyright Act. If such acts allow unauthorized access to your software or other copyrighted work, you may have a right to sue for relief under that Act.

---

Information contained in this publication regarding device applications and the like is provided only for your convenience and may be superseded by updates. It is your responsibility to ensure that your application meets with your specifications. MICROCHIP MAKES NO REPRESENTATIONS OR WARRANTIES OF ANY KIND WHETHER EXPRESS OR IMPLIED, WRITTEN OR ORAL, STATUTORY OR OTHERWISE, RELATED TO THE INFORMATION, INCLUDING BUT NOT LIMITED TO ITS CONDITION, QUALITY, PERFORMANCE, MERCHANTABILITY OR FITNESS FOR PURPOSE. Microchip disclaims all liability arising from this information and its use. Use of Microchip devices in life support and/or safety applications is entirely at the buyer's risk, and the buyer agrees to defend, indemnify and hold harmless Microchip from any and all damages, claims, suits, or expenses resulting from such use. No licenses are conveyed, implicitly or otherwise, under any Microchip intellectual property rights unless otherwise stated.

### Trademarks

The Microchip name and logo, the Microchip logo, Adaptec, AnyRate, AVR, AVR logo, AVR Freaks, BesTime, BitCloud, chipKIT, chipKIT logo, CryptoMemory, CryptoRF, dsPIC, FlashFlex, flexPWR, HELDO, IGLOO, JukeBlox, KeeLoq, Klear, LANCheck, LinkMD, maXStylus, maXTouch, MediaLB, megaAVR, Microsemi, Microsemi logo, MOST, MOST logo, MPLAB, OptoLyzer, PackeTime, PIC, picoPower, PICSTART, PIC32 logo, PolarFire, Prochip Designer, QTouch, SAM-BA, SenGenuity, SpyNIC, SST, SST Logo, SuperFlash, Symmetricom, SyncServer, Tachyon, TempTrackr, TimeSource, tinyAVR, UNI/O, Vectron, and XMEGA are registered trademarks of Microchip Technology Incorporated in the U.S.A. and other countries.

APT, ClockWorks, The Embedded Control Solutions Company, EtherSynch, FlashTec, Hyper Speed Control, HyperLight Load, IntelliMOS, Libero, motorBench, mTouch, Powermite 3, Precision Edge, ProASIC, ProASIC Plus, ProASIC Plus logo, Quiet-Wire, SmartFusion, SyncWorld, Temux, TimeCesium, TimeHub, TimePictra, TimeProvider, Vite, WinPath, and ZL are registered trademarks of Microchip Technology Incorporated in the U.S.A.

Adjacent Key Suppression, AKS, Analog-for-the-Digital Age, Any Capacitor, AnyIn, AnyOut, BlueSky, BodyCom, CodeGuard, CryptoAuthentication, CryptoAutomotive, CryptoCompanion, CryptoController, dsPICDEM, dsPICDEM.net, Dynamic Average Matching, DAM, ECAN, EtherGREEN, In-Circuit Serial Programming, ICSP, INICnet, Inter-Chip Connectivity, JitterBlocker, KlearNet, KlearNet logo, memBrain, Mindi, MiWi, MPASM, MPF, MPLAB Certified logo, MPLIB, MPLINK, MultiTRAK, NetDetach, Omniscient Code Generation, PICDEM, PICDEM.net, PICkit, PICtail, PowerSmart, PureSilicon, QMatrix, REAL ICE, Ripple Blocker, SAM-ICE, Serial Quad I/O, SMART-I.S., SQL, SuperSwitcher, SuperSwitcher II, Total Endurance, TSHARC, USBCheck, VariSense, ViewSpan, WiperLock, Wireless DNA, and ZENA are trademarks of Microchip Technology Incorporated in the U.S.A. and other countries.

SQTP is a service mark of Microchip Technology Incorporated in the U.S.A.

The Adaptec logo, Frequency on Demand, Silicon Storage Technology, and Symmcom are registered trademarks of Microchip Technology Inc. in other countries.

GestIC is a registered trademark of Microchip Technology Germany II GmbH & Co. KG, a subsidiary of Microchip Technology Inc., in other countries.

All other trademarks mentioned herein are property of their respective companies.

© 2019, Microchip Technology Incorporated, All Rights Reserved.

ISBN: 978-1-5224-5179-2

For information regarding Microchip's Quality Management Systems, please visit [www.microchip.com/quality](http://www.microchip.com/quality).



# MICROCHIP

## Worldwide Sales and Service

### AMERICAS

**Corporate Office**  
2355 West Chandler Blvd.  
Chandler, AZ 85224-6199  
Tel: 480-792-7200  
Fax: 480-792-7277  
Technical Support:  
<http://www.microchip.com/support>  
Web Address:  
[www.microchip.com](http://www.microchip.com)

**Atlanta**  
Duluth, GA  
Tel: 678-957-9614  
Fax: 678-957-1455

**Austin, TX**  
Tel: 512-257-3370

**Boston**  
Westborough, MA  
Tel: 774-760-0087  
Fax: 774-760-0088

**Chicago**  
Itasca, IL  
Tel: 630-285-0071  
Fax: 630-285-0075

**Dallas**  
Addison, TX  
Tel: 972-818-7423  
Fax: 972-818-2924

**Detroit**  
Novi, MI  
Tel: 248-848-4000

**Houston, TX**  
Tel: 281-894-5983

**Indianapolis**  
Noblesville, IN  
Tel: 317-773-8323  
Fax: 317-773-5453  
Tel: 317-536-2380

**Los Angeles**  
Mission Viejo, CA  
Tel: 949-462-9523  
Fax: 949-462-9608  
Tel: 951-273-7800

**Raleigh, NC**  
Tel: 919-844-7510

**New York, NY**  
Tel: 631-435-6000

**San Jose, CA**  
Tel: 408-735-9110  
Tel: 408-436-4270

**Canada - Toronto**  
Tel: 905-695-1980  
Fax: 905-695-2078

### ASIA/PACIFIC

**Australia - Sydney**  
Tel: 61-2-9868-6733

**China - Beijing**  
Tel: 86-10-8569-7000

**China - Chengdu**  
Tel: 86-28-8665-5511

**China - Chongqing**  
Tel: 86-23-8980-9588

**China - Dongguan**  
Tel: 86-769-8702-9880

**China - Guangzhou**  
Tel: 86-20-8755-8029

**China - Hangzhou**  
Tel: 86-571-8792-8115

**China - Hong Kong SAR**  
Tel: 852-2943-5100

**China - Nanjing**  
Tel: 86-25-8473-2460

**China - Qingdao**  
Tel: 86-532-8502-7355

**China - Shanghai**  
Tel: 86-21-3326-8000

**China - Shenyang**  
Tel: 86-24-2334-2829

**China - Shenzhen**  
Tel: 86-755-8864-2200

**China - Suzhou**  
Tel: 86-186-6233-1526

**China - Wuhan**  
Tel: 86-27-5980-5300

**China - Xian**  
Tel: 86-29-8833-7252

**China - Xiamen**  
Tel: 86-592-2388138

**China - Zhuhai**  
Tel: 86-756-3210040

### ASIA/PACIFIC

**India - Bangalore**  
Tel: 91-80-3090-4444

**India - New Delhi**  
Tel: 91-11-4160-8631

**India - Pune**  
Tel: 91-20-4121-0141

**Japan - Osaka**  
Tel: 81-6-6152-7160

**Japan - Tokyo**  
Tel: 81-3-6880-3770

**Korea - Daegu**  
Tel: 82-53-744-4301

**Korea - Seoul**  
Tel: 82-2-554-7200

**Malaysia - Kuala Lumpur**  
Tel: 60-3-7651-7906

**Malaysia - Penang**  
Tel: 60-4-227-8870

**Philippines - Manila**  
Tel: 63-2-634-9065

**Singapore**  
Tel: 65-6334-8870

**Taiwan - Hsin Chu**  
Tel: 886-3-577-8366

**Taiwan - Kaohsiung**  
Tel: 886-7-213-7830

**Taiwan - Taipei**  
Tel: 886-2-2508-8600

**Thailand - Bangkok**  
Tel: 66-2-694-1351

**Vietnam - Ho Chi Minh**  
Tel: 84-28-5448-2100

### EUROPE

**Austria - Wels**  
Tel: 43-7242-2244-39  
Fax: 43-7242-2244-393

**Denmark - Copenhagen**  
Tel: 45-4450-2828  
Fax: 45-4485-2829

**Finland - Espoo**  
Tel: 358-9-4520-820

**France - Paris**  
Tel: 33-1-69-53-63-20  
Fax: 33-1-69-30-90-79

**Germany - Garching**  
Tel: 49-8931-9700

**Germany - Haan**  
Tel: 49-2129-3766400

**Germany - Heilbronn**  
Tel: 49-7131-72400

**Germany - Karlsruhe**  
Tel: 49-721-625370

**Germany - Munich**  
Tel: 49-89-627-144-0  
Fax: 49-89-627-144-44

**Germany - Rosenheim**  
Tel: 49-8031-354-560

**Israel - Ra'anana**  
Tel: 972-9-744-7705

**Italy - Milan**  
Tel: 39-0331-742611  
Fax: 39-0331-466781

**Italy - Padova**  
Tel: 39-049-7625286

**Netherlands - Drunen**  
Tel: 31-416-690399  
Fax: 31-416-690340

**Norway - Trondheim**  
Tel: 47-7288-4388

**Poland - Warsaw**  
Tel: 48-22-3325737

**Romania - Bucharest**  
Tel: 40-21-407-87-50

**Spain - Madrid**  
Tel: 34-91-708-08-90  
Fax: 34-91-708-08-91

**Sweden - Gothenberg**  
Tel: 46-31-704-60-40

**Sweden - Stockholm**  
Tel: 46-8-5090-4654

**UK - Wokingham**  
Tel: 44-118-921-5800  
Fax: 44-118-921-5820