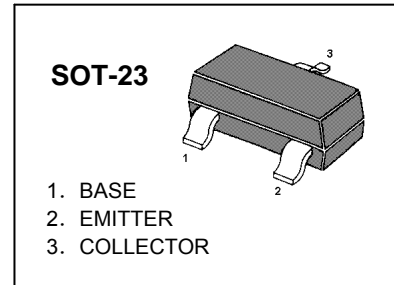

**SS8050 TRANSISTOR (NPN)**
**FEATURES**

Complimentary to SS8550

**MARKING: Y1**

**MAXIMUM RATINGS (T<sub>A</sub>=25°C unless otherwise noted)**

Symbol	Parameter	Value	Units
V <sub>CB0</sub>	Collector-Base Voltage	40	V
V <sub>CEO</sub>	Collector-Emitter Voltage	25	V
V <sub>EBO</sub>	Emitter-Base Voltage	5	V
I <sub>C</sub>	Collector Current -Continuous	1.5	A
P <sub>C</sub>	Collector Power Dissipation	0.3	W
T <sub>j</sub>	Junction Temperature	150	°C
T <sub>stg</sub>	Storage Temperature	-55-150	°C

**ELECTRICAL CHARACTERISTICS (T<sub>amb</sub>=25°C unless otherwise specified)**

Parameter	Symbol	Test conditions	MIN	TYP	MAX	UNIT
Collector-base breakdown voltage	V <sub>(BR)CBO</sub>	I <sub>C</sub> = 100μA, I <sub>E</sub> =0	40			V
Collector-emitter breakdown voltage	V <sub>(BR)CEO</sub>	I <sub>C</sub> = 0.1mA, I <sub>B</sub> =0	25			V
Emitter-base breakdown voltage	V <sub>(BR)EBO</sub>	I <sub>E</sub> =100μA, I <sub>C</sub> =0	5			V
Collector cut-off current	I <sub>CBO</sub>	V <sub>CB</sub> =40V, I <sub>E</sub> =0			0.1	μA
Collector cut-off current	I <sub>CEO</sub>	V <sub>CB</sub> =20V, I <sub>E</sub> =0			0.1	μA
Emitter cut-off current	I <sub>EBO</sub>	V <sub>EB</sub> = 5V, I <sub>C</sub> =0			0.1	μA
DC current gain	h <sub>FE(1)</sub>	V <sub>CE</sub> =1V, I <sub>C</sub> = 100mA	200		350	
	h <sub>FE(2)</sub>	V <sub>CE</sub> =1V, I <sub>C</sub> = 800mA	40			
Collector-emitter saturation voltage	V <sub>CE(sat)</sub>	I <sub>C</sub> =800mA, I <sub>B</sub> = 80mA			0.5	V
Base-emitter saturation voltage	V <sub>BE(sat)</sub>	I <sub>C</sub> =800mA, I <sub>B</sub> = 80mA			1.2	V
Transition frequency	f <sub>T</sub>	V <sub>CE</sub> =10V, I <sub>C</sub> = 50mA f=30MHz	100			MHz

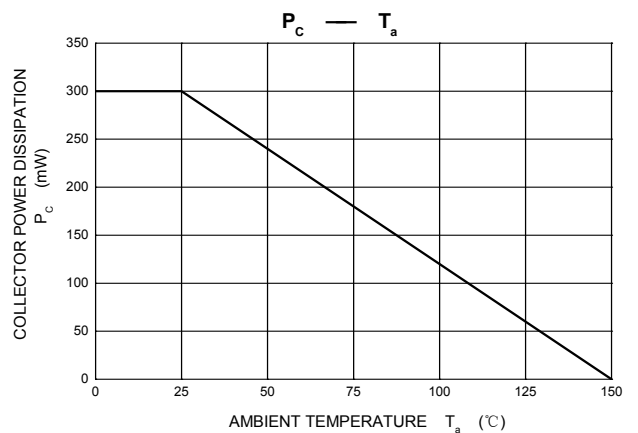
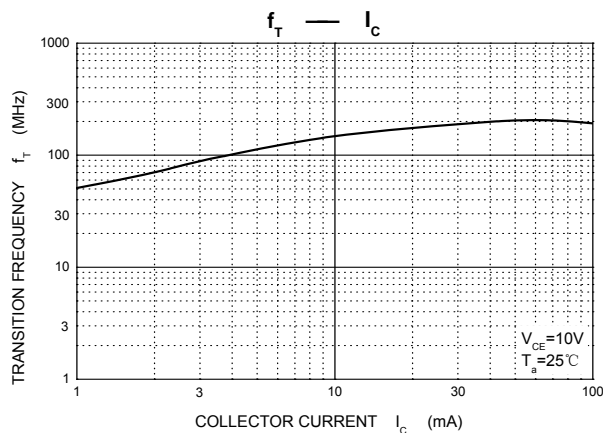
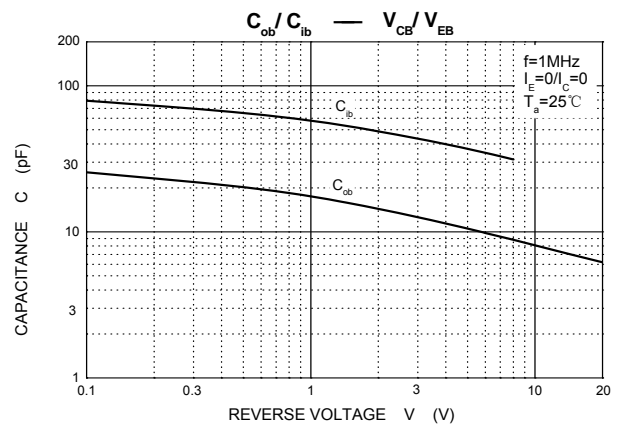
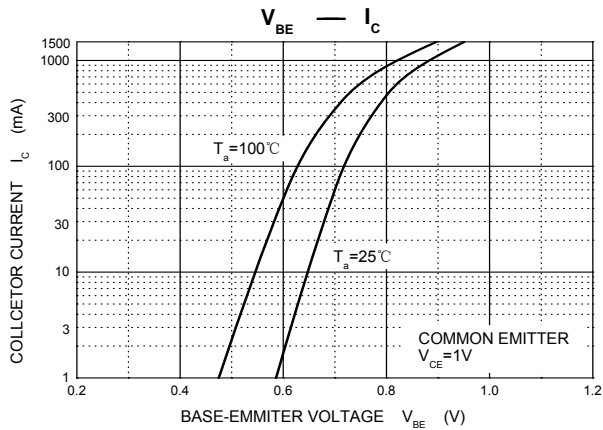
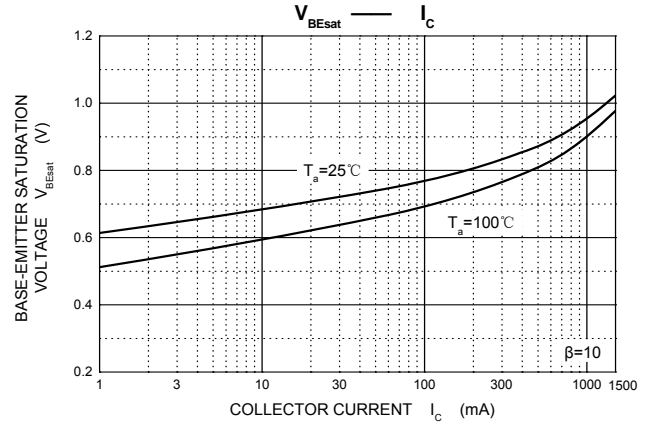
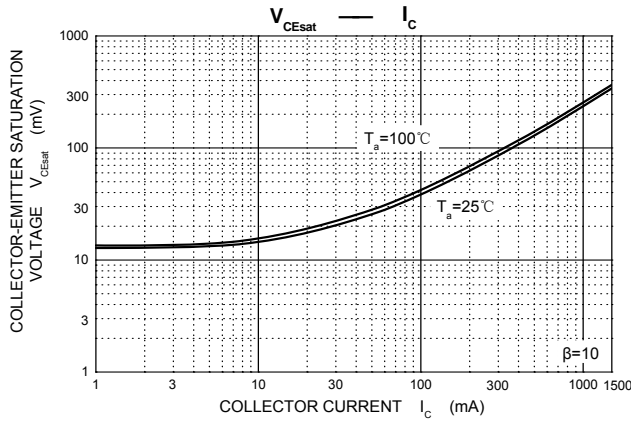
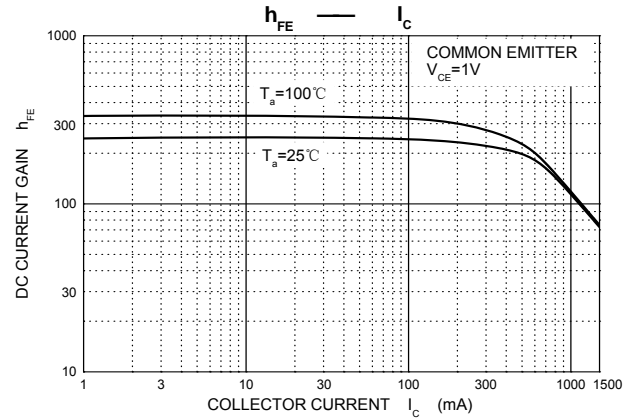
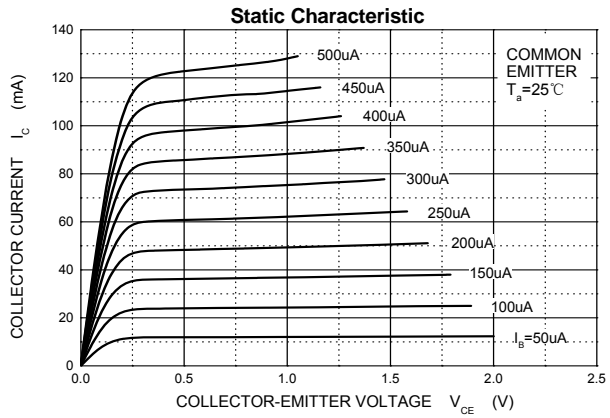
Typical Characteristics



PACKAGE OUTLINE

Plastic surface mounted package; 3 leads

SOT-23

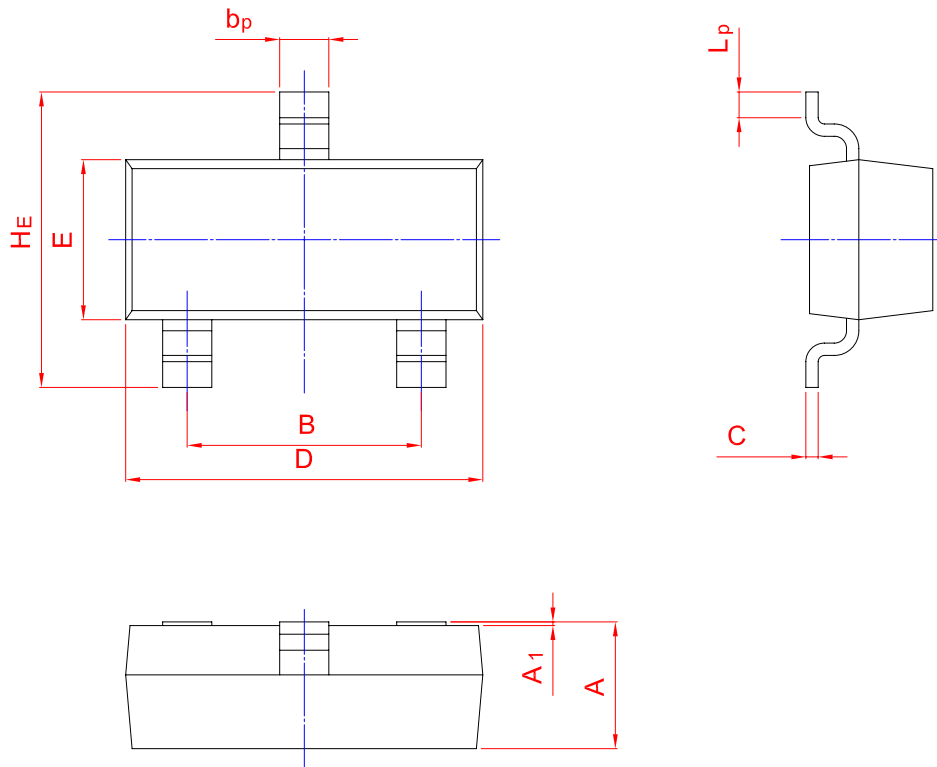

UNIT	A	B	bp	C	D	E	HE	A1	Lp
mm	1.40	2.04	0.50	0.19	3.10	1.65	3.00	0.100	0.50
	0.95	1.78	0.35	0.08	2.70	1.20	2.20	0.013	0.20