

N-Channel Enhancement Mode MOSFET

● Feature

30V/3.6A, $R_{DS(ON)} = 70\text{m}\Omega(\text{MAX}) @V_{GS} = 10\text{V}$.
 $R_{DS(ON)} = 100\text{m}\Omega(\text{MAX}) @V_{GS} = 4.5\text{V}$.

Super High dense cell design for extremely low $R_{DS(ON)}$.
 Reliable and Rugged.
 SOT-23 for Surface Mount Package.

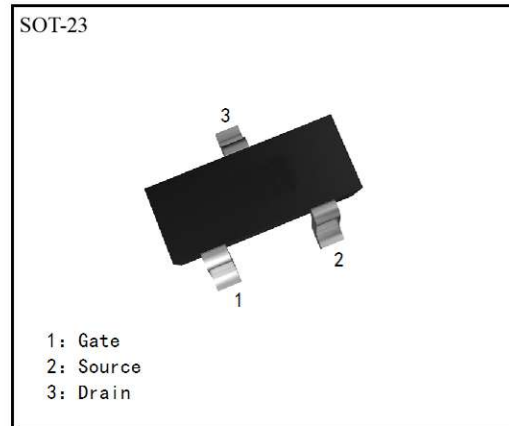

● Applications

Power Management
 Portable Equipment and Battery Powered Systems.

● Absolute Maximum Ratings TA=25°C Unless Otherwise noted

Parameter	Symbol	Limit	Units
Drain-Source Voltage	V_{DS}	30	V
Gate-Source Voltage	V_{GS}	± 20	V
Drain Current-Continuous	I_D	3.6	A

● Electrical Characteristics TA=25°C Unless Otherwise noted

Parameter	Symbol	Test Conditions	Min	Typ.	Max	Units
Off Characteristics						
Drain to Source Breakdown Voltage	BVDSS	$V_{GS}=0\text{V}, I_D=250\mu\text{A}$	30	-	-	V
Zero-Gate Voltage Drain Current	IDSS	$V_{DS}=30\text{V}, V_{GS}=0\text{V}$	-	-	1	μA
Gate Body Leakage Current, Forward	IGSSF	$V_{GS}=20\text{V}, V_{DS}=0\text{V}$	-	-	100	nA
Gate Body Leakage Current, Reverse	IGSSR	$V_{GS}=-20\text{V}, V_{DS}=0\text{V}$	-	-	-100	nA
On Characteristics						
Gate Threshold Voltage	$V_{GS(th)}$	$V_{GS}=V_{DS}, I_D=250\mu\text{A}$	1.1	-	2.2	V
Static Drain-source On-Resistance	$R_{DS(ON)}$	$V_{GS}=10\text{V}, I_D=3.6\text{A}$	-	50	70	$\text{m}\Omega$
		$V_{GS}=4.5\text{V}, I_D=3.1\text{A}$	-	80	100	$\text{m}\Omega$
Drain-Source Diode Characteristics and Maximum Ratings						
Drain-Source Diode Forward Voltage	VSD	$V_{GS}=0\text{V}, I_S=1.0\text{A}$			1.2	V



Dynamic					
Qg	Total Gate Charge	Vds=15V,Vgs=10V,Id=2A	8.5	12	nC
Qgs	Gate-Source Charge		1.1		
Qgd	Gate-Drain Charge		1.8		
ton	Turn-on Time	VDD=15V,Id=2A,Vgs=10V,RG=6Ω		40	ns
td(ON)	Turn-on Delay time		11		
tr	Turn-on Rise Time		17		
Td(off)	Turn-off Delay Time		37		
tf	Turn-off Fall Time		20		
toff	Turn-off Time			60	

Typical Characteristics

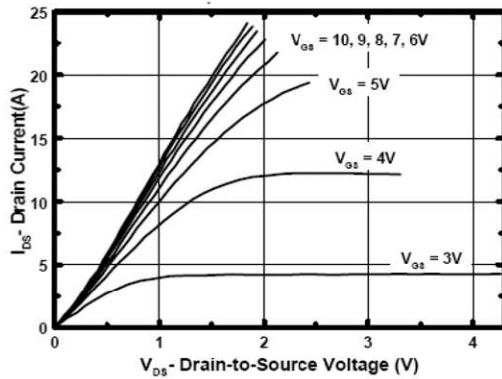

Figure 1. Output Characteristics

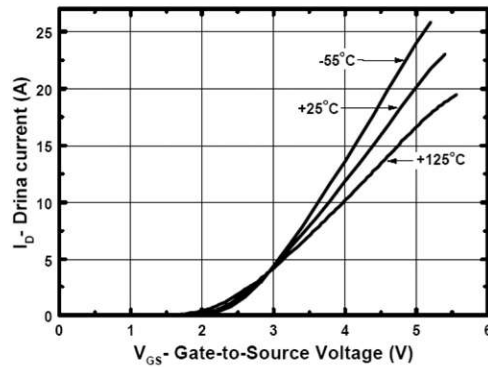

Figure 2. Transfer Characteristics

Typical Characteristics

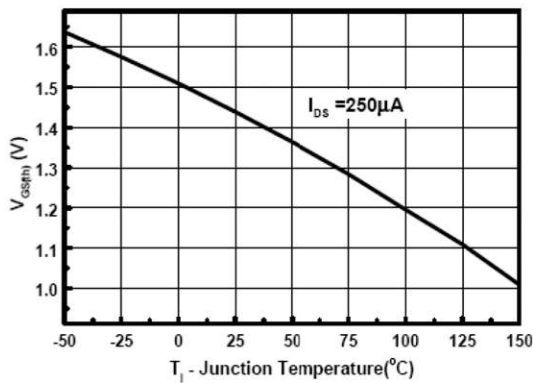

Figure 3. Gate Threshold Variation with Temperature

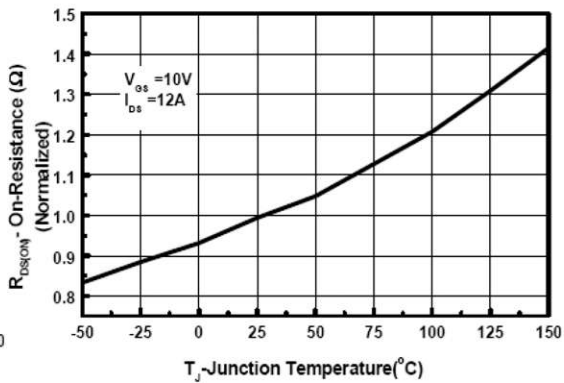

Figure 4. On-Resistance Variation with Temperature



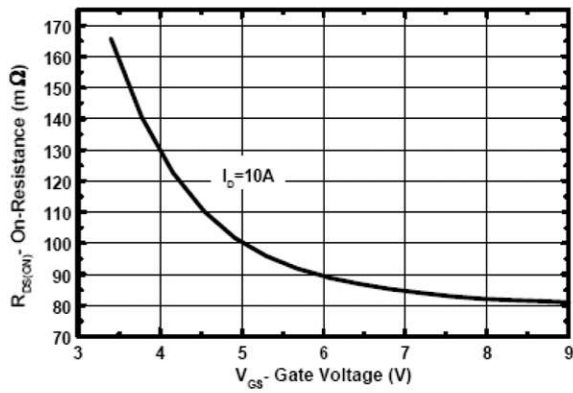

Figure 5. On-Resistance vs. Gate-to-Source Voltage

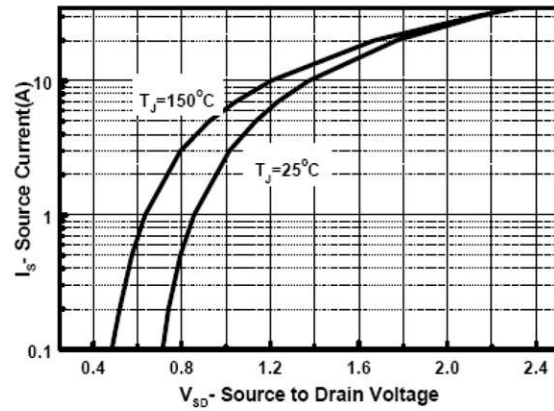

Figure 6. Source-Drain Diode Forward



Package Outline Dimensions (UNIT: mm)

SOT-23

