

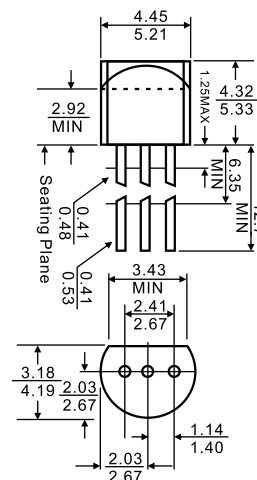

1. GND
2. IN
3. OUT

TO-92



Features

- ◇ Maximum Output current
 $I_{OM}: 0.1 \text{ A}$
- ◇ Output voltage
 $V_o: -5 \text{ V}$
- ◇ Continuous total dissipation
 $P_D: 0.625 \text{ W}$

ABSOLUTE MAXIMUM RATINGS (Operating temperature range applies unless otherwise specified)

Dimensions in inches and (millimeters)

Parameter	Symbol	Value	Units
Input Voltage	V_i	-30	V
Operating Junction Temperature Range	T_{OPR}	-30~+150	°C
Storage Temperature Range	T_{STG}	-55~+150	°C

ELECTRICAL CHARACTERISTICS ($V_i=-10V, I_o=40mA, C_i=0.33\mu F, C_o=0.1\mu F$, unless otherwise specified)

Parameter	Symbol	Test conditions	MIN	TYP	MAX	UNIT	
Output voltage	V_o	25°C	-4.8	-5.0	-5.2	V	
		0-125°C	$-7V \leq V_i \leq -20V, I_o=1mA \sim 40mA$	-4.75	-5.0	-5.25	V
			$I_o=1mA \sim 70mA$	-4.75	-5.0	-5.25	V
Load Regulation	ΔV_o	$I_o=1mA \sim 100mA$	25°C	20	60	mV	
		$I_o=1mA \sim 40mA$	25°C	10	30	mV	
Line regulation	ΔV_o	$-7V \leq V_i \leq -20V$	25°C	15	150	mV	
		$-8V \leq V_i \leq -20V$	25°C	12	100	mV	
Quiescent Current	I_q	25°C			6	mA	
Quiescent Current Change	ΔI_q	$-8V \leq V_i \leq -20V$	0-125°C		1.5	mA	
		$1mA \leq I_o \leq 40mA$	0-125°C		0.1	mA	
Output Noise Voltage	V_N	10Hz $\leq f \leq$ 100KHz	25°C	40		uV	
Ripple Rejection	RR	$-8V \leq V_i \leq -18V, f=120Hz$	0-125°C	41	49	dB	
Dropout Voltage	V_d	25°C		1.7		V	

TYPICAL APPLICATION

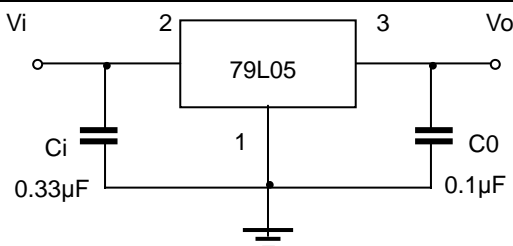

Note : Bypass capacitors are recommended for optimum stability and transient response and should be located as close as possible to the regulators.

Typical Characteristics

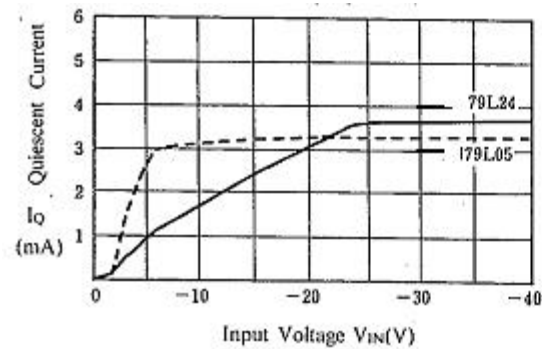
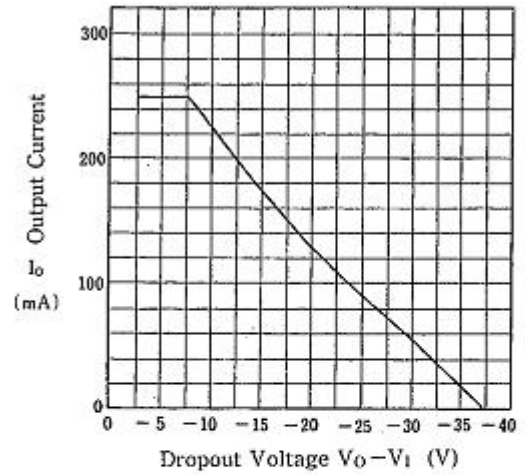
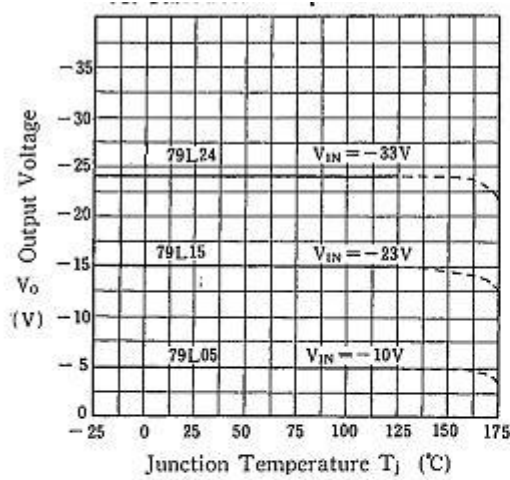
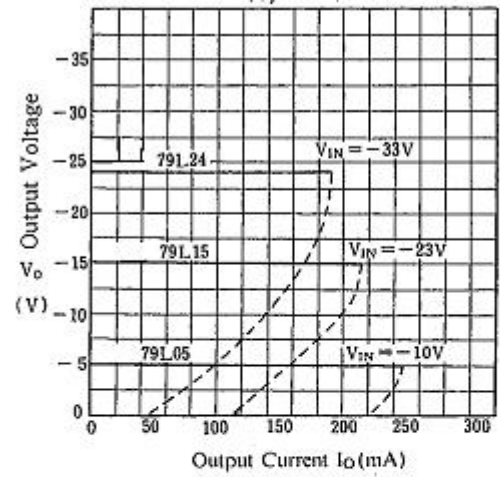
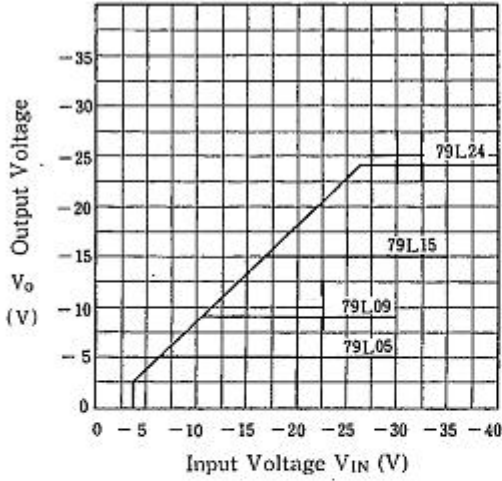

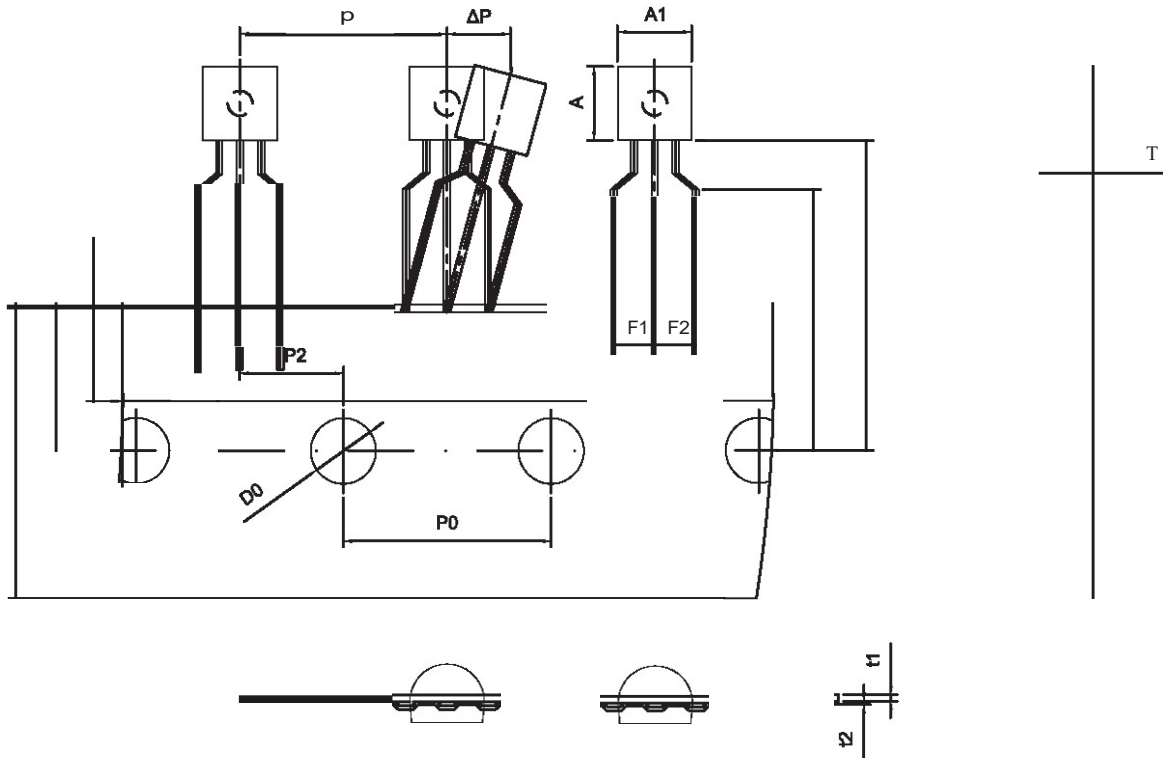
T0-92 PACKAGE TAPING DIMENSION

Dimiensions are in millimeter

A1	A	T	p	P0	P2	F1	F2	W
4.5	4.5	3.5	12.7	12.7	6.35	2.5	2.5	18.0
W0	W1	W2	H	H0	DO	t1	t2	.6.P
6.0	9.0	1.0 MAX.	19.0	16.0	4.0	0.4	0.2	0

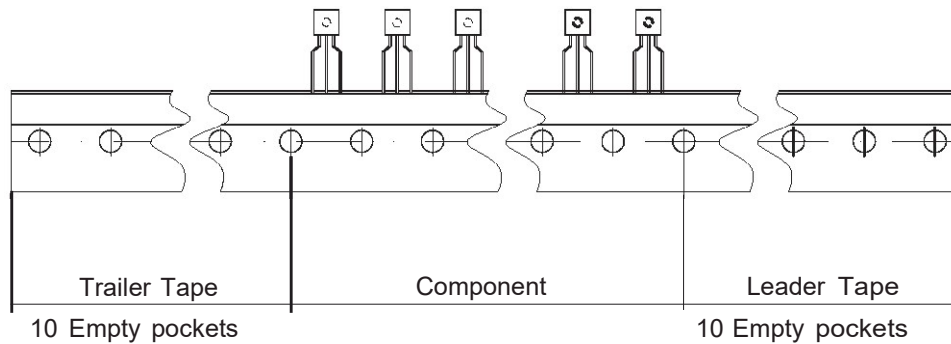

Package	Box	Box Size(mm)	Carton	Carton Size(mm)
T0-92	2000 pes	333x162x43	20,000 pes	350x340x250

T0-92 PACKAGE BULK

Package	Bag	Box	Box Size(mm)	Carton	Carton Size(mm)
T0-92	1000pcs	10,000 pcs	235x170x100	50,000 pcs	485x245x180