

8ch Darlington Sink Driver

The XD/XL2803 Series are high-voltage, high-current darlington drivers comprised of eight NPN darlington pairs.

All units feature integral clamp diodes for switching inductive loads.

Applications include relay, hammer, lamp and display (LED) drivers.

The suffix (G) appended to the part number represents a Lead (Pb)-Free product.

Features

- Output current (single output) 500 mA (Max.)
- High sustaining voltage output 50 V (Min.)
- Output clamp diodes
- Inputs compatible with various types of logic.

Type	Input Base Resistor	Designation
XD/XL2803	2.7 k Ω	TTL, 5 V CMOS

Pin Connection (top view)

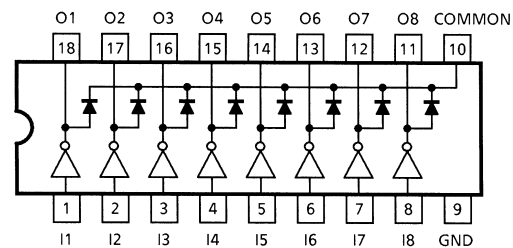

Schematics (each driver)

XD/XL2803

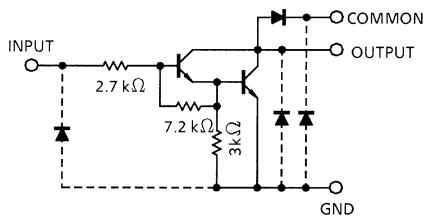

Note: The input and output parasitic diodes cannot be used as clamp diodes.

Absolute Maximum Ratings (Ta = 25°C)

Characteristic	Symbol	Rating	Unit
Output sustaining voltage	V _{CE(SUS)}	-0.5~50	V
Output current	I _{OUT}	500	mA / ch
Input voltage	V _{IN}	-0.5~30	V
Clamp diode reverse voltage	V _R	50	V
Clamp diode forward current	I _F	500	mA
Power dissipation	P _D	147	W
		0.92 / 1.31 (Note)	
Operating temperature	T _{opr}	-40~85	°C
Storage temperature	T _{stg}	-55~150	°C

Note: On Glass Epoxy PCB (75 × 114 × 1.6 mm Cu 20%)

Recommended Operating Conditions (Ta = -40~85°C)

Characteristic		Symbol	Test Condition	Min	Typ.	Max	Unit
Output sustaining voltage		V _{CE (SUS)}		0	—	50	V
Output current	XD2803	I _{OUT}	T _{pw} = 25 ms, Duty = 10%, 8 Circuits	0	—	347	mA / ch
			T _{pw} = 25 ms, Duty = 50%, 8 Circuits	0	—	123	
	XL2803AG		T _{pw} = 25 ms, Duty = 10%, 8 Circuits	0	—	268	
			T _{pw} = 25 ms, Duty = 50%, 8 Circuits	0	—	90	
Input voltage		V _{IN}		0	—	30	V
Input voltage (Output on)	XD/XL2803	V _{IN (ON)}		3.5	—	30	V
Clamp diode reverse voltage		V _R		—	—	50	V
Clamp diode forward current		I _F		—	—	400	mA
Power dissipation	XD2803	P _D	Ta = 85°C	—	—	0.76	W
	XL2803AG		Ta = 85°C (Note)	—	—	0.48	

Note: On Glass Epoxy PCB (75 × 114 × 1.6 mm Cu 20%)

Electrical Characteristics (Ta = 25°C)

Characteristic		Symbol	Test Cir-Cuit	Test Condition	Min	Typ.	Max	Unit
Output leakage current		I_{CEX}	1	$V_{CE} = 50\text{ V}$ $T_a = 25^\circ\text{C}$	—	—	50	μA
				$V_{CE} = 50\text{ V}$ $T_a = 85^\circ\text{C}$	—	—	100	
Collector-emitter saturation voltage		$V_{CE}(\text{sat})$	2	$I_{OUT} = 350\text{ mA}$, $I_{IN} = 500\text{ }\mu\text{A}$	—	1.3	1.6	V
				$I_{OUT} = 200\text{ mA}$, $I_{IN} = 350\text{ }\mu\text{A}$	—	1.1	1.3	
				$I_{OUT} = 100\text{ mA}$, $I_{IN} = 250\text{ }\mu\text{A}$	—	0.9	1.1	
Input current	XD/XL2803	$I_{IN}(\text{ON})$	2	$V_{IN} = 3.85\text{ V}$	—	0.93	1.35	mA
		$I_{IN}(\text{OFF})$	4	$I_{OUT} = 500\text{ }\mu\text{A}$, $T_a = 85^\circ\text{C}$	50	65	—	μA
Input voltage (Output on)	XD/XL2803	$V_{IN}(\text{ON})$	5	$V_{CE} = 2\text{ V}$, $I_{OUT} = 200\text{ mA}$	—	—	2.4	V
				$V_{CE} = 2\text{ V}$, $I_{OUT} = 250\text{ mA}$	—	—	2.7	
				$V_{CE} = 2\text{ V}$, $I_{OUT} = 300\text{ mA}$	—	—	3.0	
DC current transfer ratio		h_{FE}	2	$V_{CE} = 2\text{ V}$, $I_{OUT} = 350\text{ mA}$	1000	—	—	
Clamp diode reverse current		I_R	6	$T_a = 25^\circ\text{C}$ (Note)	—	—	50	μA
				$T_a = 85^\circ\text{C}$ (Note)	—	—	100	
Clamp diode forward voltage		V_F	7	$I_F = 350\text{ mA}$	—	—	2.0	V
Input capacitance		C_{IN}	—		—	15	—	pF
Turn-on delay		t_{ON}	8	$R_L = 125\text{ }\Omega$, $V_{OUT} = 50\text{ V}$	—	0.1	—	μs
Turn-off delay		t_{OFF}		$R_L = 125\text{ }\Omega$, $V_{OUT} = 50\text{ V}$	—	0.2	—	

Note: $V_R = V_R \text{ MAX.}$

Test Circuit

1. I_{CEX}

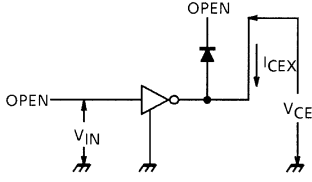

2. $V_{CE(sat)}$, h_{FE}

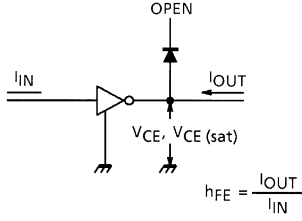

3. $I_{IN(ON)}$

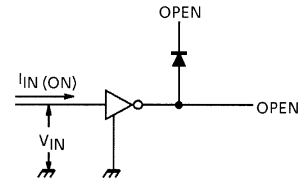

4. $I_{IN(OFF)}$

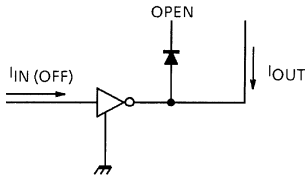

5. $V_{IN(ON)}$

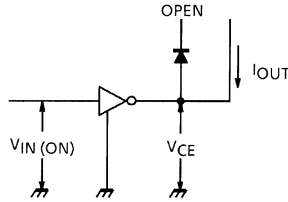

6. I_R

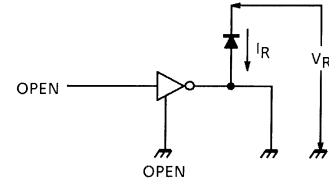

7. V_F

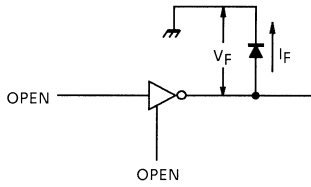

8. t_{ON} , t_{OFF}

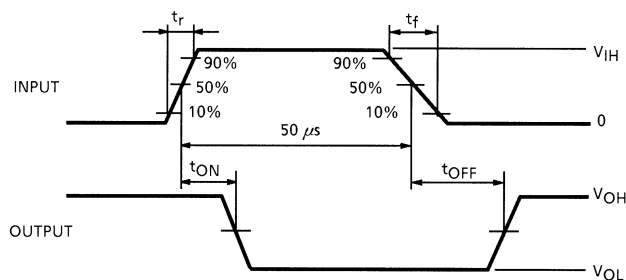
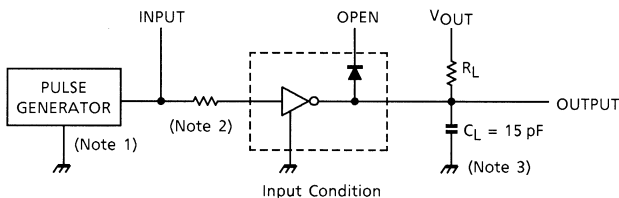

Note 1: Pulse Width 50 μ s, Duty Cycle 10%
Output Impedance 50 Ω , $t_r \leq 5$ ns, $t_f \leq 10$ ns

Note 2: See below.

Input Condition

Type Number	R1	V_{IH}
XD/XL2803	0 Ω	3 V

Note 3: C_L includes probe and jig capacitance

Precautions for Using

This IC does not integrate protection circuits such as overcurrent and overvoltage protectors. Thus, if excess current or voltage is applied to the IC, the IC may be damaged. Please design the IC so that excess current or voltage will not be applied to the IC.

Utmost care is necessary in the design of the output line, COMMON and GND line since IC may be destroyed due to short-circuit between outputs, air contamination fault, or fault by improper grounding.

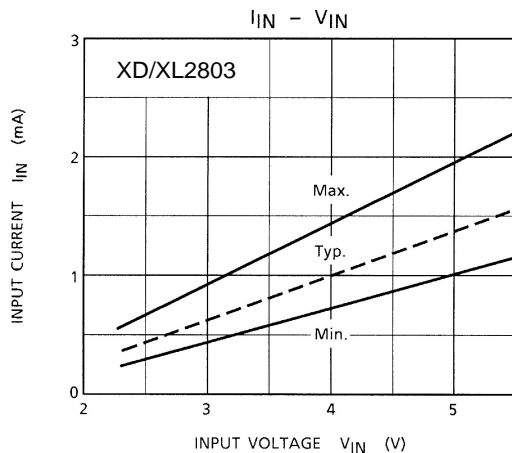

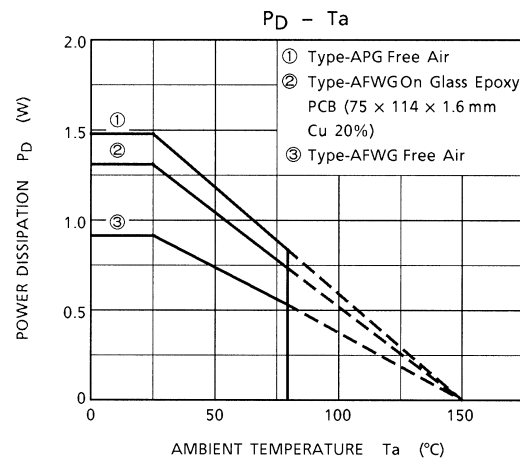
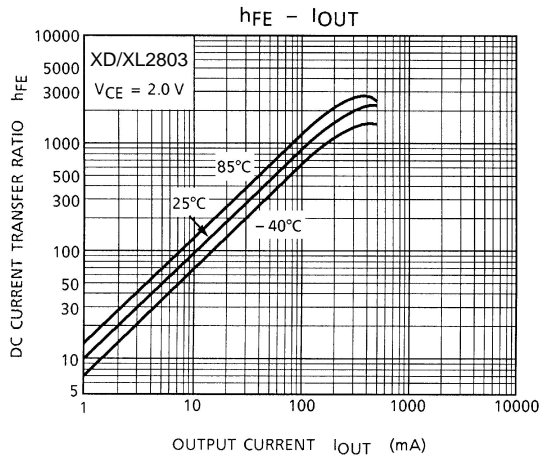
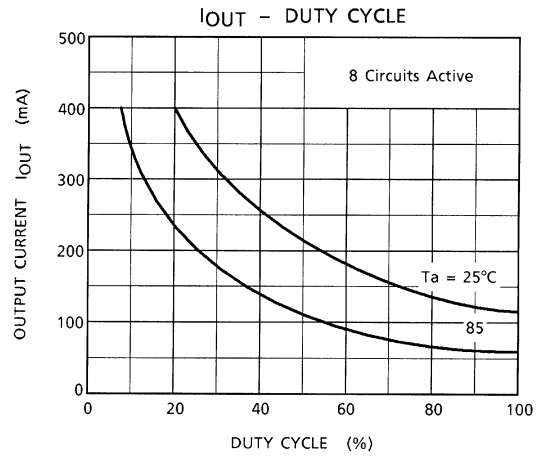
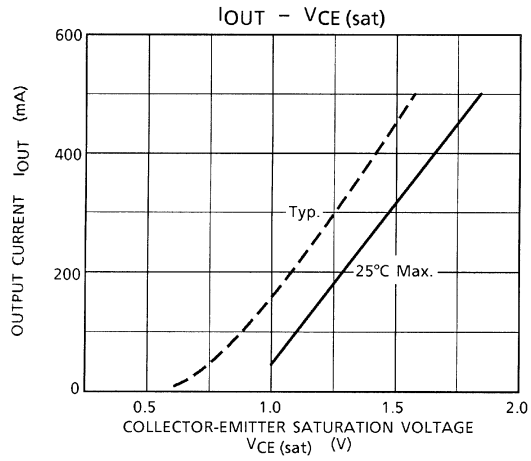

Package Dimensions

DIP18

Unit: mm

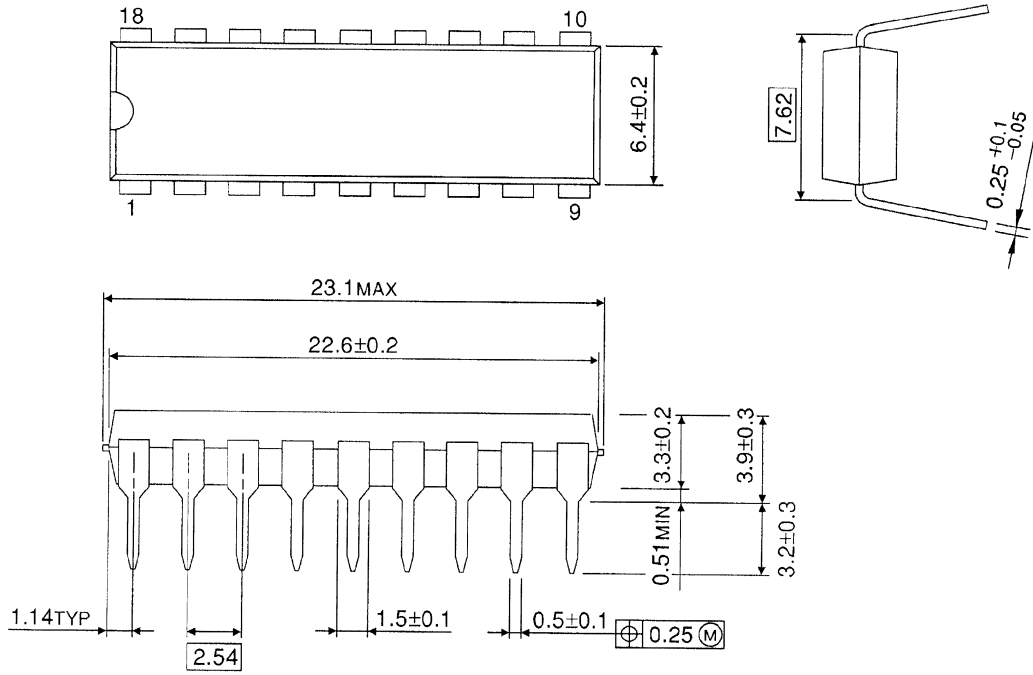

Package Dimensions

SOP-18

Unit: mm

