



Photocoupler

Product Data Sheet

6N135-L / 6N136-L series

Spec No.: DS70-2008-0032

Effective Date: 04/12/2016

Revision: A

LITE-ON DCC

RELEASE

BNS-OD-FC001/A4

Photocoupler 6N135-L 6N136-L series

1. DESCRIPTION

The 6N135/ 6N136-L consists of a high efficient AlGaAs Light Emitting Diode and a high speed optical detector. This design provides excellent AC and DC isolation between the input and output sides of the Optocoupler. Connection for the bias of the photodiode improves the speed that of a conventional phototransistor coupler by reducing the base-collector capacitances. The internal shield ensures high common mode transient immunity. A guaranteed common mode transient immunity is up to 1KV/ μ sec.

1.1 Features

- High speed – 1MBd typical
- Available in Dual-in-line, Wide lead spacing, Surface mounting package.
- Storable output.
- UL, CSA approval

1.2 Applications

- Isolation in line receivers
- Digital isolation for A/D, D/A conversion
- Ground loop elimination
- Feedback Element in Switching Mode Power Supplier
- Pulse transformer replacement
- Power transistor isolation in motor drives
- Interface between Microprocessor system, computer and their peripheral

1.3 Functional Diagram

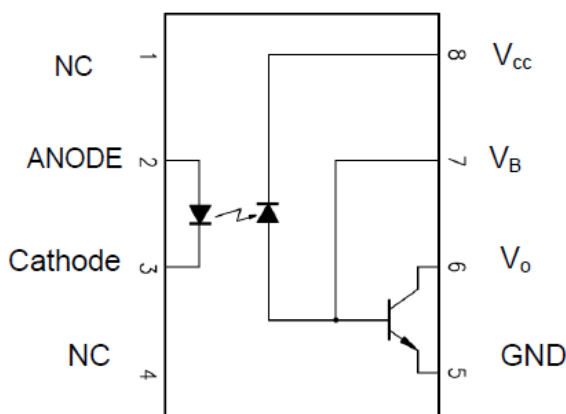

Truth Table (Positive Logic)

LED	OUT
ON	L
OFF	H

A 0.1 μ F bypass Capacitor must be connected between Pin8 and Pin5

Photocoupler 6N135-L 6N136-L series

2. PACKAGE DIMENSIONS

2.1 6N135-L

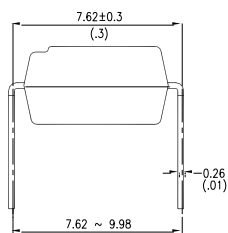
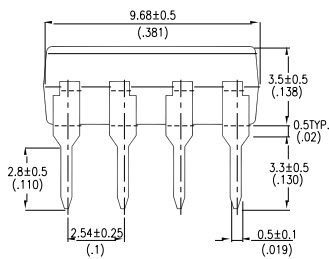
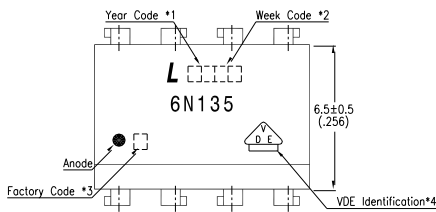

2.2 6N135M-L

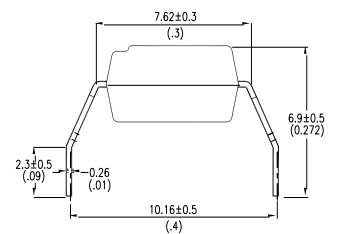
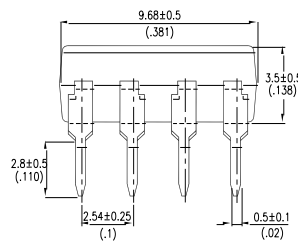
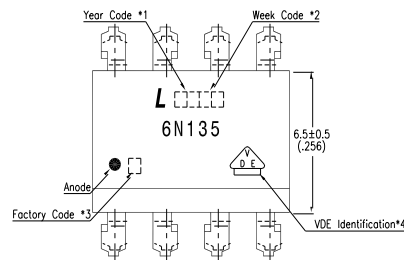

2.3 6N135S-L

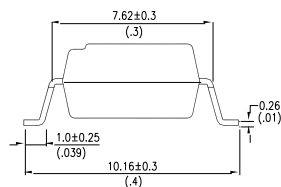
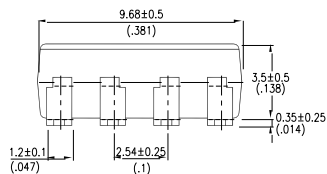
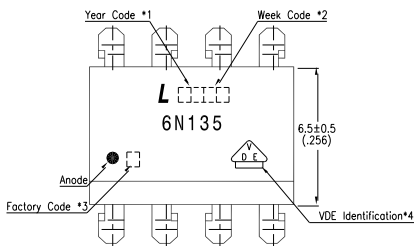

Notes :

1. Year date code.
2. 2-digit work week.
3. Factory identification mark shall be marked (Y: Thailand , W: China-CZ)
4. For VDE option.

Dimensions in millimeters (inches).

Photocoupler 6N135-L 6N136-L series

2.4 6N136-L

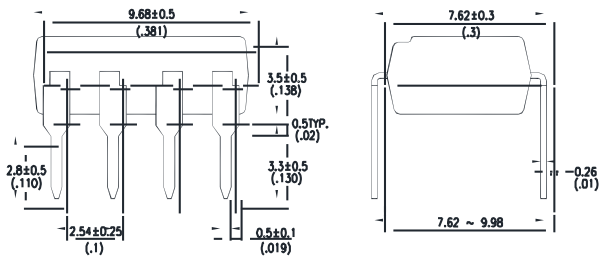
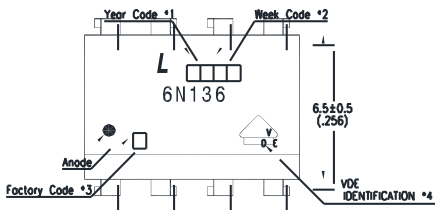

2.5 6N136M-L

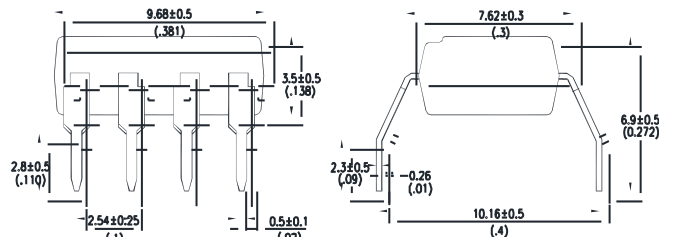
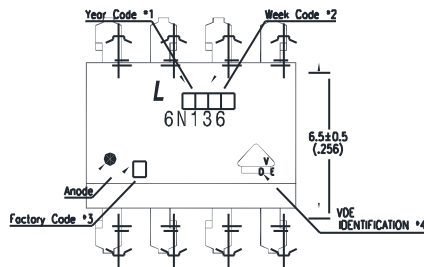

2.6 6N136S-L

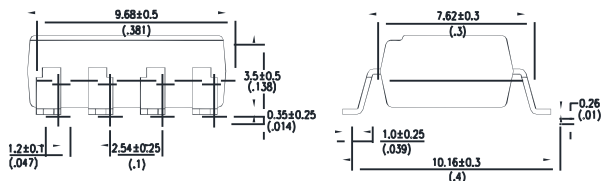
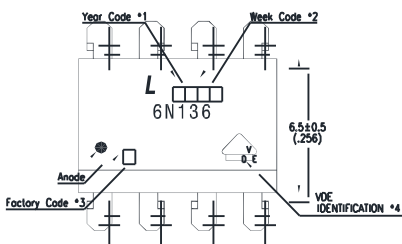

Notes :

1. Year date code.
2. 2-digit work week.
3. Factory identification mark shall be marked (Y: Thailand , W: China-CZ)
4. For VDE option.

Dimensions in millimeters (inches).

Photocoupler 6N135-L 6N136-L series

3. TAPING DIMENSIONS

3.1 6N135S-TA-L/ 6N136S-TA-L

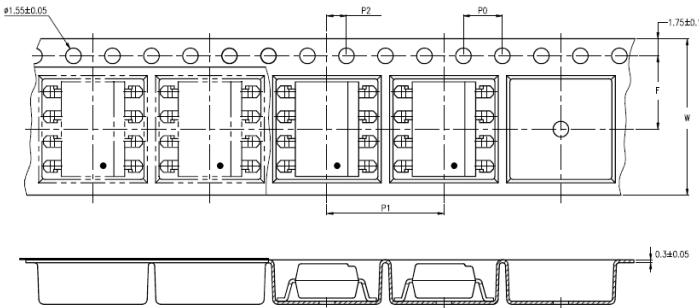

3.2 6N135S-TA1-L/ 6N136S-TA1-L

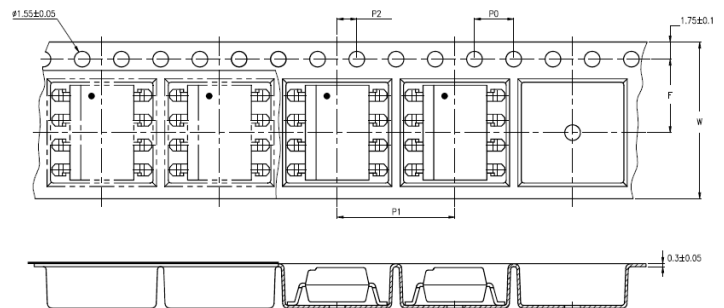

Description	Symbol	Dimension in mm (inch)
Tape wide	W	16±0.3 (0.63)
Pitch of sprocket holes	P ₀	4±0.1 (0.15)
Distance of compartment	F	7.5±0.1 (0.295)
	P ₂	2±0.1 (0.079)
Distance of compartment to compartment	P ₁	12±0.1 (0.472)

3.3 Quantities Per Reel

Package Type	TA / TA1
Quantities (pcs)	1000

Photocoupler 6N135-L 6N136-L series

4. RATING AND CHARACTERISTICS

4.1 Absolute Maximum Ratings at Ta=25°C *1

	Parameter	Symbol	Rating	Unit	Note
Input	Average Forward Input Current	I_F	25	mA	2
	Reverse Input Voltage	V_R	5	V	
	Power Dissipation	P_I	45	mW	
	Junction temperature	T_J	125	°C	
Output	Output Collector Current	I_O	8	mA	
	Output Collector Voltage	V_O	20	V	
	Output Collector Power Dissipation	P_O	100	mW	
	Junction temperature	T_J	125	°C	
	Isolation Voltage	V_{ISO}	5000	V_{rms}	
	Supply Voltage	V_{CC}	15	V	
	Operating Temperature	T_{opr}	-40 ~ +85	°C	
	Storage Temperature	T_{stg}	-55 ~ +125	°C	
	Lead Solder Temperature *2	T_{sol}	260	°C	

1. Ambient temperature = 25°C, unless otherwise specified. Stresses exceeding the absolute maximum ratings can cause permanent damage to the device. Exposure to absolute maximum ratings for long periods of time can adversely affect reliability.
2. 260°C for 10 seconds. Refer to Lead Free Reflow Profile.

Photocoupler 6N135-L 6N136-L series

4.2 ELECTRICAL OPTICAL CHARACTERISTICS at $T_A = 25^\circ\text{C}$

Parameters	Test Condition	Symbol	Device	Min	Typ	Max	Units
Input							
Input Forward Voltage	$I_F = 16\text{mA}$, $T_A = 25^\circ\text{C}$	V_F	6N135		1.4	1.7	V
Input Reverse Voltage	$I_R = 10\mu\text{A}$, $T_A = 25^\circ\text{C}$	BV_R	6N136	5	-	-	V
Detector							
Current transfer ratio	$I_F = 16\text{mA}$; $V_o = 0.4\text{V}$; $V_{CC} = 4.5\text{V}$; $T_A = 25^\circ\text{C}$	CTR	6N135	7	18	50	%
			6N136	19	24	50	
Logic low output voltage	$I_F = 16\text{mA}$; $V_{CC} = 4.5\text{V}$; $I_o = 1.1\text{mA}$; $T_A = 25^\circ\text{C}$	V_{OL}	6N135	-	0.18	0.4	V
			6N136	-	0.25	0.4	
Logic high output current	$I_F = 0\text{mA}$, $V_o = V_{CC} = 5.5\text{V}$; $T_A = 25^\circ\text{C}$	I_{OH}	6N135	-	-	0.5	μA
			6N136	-	-	1	
Logic low supply current	$I_F = 16\text{mA}$, $V_o = \text{open}$ ($V_{CC} = 15\text{V}$)	I_{ccL}	6N135 6N136	-	400	-	μA
Logic high supply current	$I_F = 0\text{mA}$, $V_o = \text{open}$; $T_A = 25^\circ\text{C}$ ($V_{CC} = 15\text{V}$)	I_{ccH}	6N135	-	-	1	μA
			6N136	-	-	1	

* All Typical at $T_A = 25^\circ\text{C}$

Photocoupler 6N135-L 6N136-L series

5. SWITCHING SPECIFICATION

Parameter	Test Condition	Symbol	Device	Min	Typ	Max	Units
Propagation Delay Time to Low Output Level	$T_A=25^\circ\text{C}$ ($R_L=4.1\text{K}\Omega$, $I_F=16\text{mA}$)	t_{PHL}	6N135	-	0.09	1.5	μs
	$T_A=25^\circ\text{C}$ ($R_L=1.9\text{K}\Omega$, $I_F=16\text{mA}$)		6N136	-	0.1	0.8	
Propagation Delay Time to High Output Level	$T_A=25^\circ\text{C}$ ($R_L=4.1\text{K}\Omega$, $I_F=16\text{mA}$)	t_{PLH}	6N135	-	0.8	1.5	μs
	$T_A=25^\circ\text{C}$ ($R_L=1.9\text{K}\Omega$, $I_F=16\text{mA}$)		6N136	-	0.4	0.8	
Logic High Common Mode Transient Immunity	$I_F=0\text{mA}$; $V_{\text{CM}}=10\text{Vp-p}$; $R_L=4.1\text{K}\Omega$; $T_A=25\text{C}$	$ CM_H $	6N135	1	10	-	$\text{KV}/\mu\text{s}$
	$I_F=0\text{mA}$; $V_{\text{CM}}=10\text{Vp-p}$; $R_L=1.9\text{K}\Omega$; $T_A=25\text{C}$		6N136				$\text{KV}/\mu\text{s}$
Logic Low Common Mode Transient Immunity	$I_F=0\text{mA}$; $V_{\text{CM}}=10\text{Vp-p}$; $R_L=4.1\text{K}\Omega$; $T_A=25\text{C}$	$ CM_L $	6N135	1	10	-	$\text{KV}/\mu\text{s}$
	$I_F=0\text{mA}$; $V_{\text{CM}}=10\text{Vp-p}$; $R_L=1.9\text{K}\Omega$; $T_A=25\text{C}$		6N136				$\text{KV}/\mu\text{s}$

* $T_A=0\sim 70^\circ\text{C}$, $V_{\text{CC}}=5\text{V}$, unless otherwise specified.

* All Typical at $T_A=25^\circ\text{C}$

Photocoupler 6N135-L 6N136-L series

6. ISOLATION CHARACTERISTIC

Parameter	Symbol	Min.	Typ.	Max.	Unit	Test Condition
Input-Output Insulation Leakage Current	I_{I-O}	—	—	1.0	μA	45% RH, $t = 5s$, $V_{I-O} = 3kV DC$, $T_A = 25^{\circ}C$
Withstand Insulation Test Voltage	V_{ISO}	5000	—	—	V_{RMS}	RH $\leq 50\%$, $t = 1min$, $T_A = 25^{\circ}C$
Input-Output Resistance	R_{I-O}	—	10^{12}	—	Ω	$V_{I-O} = 500V DC$

*All Typical at $T_A = 25^{\circ}C$

Notes

1. A 0.1 μF or bigger bypass capacitor for V_{CC} is needed as shown in Fig.1
2. Current Transfer Ratio is defined as the ratio of output collector current I_o , to the forward LED input current I_F , times 100.
3. The 1.9K Ω load represents 1TTL unit load of 1.6mA and the 5.6K Ω pull-up resistor.
4. The 4.1K Ω load represents 1LSTTL unit load of 0.36mA and the 6.1K Ω pull-up resistor.

Photocoupler 6N135-L 6N136-L series

7. SWITCHING TIME TEST CIRCUIT

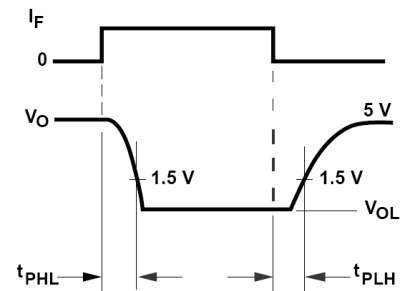
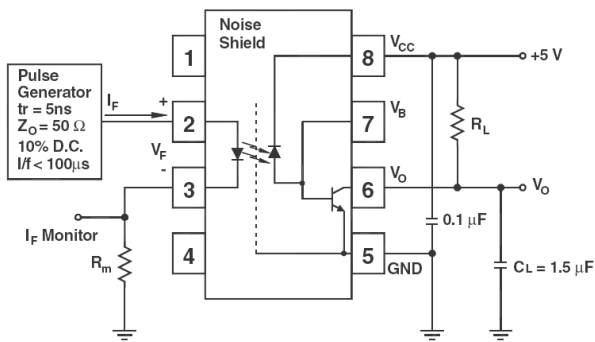

Figure 1: Test Circuit for t_{PHL} and t_{PLH}

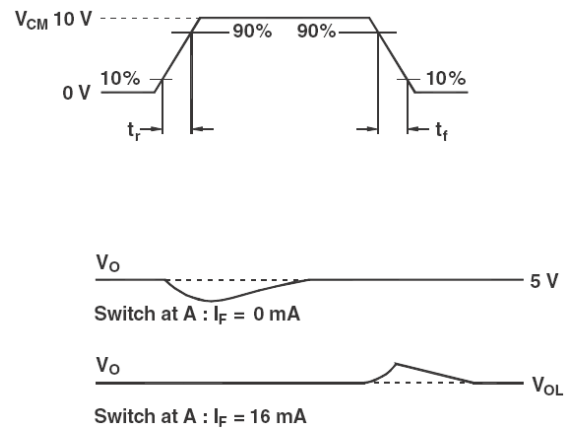
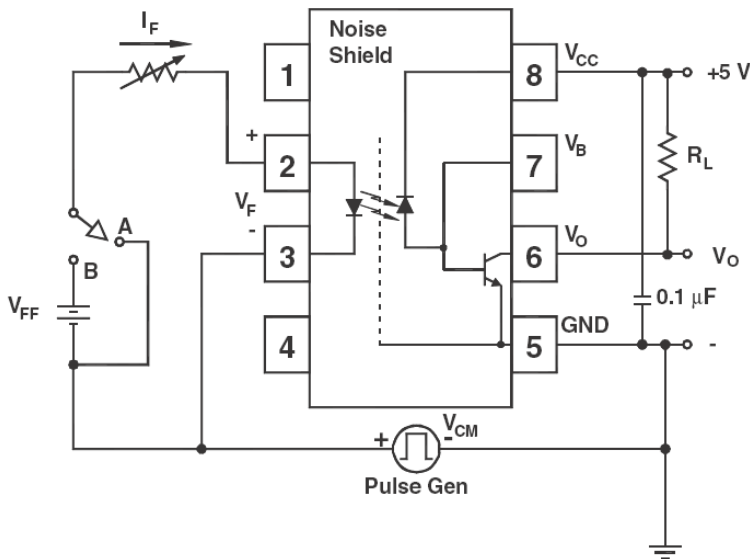

Figure 2: Single Channel Test Circuit for Common Mode Transient Immunity

Photocoupler 6N135-L 6N136-L series

8. CHARACTERISTIC CURVES

Figure 3: DC and pulsed transfer characteristics

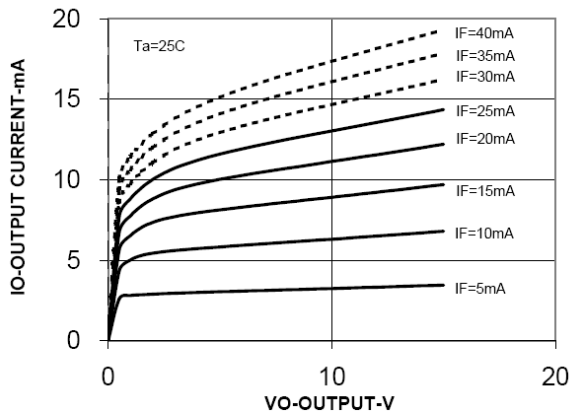

Figure 6: Current transfer ratio vs. input current

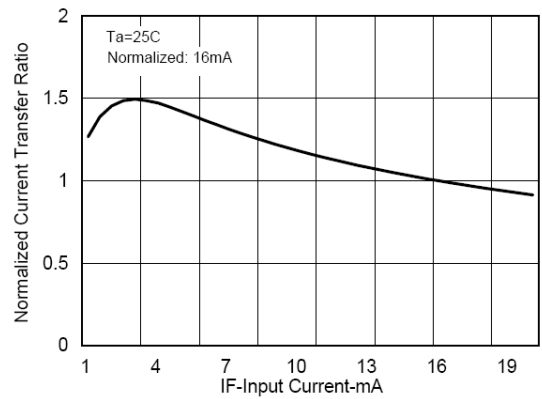

Figure 4: Input current vs. forward voltage

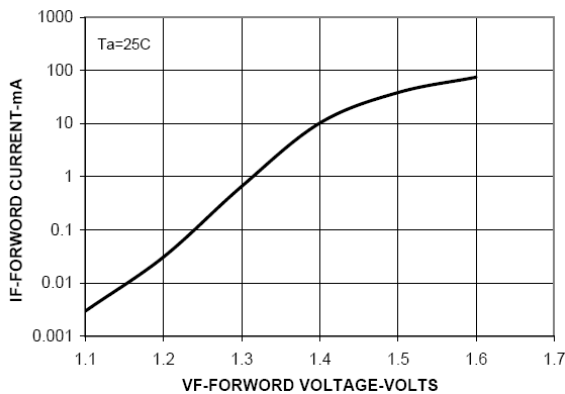

Figure 7: Current transfer ratio vs. temperature

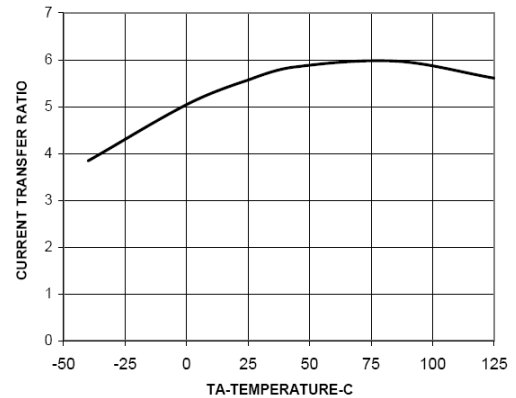

Figure 5: Logic high output current vs. temperature

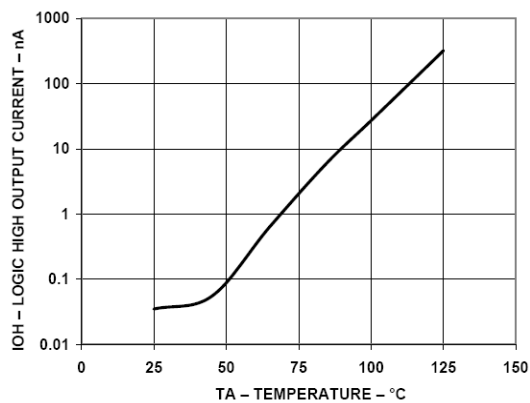
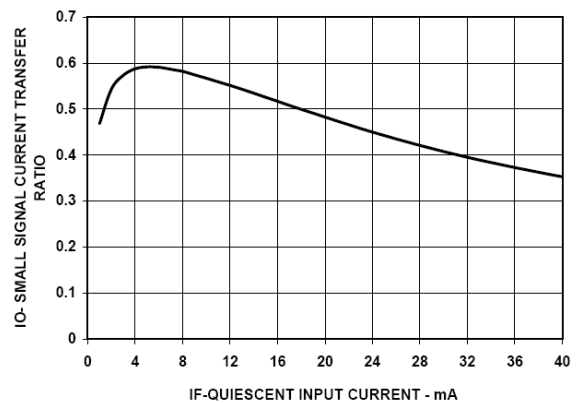

Figure 8: Small-signal current transfer ratio vs. quiescent current



**Photocoupler
6N135-L 6N136-L series**

Figure 9: Propagation delay time vs. temperature

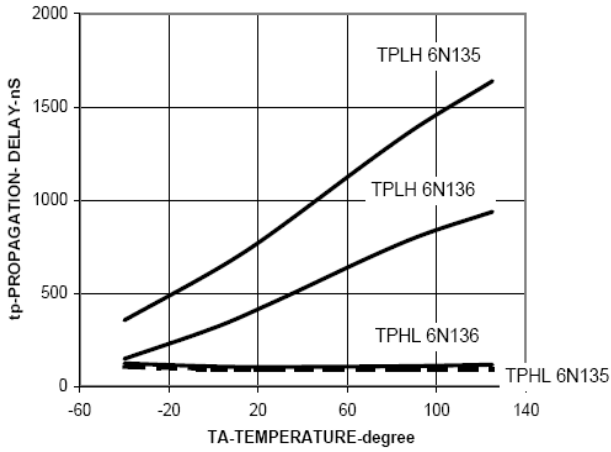
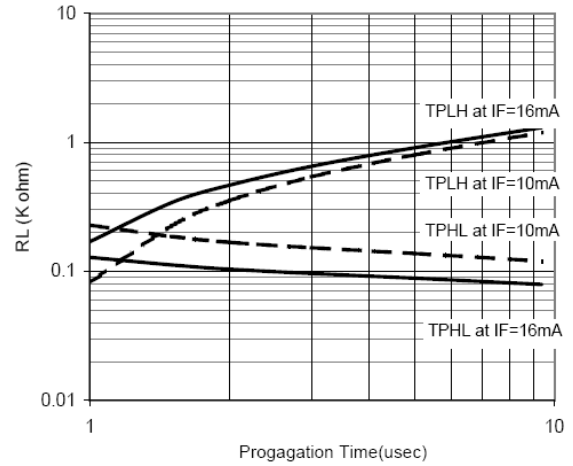

Figure 10: Propagation delay time vs. load resistance



Photocoupler 6N135-L 6N136-L series

9. TEMPERATURE PROFILE OF SOLDERING

9.1 IR Reflow soldering (JEDEC-STD-020C compliant)

One time soldering reflow is recommended within the condition of temperature and time profile shown below. Do not solder more than three times.

Profile item	Conditions
Preheat	
- Temperature Min (T_{Smin})	150°C
- Temperature Max (T_{Smax})	200°C
- Time (min to max) (ts)	90±30 sec
Soldering zone	
- Temperature (T_L)	217°C
- Time (t_L)	60 ~ 100 sec
Peak Temperature (T_P)	260°C
Ramp-up rate	3°C / sec max.
Ramp-down rate	3~6°C / sec

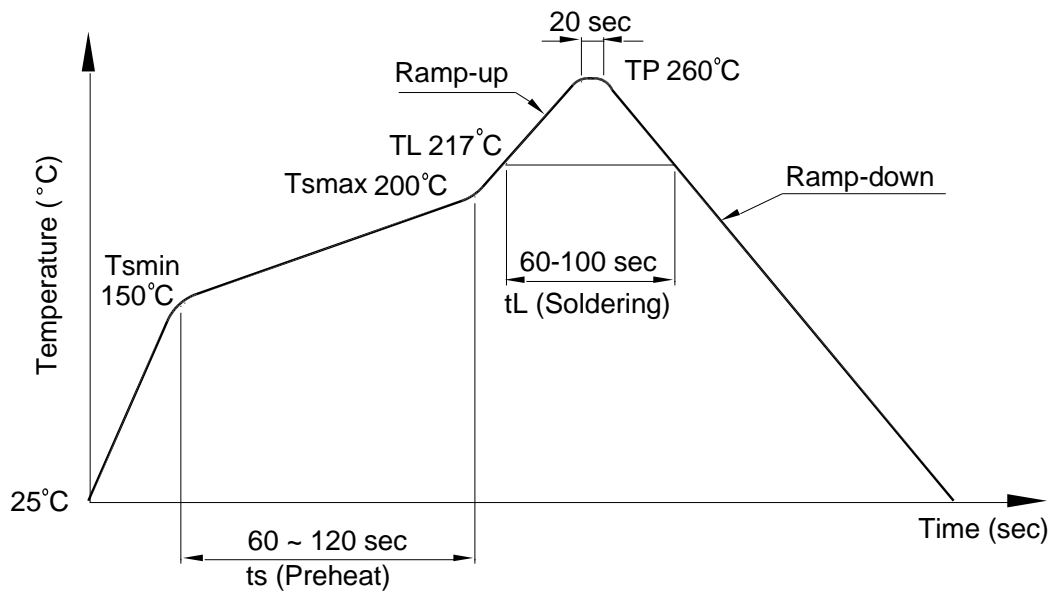

Photocoupler 6N135-L 6N136-L series

9.2 Wave soldering (JEDEC22A111 compliant)

One time soldering is recommended within the condition of temperature.

Temperature: $260 \pm 0 / -5^{\circ}\text{C}$

Time: 10 sec.

Preheat temperature: 25 to 140°C

Preheat time: 30 to 80 sec.

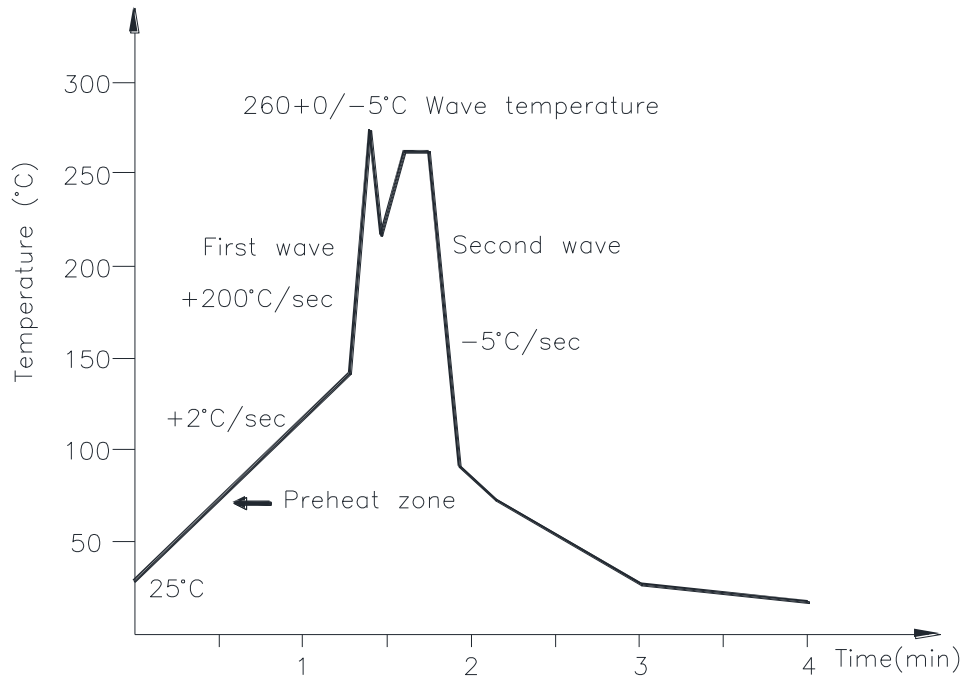

9.3 Hand soldering by soldering iron

Allow single lead soldering in every single process. One time soldering is recommended.

Temperature: $380 \pm 0 / -5^{\circ}\text{C}$

Time: 3 sec max.

**Photocoupler
6N135-L 6N136-L series**

10. RECOMMENDED FOOT PRINT PATTERNS (MOUNT PAD)

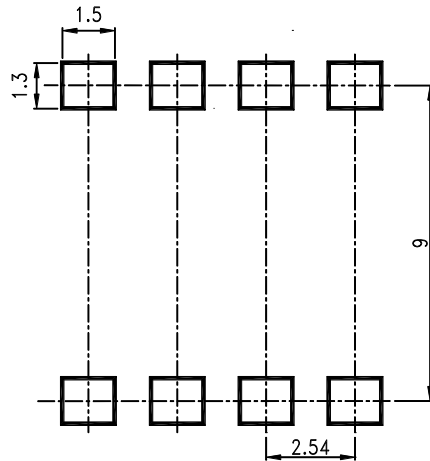

Note :

Dimensions in millimeters.

Photocoupler 6N135-L 6N136-L series

11. NAMING RULE

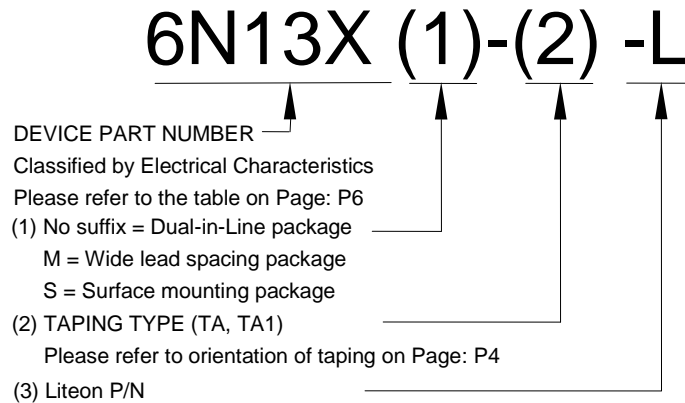

Example : 6N135S-TA1-L, 6N136S-TA1-L

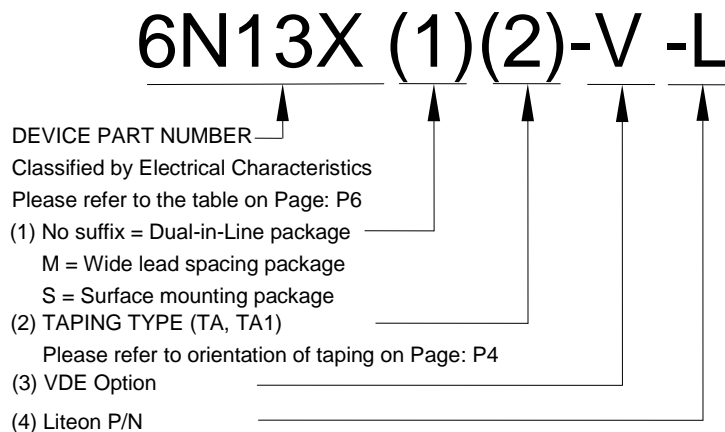

Example : 6N135STA1-V-L, 6N136STA1-V-L

12. NOTES

- LiteOn is continually improving the quality, reliability, function or design and LiteOn reserves the right to make changes without further notices.
- The products shown in this publication are designed for the general use in electronic applications such as office automation equipment, communications devices, audio/visual equipment, electrical application and instrumentation.
- For equipment/devices where high reliability or safety is required, such as space applications, nuclear power control equipment, medical equipment, etc, please contact our sales representatives.
- When requiring a device for any "specific" application, please contact our sales in advice.
- If there are any questions about the contents of this publication, please contact us at your convenience.
- The contents described herein are subject to change without prior notice.
- Immerge unit's body in solder paste is not recommended.