

## Data Sheet

Customer :

Product : Thin Film Chip Resistor - ARG Series

Size: 0402/0603/0805/1206

Issued Date: 22-May-19

Edition : REV. A5



VIKING TECH CORPORATION  
光頡科技股份有限公司

No.70, Guangfu N. Rad.,  
Hsin Chu Industrial Park,  
Hukou Hsiang, Hsin Chu Hsien,  
303, Taiwan

TEL:886-3-5972931

FAX:886-3-5972935•886-3-5973494

E-mail:sales@viking.com.tw

VIKING TECH CORPORATION KAOHSIUNG BRANCH  
光頡科技股份有限公司高雄分公司

No.248-3, Sin-Sheng Rd., Cian-Jhen Dist., Kaohsiung,  
806, Taiwan

TEL:886-7-8217999

FAX:886-7-8228229

E-mail:sales@viking.com.tw

Viking Electronics (WUXI) CO., LTD.  
光頡電子(無錫)有限公司

No.1A,(Xixia Road),Machinery & Industry Park,  
National Hi-Tech Industrial Development Zone of  
Wuxi, Wuxi, Jiangsu Province, China

Zip Code:214028

TEL:86-510-85203339

FAX:86-510-85203667•86-510-85203977

E-mail:wuxisales@tmtec.com.tw

Produced by (QC)	Checked (QC)	Approved by (QC)	Prepared by (Sales)	Accepted by (Customer)
22-May-19	22-May-19	22-May-19		
<b>Chun</b>	<b>Ben Chang</b>	<b>Ben Chang</b>		

## Thin Film Chip Resistor (ARG Series)

### ■ Features

- Advanced thin film technology
- SMD Type designed for automatic insertion
- Wide resistance range 1ohm ~ 2.49Mega ohm

### ■ Applications

- Medical Equipment
- Testing / Measurement Equipment
- Printer Equipment
- Automatic Equipment Controller
- Converters
- Communication Device, Cell Phone, GPS, PDA



### ■ Construction

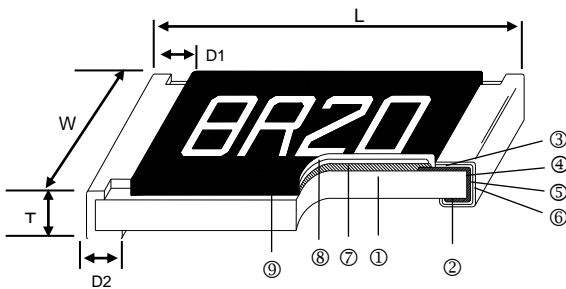

① Alumina Substrate	④ Edge Electrode	⑦ Resistor Layer
② Bottom Electrode	⑤ Barrier Layer	⑧ Overcoat
③ Top Electrode	⑥ External Electrode	⑨ Marking

### ■ Dimensions

Unit: mm

Type	Size (Inch)	L	W	T	D1	D2	Weight (g) (1000pcs)
ARG02	0402	1.00±0.05	0.50±0.05	0.30±0.10	0.20±0.10	0.20±0.10	0.54
ARG03	0603	1.60±0.10	0.80±0.10	0.45±0.10	0.30±0.20	0.30±0.20	1.83
ARG05	0805	2.00±0.15	1.25±0.15	0.50±0.10	0.30±0.20	0.40±0.20	4.71
ARG06	1206	3.10±0.15	1.55±0.15	0.55±0.10	0.42±0.20	0.35±0.25	9.02

### ■ Part Numbering

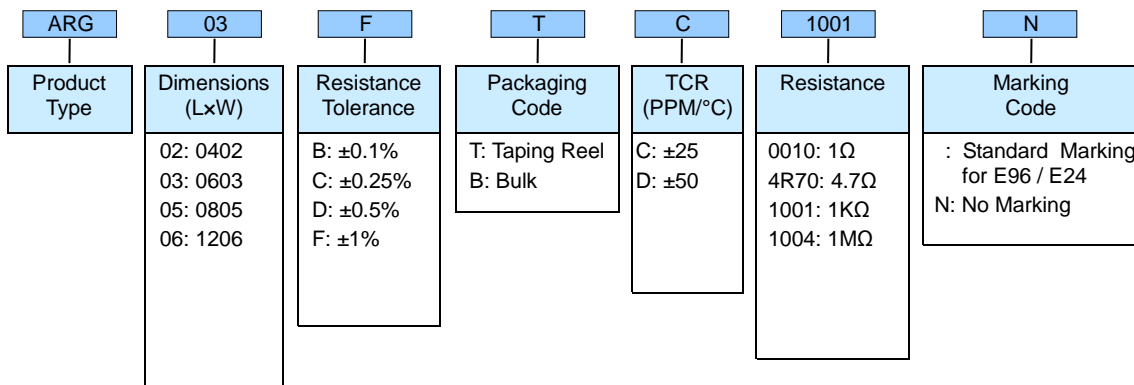

**Derating Curve**

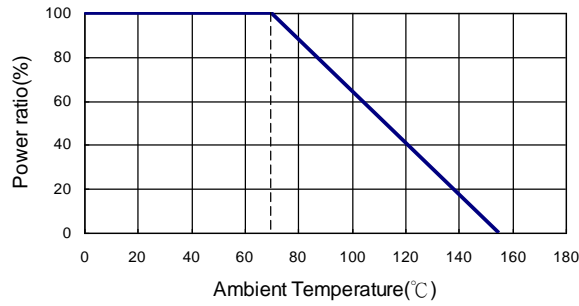

**Standard Electrical Specifications**

Type	Item	Power Rating at 70°C	Operating Temp. Range	Max. Operating Voltage	Max. Overload Voltage	Resistance Range				TCR (PPM/°C)
						±0.1%	±0.25%	±0.5%	±1%	
ARG02 (0402)		1/16W	-55 ~ +155°C	50V	100V	4.7Ω – 255KΩ				±25 ±50
ARG03 (0603)		1/10W	-55 ~ +155°C	75V	150V	1Ω - 1MΩ				±25 ±50
ARG05 (0805)		1/8W	-55 ~ +155°C	150V	300V	1Ω - 2MΩ				±25 ±50
ARG06 (1206)		1/4W	-55 ~ +155°C	200V	400V	1Ω - 2.49MΩ				±25 ±50

Operating Voltage= $\sqrt{P \cdot R}$  or Max. operating voltage listed above, whichever is lower.  
 Overload Voltage= $2.5 \cdot \sqrt{P \cdot R}$  or Max. overload voltage listed above, whichever is lower.

■Viking is capable of manufacturing the optional spec based on customer's requirement.  
**(Lower Resistance:1~10Ω ; High Power Rating)**

**■ Environmental Characteristics**

Item	Requirement	Test Method
Temperature Coefficient of Resistance (T.C.R.)	As Spec.	<b>MIL-STD-202 Method 304</b> +25/-55/+25/+125/+25°C
Short Time Overload	$\Delta R \pm 0.2\%$	<b>JIS-C-5201-1 4.13</b> RCWV*2.5 or Max. overload voltage whichever is lower for 5 seconds
Insulation Resistance	>9999 M $\Omega$	<b>MIL-STD-202 Method 302</b> Apply 100V <sub>DC</sub> for 1 minute
Endurance	$\Delta R \pm 0.5\%$	<b>MIL-STD-202 Method 108A</b> 70 $\pm 2^\circ\text{C}$ , RCWV for 1000 hrs with 1.5 hrs "ON" and 0.5 hrs "OFF"
Damp Heat with Load	$\Delta R \pm 0.5\%$	<b>MIL-STD-202 Method 103B</b> 40 $\pm 2^\circ\text{C}$ , 90~95% R.H. RCWV for 1000 hrs with 1.5 hrs "ON" and 0.5 hrs "OFF"
Bending Strength	$\Delta R \pm 0.1\%$	<b>JIS-C-5201-1 4.33</b> Bending amplitude 3 mm for 10 seconds
Solderability	95% min. coverage	<b>MIL-STD-202 Method 208H</b> 245 $\pm 5^\circ\text{C}$ for 3 seconds
Resistance to Soldering Heat	$\Delta R \pm 0.1\%$	<b>MIL-STD-202 Method 210E</b> 260 $\pm 5^\circ\text{C}$ for 10 seconds
Dielectric Withstand Voltage	By Type	<b>MIL-STD-202 Method 301</b> Max. overload voltage for 1 minute
Thermal Shock	$\Delta R \pm 0.2\%$	<b>MIL-STD-202 Method 107G</b> -55°C ~150°C, 100 cycles
Low Temperature Operation	$\Delta R \pm 0.5\%$	<b>JIS-C-5201-1 4.36</b> 1 hour, -65°C, followed by 45 minutes of RCWV
High Temperature Exposure	$\Delta R \pm 0.5\%$	<b>MIL-STD-202 Method 108</b> at +155°C for 1000 hrs

RCWV(Rated continuous working voltage)=  $\sqrt{P \cdot R}$  or Max. Operating voltage whichever is lower

■ Storage Temperature: 15~28°C; Humidity < 80%RH

**■ Soldering Condition**

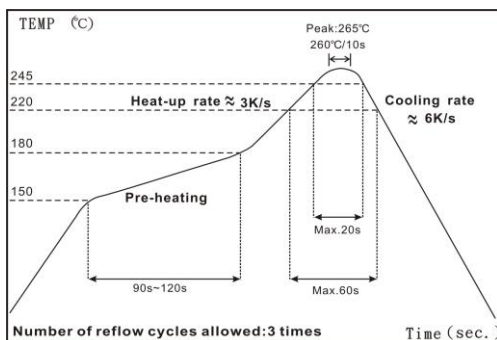

IR Reflow Soldering

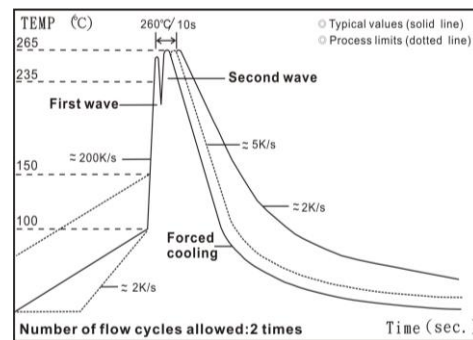

Wave Soldering (Flow Soldering)

- (1) Time of IR reflow soldering at maximum temperature point 260°C : 10s
- (2) Time of wave soldering at maximum temperature point 260°C : 10s
- (3) Time of soldering iron at maximum temperature point 410°C : 5s

**■ Marking**

0603 3digit marking



3digit marking for Example: 14C=13K7Ω 13C=13K3Ω  
68B=4K99Ω 68X=49.9Ω

Marking Table

Code	E96	Code	E96	Code	E96	Code	E96				
01	100	25	178	49	316	73	562				
02	102	26	182	50	324	74	576				
03	105	27	187	51	332	75	590				
04	107	28	191	52	340	76	604				
05	110	29	196	53	348	77	619				
06	113	30	200	54	357	78	634				
07	115	31	205	55	365	79	649				
08	118	32	210	56	374	80	665				
09	121	33	215	57	383	81	681				
10	124	34	221	58	392	82	698				
11	127	35	226	59	402	83	715				
12	130	36	232	60	412	84	732				
13	133	37	237	61	422	85	750				
14	137	38	243	62	432	86	768				
15	140	39	249	63	442	87	787				
16	143	40	255	64	453	88	806				
17	147	41	261	65	464	89	825				
18	150	42	267	66	475	90	845				
19	154	43	274	67	487	91	866				
20	158	44	280	68	499	92	887				
21	162	45	287	69	511	93	909				
22	165	46	294	70	523	94	931				
23	169	47	301	71	536	95	953				
24	174	48	309	72	549	96	976				
Code	A	B	C	D	E	F	G	H	X	Y	Z
Multiplier	10 <sup>0</sup>	10 <sup>1</sup>	10 <sup>2</sup>	10 <sup>3</sup>	10 <sup>4</sup>	10 <sup>5</sup>	10 <sup>6</sup>	10 <sup>7</sup>	10 <sup>-1</sup>	10 <sup>-2</sup>	10 <sup>-3</sup>

0603 3digit marking for E24

Example: 101=100Ω 102=1KΩ

E24	10	11	12	13	15	16	18	20	22	24	27	30	33	36	39	43	47	51	56	62	68	75	82	91
-----	----	----	----	----	----	----	----	----	----	----	----	----	----	----	----	----	----	----	----	----	----	----	----	----

0805-2512 4digit marking

Example

Resistance	100Ω	2.2KΩ	10KΩ	49.9KΩ	100KΩ
marking	1000	2201	1002	4992	1003

**■ Packaging**

Packing Quantity & Reel Specifications

Unit :mm

Type	∅A	∅B	∅C	W	T	Paper Tape (EA)	Emboss Plastic Tape (EA)
ARG02	178.0±1.0	60.0+1.0	13.5±0.7	9.5±1.0	11.5±1.0	10,000	-
ARG03	178.0±1.0	60.0+1.0	13.5±0.7	9.5±1.0	11.5±1.0	5,000	-
ARG05	178.0±1.0	60.0+1.0	13.5±0.7	9.5±1.0	11.5±1.0	5,000	-
ARG06	178.0±1.0	60.0+1.0	13.5±0.7	9.5±1.0	11.5±1.0	5,000	-



Paper Tape Specifications

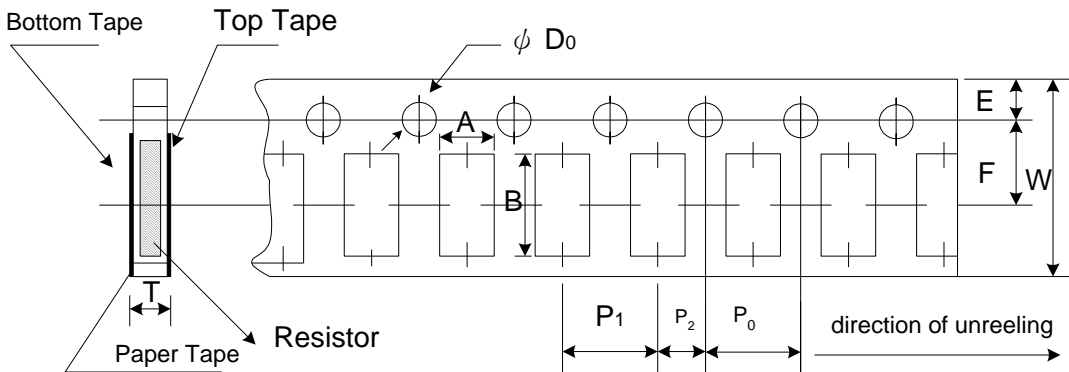

Unit: mm

Type	A	B	W	E	F	P <sub>0</sub>	P <sub>1</sub>	P <sub>2</sub>	∅D <sub>0</sub>	T
ARG02	0.70±0.05	1.16±0.05	8.00±0.10	1.75±0.05	3.5±0.05	4.00±0.10	2.00±0.05	2.00±0.05	1.55±0.05	0.40±0.03
ARG03	1.10±0.05	1.90±0.05	8.00±0.10	1.75±0.05	3.5±0.05	4.00±0.10	4.00±0.10	2.00±0.05	1.55±0.05	0.60±0.03
ARG05	1.60±0.05	2.37±0.05	8.00±0.10	1.75±0.05	3.5±0.05	4.00±0.10	4.00±0.10	2.00±0.05	1.55±0.05	0.75±0.05
ARG06	2.00±0.05	3.55±0.05	8.00±0.10	1.75±0.05	3.5±0.05	4.00±0.10	4.00±0.10	2.00±0.05	1.55±0.05	0.75±0.05

- Peel force of top cover tape
- The peel speed shall be about 300mm/min±5%
- The peel force of top cover tape shall be between 8gf to 60gf

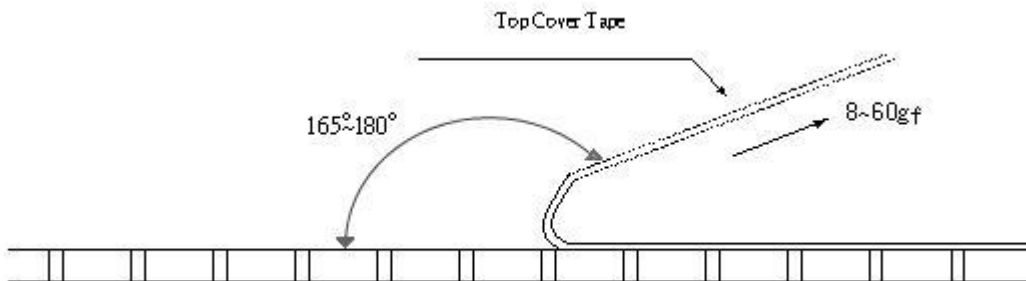

Unit: mm

■ Recommend Land Pattern

Unit: mm

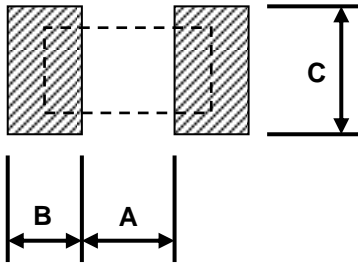

Type	A	B	C
ARG02	0.50	0.50	0.60±0.2
ARG03	0.80	1.00	0.90±0.2
ARG05	1.00	1.00	1.35±0.2
ARG06	2.00	1.15	1.70±0.2

**REVISION HISTORY**

<b>REVISION</b>	<b>DATE</b>	<b>CHANGE NOTIFICATION</b>	<b>DESCRIPTION</b>
Version A1	May 08, 2015	-	- Correct the element of Top Electrode.
Version A2	May 02, 2016	-	- Modify Storage Temperature. - Remove Material Description.
Version A3	July 19, 2016	-	- Add Resistance Range ( $\pm 0.1\%$ and $0.25\%$ ) - Update requirements of Environmental Characteristics.
Version A4	Nov 10, 2016	-	- Correct the reference standard in Environmental Characteristics.
Version A5	May 22, 2019	-	- Add High Temperature Exposure in Environmental Characteristics.