

Dwg. No. : H20-0433

承認字號

Issued Date: 2020/3/16

Customer : 日鑫股份有限公司  
(客 戶)

Part No. : \_\_\_\_\_  
(貴公司料號)

# SPECIFICATION FOR APPROVAL

## 承 認 書

Description : V-CHIP ALUMINUM ELECTROLYTIC CAPACITORS  
(零件名稱)

Lelon Series : VUA Series  
(立隆系列)

Lelon Part No.: VUA221M1ETR-0810  
(立隆料號)

### LELON ELECTRONICS CORP.

立隆電子工業股份有限公司

#### Headquarters

147, Sec. 1, Guoguang Rd., Dali District, Taichung, Taiwan  
TEL: +886-4-24181856 FAX: +886-4-24181906

#### Manufacturing Sites

Lelon Electronics Corp.  
147, Sec. 1, Guoguang Rd., Dali District, Taichung, Taiwan  
TEL: +886-4-24181856 FAX: +886-4-24181906

Lelon Electronics (Huizhou) Co., Ltd.  
Taiyang Industrial Zone, Baihua Town, Huidong County, Huizhou City,  
Guangdong, China  
TEL: +86-752-8768222 FAX: +86-752-8768199

Lelon Electronics (Suzhou) Co., Ltd.  
1220, Zhongshan North Rd., Wujiang Economic and Technological Technological  
Development Zone Suzhou City, Jiangsu, China  
TEL: +86-512-63457588 FAX: +86-512-63457791

#### Approval Signatures

貴公司承認印

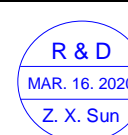
Approval 核准	Check 確認	Design 作成
		

Please Return One Copy with Your Approval  
承認後請寄回本圖一份

## Part Numbering System

### Product Code Guide – SMD Type

VE series	10μF	±20%	16V	Carrier Tape		4φ×5.3L	Pb-free and PET coating case	
<b>VE-</b>	<b>100</b>	<b>M</b>	<b>1C</b>	<b>TR</b>	<b>-</b>	<b>0405</b>		
□□□	□□□	□	□□	□□	□	□□□□	□	
①	②	③	④	⑤	⑥	⑦	⑧	⑨
Series	Capacitance	Capacitance Tolerance	Rated Voltage	Package Type	Terminal Type	Case size	Lead Wire and Coating Type	Supplement Code

**① Series:**

Series is represented by a three-letter code. When the series name only has two letters, use a hyphen, “-”, to fill the third blank.

**② Capacitance:**

Capacitance in μF is represented by a three-digit code. The first two digits are significant and the third digit indicates the number of zeros following the significant figure. “R” represents the decimal point for capacitance under 10μF.

Example:

Capacitance	0.1	0.47	1	4.7	10	47	100	470	1,000	4,700	10,000
Part number	0R1	R47	010	4R7	100	470	101	471	102	472	103

**③ Tolerance:**

J = -5% ~ +5%	K = -10% ~ +10%	M = -20% ~ +20%	V = -10% ~ +20%
---------------	-----------------	-----------------	-----------------

**④ Rated voltage:**

Rated voltage in volts (V) is represented by a two-digit code

Voltage (WV)	2.5	4	6.3	10	16	20	25	35	40	50	63	80	100
Code	0E	0G	0J	1A	1C	1D	1E	1V	1G	1H	1J	1K	2A
Voltage (WV)	160	200	250	350	400	450							
Code	2C	2D	2E	2V	2G	2W							

**⑤ Package:**

TR = Reel package	T = Tray package for case diameter 12.5 ~ 18mm
-------------------	--

**⑥ Terminal:**

- = No dummy terminal	K = Anti-vibration structure (30G)
A = For automotive application (10G)	G = Anti-vibration structure (50G)

**⑦ Case size:**

The first two digits indicate case diameter and the last two digits indicate case length in mm.

φD×L	3×5.3	4×4.5	4×5.3	4×5.7	5×4.5	5×5.3	5×5.7 5×5.8	6.3×4.5	6.3×5.3	6.3×5.7 6.3×5.8
Code	<b>0305</b>	<b>0404</b>	<b>0405</b>	<b>0406</b>	<b>0504</b>	<b>0505</b>	<b>0506</b>	<b>0604</b>	<b>0605</b>	<b>0606</b>
φD×L	6.3×7.7	8×6.5	8×10	10×7.7	10×10(9.9)	10×12.5	12.5×13.5	12.5×16	16×16.5	16×21.5
Code	<b>0607</b>	<b>0806</b>	<b>0810</b>	<b>1008</b>	<b>1010</b>	<b>1013</b>	<b>1313</b>	<b>1316</b>	<b>1616</b>	<b>1621</b>
φD×L	18×16.5	18×21.5								
Code	<b>1816</b>	<b>1821</b>								

Note 1: When a case size is required and not shown in the table, please contact with us for further discussion.

Note 2: The case size “5×5.8, 6.3×5.8” is for VZS series only.

**⑧ Lead Wire and Coating Type:**

None = Pb free wire + PET coating case (Standard design)	E = Sn-Bi wire + PET coating case
B = Sn-Bi wire + Coating case	K / L = Automotive control code

\* When a supplement code following a blank digit code of lead wire and case coating type (standard design), use a hyphen, “-”, to fill the blank digit.

\* When the automotive control code is required, please contact with us for further discussion.

**⑨ Supplement code (Optional):**

For special control purpose

CUSTOMER : 日鑫股份有限公司

CUSTOMER P/N:

PRODUCT DIMENSIONS

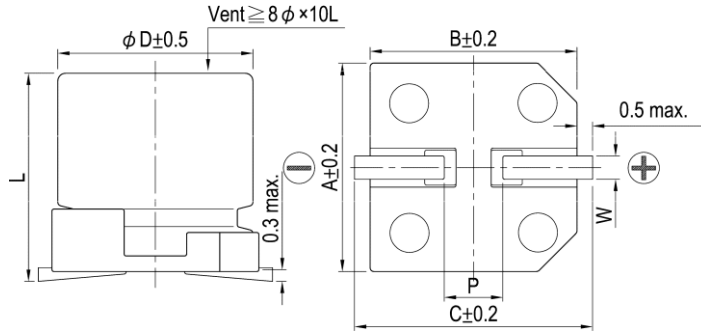

Unit: mm

$\phi$ D	8
L	10 $\pm$ 0.5
A	8.3
B	8.3
C	9.0
W	0.7~1.1
P	3.1 $\pm$ 0.2

Items	Performance															
Rated Voltage $V_R$	25 V															
Capacitance $C_R$	220 $\mu$ F (120 Hz, 20°C)															
Category Temperature Range	-40°C ~ +125°C															
Capacitance Tolerance	-20 % ~ +20 % (120 Hz, 20°C)															
Surge Voltage $V_S$	28.8 $V_{DC}$															
Leakage Current (20°C)	$I_{LEAK} \leq 165 \mu$ A After 1 minutes															
Tan $\delta$	$\leq 0.21$ (120 Hz, 20°C)															
Ripple Current ( $I_{AC, R} / rms$ )	130 mA (120 Hz, 125°C)															
Low Temperature Characteristics at 120 Hz	$Z_{(-25^\circ C)} / Z_{(+20^\circ C)}$ 4															
	$Z_{(-40^\circ C)} / Z_{(+20^\circ C)}$ 6															
Ripple Current (A) and Frequency Multipliers	<table border="1"> <tr> <td>Frequency (Hz)</td> <td>50</td> <td>120</td> <td>1k</td> <td>10k up</td> </tr> <tr> <td>Multiplier</td> <td>0.80</td> <td>1.00</td> <td>1.25</td> <td>1.40</td> </tr> </table>	Frequency (Hz)	50	120	1k	10k up	Multiplier	0.80	1.00	1.25	1.40					
	Frequency (Hz)	50	120	1k	10k up											
Multiplier	0.80	1.00	1.25	1.40												
Endurance and Shelf Life Test	<table border="1"> <tr> <td>Items</td> <td>Endurance</td> <td>Shelf Life Test</td> </tr> <tr> <td>Test Time</td> <td>2,000 Hrs at 125°C; <math>V_R</math></td> <td>1,000 Hrs at 125°C</td> </tr> <tr> <td>Cap. Change</td> <td>Within <math>\pm 30</math> % of initial value</td> <td>Within <math>\pm 30</math> % of initial value</td> </tr> <tr> <td>Tan <math>\delta</math></td> <td>Less than 300% of specified value</td> <td>Less than 300% of specified value</td> </tr> <tr> <td>Leakage Current</td> <td>Within specified value</td> <td>Within specified value</td> </tr> </table>	Items	Endurance	Shelf Life Test	Test Time	2,000 Hrs at 125°C; $V_R$	1,000 Hrs at 125°C	Cap. Change	Within $\pm 30$ % of initial value	Within $\pm 30$ % of initial value	Tan $\delta$	Less than 300% of specified value	Less than 300% of specified value	Leakage Current	Within specified value	Within specified value
	Items	Endurance	Shelf Life Test													
	Test Time	2,000 Hrs at 125°C; $V_R$	1,000 Hrs at 125°C													
	Cap. Change	Within $\pm 30$ % of initial value	Within $\pm 30$ % of initial value													
	Tan $\delta$	Less than 300% of specified value	Less than 300% of specified value													
Leakage Current	Within specified value	Within specified value														
Standards	JIS C 5101-1, -18, IEC 60384-4															
Remarks	RoHS Compliance, Halogen-free															

Marking: Each capacitor shall be marked with the following information

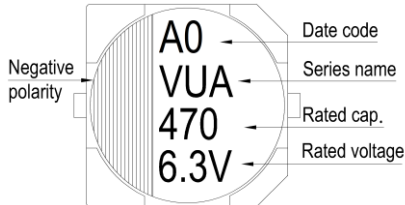

A 0  $\rightarrow$  January, 2020  
 The suffix of A. D.  
 Month of manufacture

Month	1	2	3	4	5	6
Code	A	B	C	D	E	F
Month	7	8	9	10	11	12
Code	G	H	I	J	K	L

Marking color: Black

\* Please refer to "Precautions and Guidelines for Aluminum Electrolytic Capacitors" section in Lelon's catalog for further details.

Publication Date	March 14, 2020	Approval Signatures:	Approved	Checked	Designed
Revision Date					
Version No.	1		Please return one copy with your approval		

Diagram of Dimensions:

Unit: mm

Fig. 1

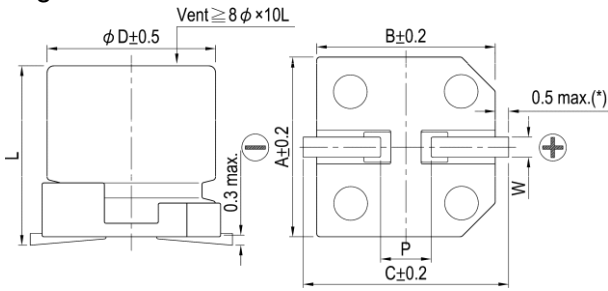
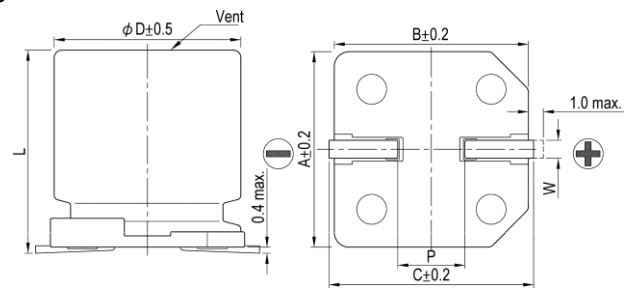

Fig. 2



(\*): For 3 ~ 6.3φ is 0.4 max.

φD	L	A	B	C	W	P ± 0.2	Fig. No.
6.3	5.7 ± 0.3	6.6	6.6	7.2	0.5 ~ 0.8	2.0	1
6.3	7.7 ± 0.3	6.6	6.6	7.2	0.5 ~ 0.8	2.0	1
8	6.5 ± 0.3	8.3	8.3	9.0	0.5 ~ 0.8	2.3	1
8	10 ± 0.5	8.3	8.3	9.0	0.7 ~ 1.1	3.1	1
10	10 ± 0.5	10.3	10.3	11.0	0.7 ~ 1.3	4.7	1
12.5	13.5 ± 0.5	13.0	13.0	13.7	1.1 ~ 1.4	4.4	2
12.5	16 ± 0.5	13.0	13.0	13.7	1.1 ~ 1.4	4.4	2
16	16.5 ± 0.5	17.0	17.0	18.0	1.1 ~ 1.4	6.4	2
18	16.5 ± 0.5	19.0	19.0	20.0	1.1 ~ 1.4	6.4	2

Marking:

Each capacitor shall be marked with the following information.

φD = 6.3 mm

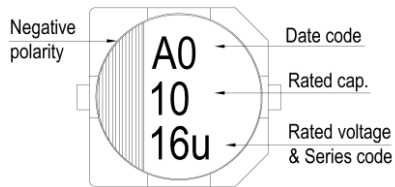

φD = 8 ~ 10 mm

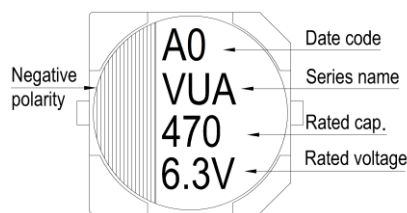

φD ≥ 12.5 mm

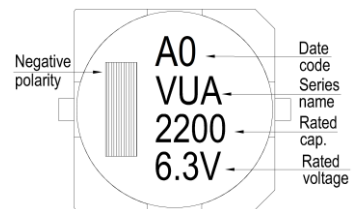

Description of Date Code:

A 0 → January, 2020

→ The last digit of A. D.  
→ Month of manufacture

Month	1	2	3	4	5	6
Code	<b>A</b>	<b>B</b>	<b>C</b>	<b>D</b>	<b>E</b>	<b>F</b>
Month	7	8	9	10	11	12
Code	<b>G</b>	<b>H</b>	<b>I</b>	<b>J</b>	<b>K</b>	<b>L</b>

Origin code:

Huizhou: A0 , B0 , ... , K0, L0  
Suzhou: 0A , 0B , ... , 0K , 0L

Marking Color: Black

# Taping Specification for SMD Type

## 1. Carrier Tape

Fig. 1-1

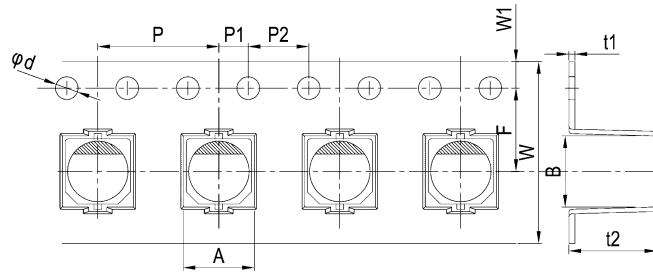

Fig. 1-2

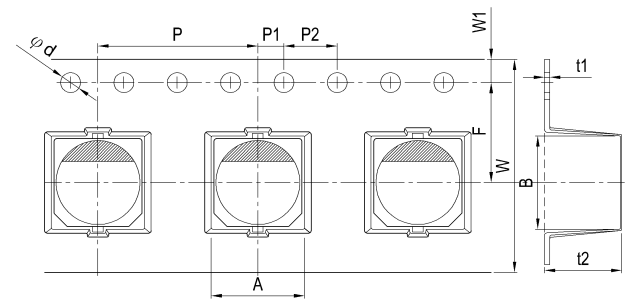
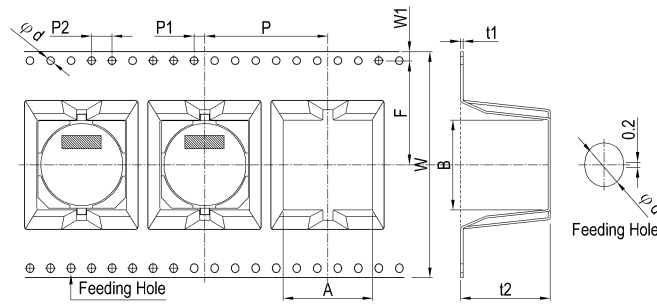

Fig. 1-3



Unit: mm

$\phi D \times L$	A	B	$\phi d$	F	P	P1	P2	t1	t2	W	W1	Fig. No.	
3~4 x4.5	4.5	4.5	1.5	5.5	8	2.0	4.0	0.4	4.8	12.0	1.75	1-1	
4 x5.3	4.5	4.5		5.5	8				5.8				
4 x5.7	4.5	4.5		5.5	8				6.3				
5 x4.5	5.5	5.5		5.5	12				4.8				
5 x5.3	5.5	5.5		5.5	12				5.9				
5 x5.7 ~ 5.8	5.5	5.5		5.5	12				6.3				
6.3 x4.5	6.8	6.8		7.5	12				4.8				
6.3 x5.3	6.8	6.8		7.5	12				5.9				16.0
6.3 x5.7 / 5.8	6.8	6.8							6.3				
6.3 x7.7	6.8	6.8							8.3				
6.3 x8.7	6.8	6.8	9.3										
6.3 x9.5	6.8	6.8	11.5			16	0.5	10.6	24.0	1-2			
8 x6.5	8.7	8.7	7.5	12	6.9	16.0							
8 x9.5~10	9.4	9.4	11.5	16	11.0	24.0							
8 x10.5(G)					11.4								
10 x7.7					8.7								
10 x10	10.7	10.7	11.0	17.5	11.0	32.0							
10 x10.5(G)	11.4												
10 x12.5	10.7	10.7			13.1								
10 x16.5	10.7	10.7			17.5								
12.5 x13.5	13.4	13.4			14.5		0.5	44.0					
12.5 x13.5(G)	13.7	13.7	15.0										
12.5 x16	13.4	13.4	17.0										
12.5 x16(G)	13.7	13.7	17.5										
16 x16.5	17.5	17.5	17.0	20.2	32								
16 x16.5(G)	17.5	17.5	17.5										
16 x21.5	17.5	17.5	23.0										
18 x16.5	19.5	19.5	17.5										
18 x16.5(G)	19.6	19.6	17.5										
18 x21.5	19.5	19.5	23.0			1-3							
Tol.	$\pm 0.2$	$\pm 0.2$	$+0.1/-0$	$\pm 0.1$	$\pm 0.1$		$\pm 0.1$	$\pm 0.1$	$\pm 0.1$	$\pm 0.2$	$\pm 0.3$	$\pm 0.15$	

Note: Case size in mark of "G" are for "Anti-vibration".

## 2. Reel Package

Fig. 2-1

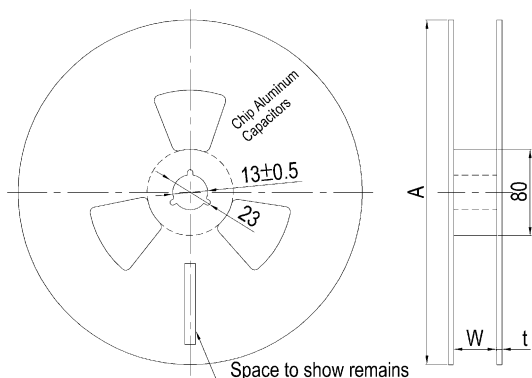
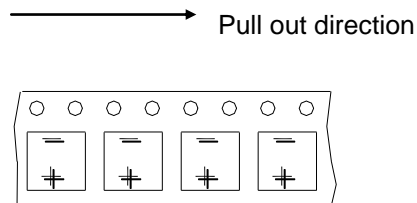

Fig. 2-2 Reel Polarity



Case size	3 ~ 4 φ	5 φ	6.3 φ	8 φ × 6.5	8 φ × 10	10 φ	12.5 φ	16 ~ 18 φ
W	14	14	18	18	26	26	34	46
A	380	380	380	380	380	380	380	380
t	3.0	3.0	3.0	3.0	3.0	3.0	3.0	3.0

## 3. Packing specification

Fig. 3-1 Carrier Tape

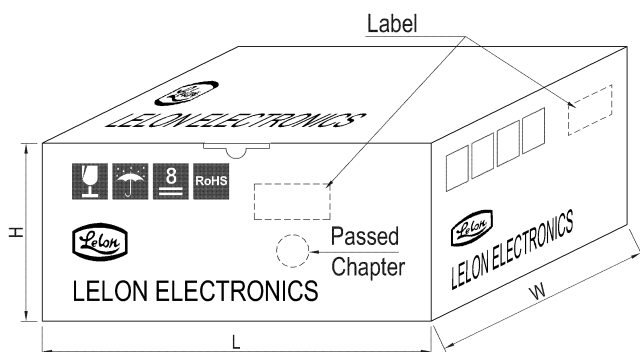

Unit: pcs

Case size	Q'ty / Reel	Q'ty / Box
3 φ	2,000	20,000
4 φ	2,000	20,000
5 φ	1,000	10,000
6.3 φ	1,000	10,000
8 φ × 6.5	1,000	10,000
8 φ × 10L	500	5,000
10 φ × 7.7 ~ 10L	500	5,000
10 φ × 12.5L	400	4,000
12.5 φ × 13.5L	200	1,600
12.5 φ × 16L	200	1,600
16 φ × 16.5L	200	1,600
16 φ × 21.5L	100	800
18 φ × 16.5L	150	1,200
18 φ × 21.5L	100	800

Unit: mm

Case size	3 ~ 4 φ	5 φ	6.3 φ	8 φ × 6.5	8 φ × 10	10 φ	12.5 φ	16 ~ 18 φ
H	210	210	250	250	330	330	330	425
W, L	395	395	395	395	395	395	395	395

Fig. 3-2 Label

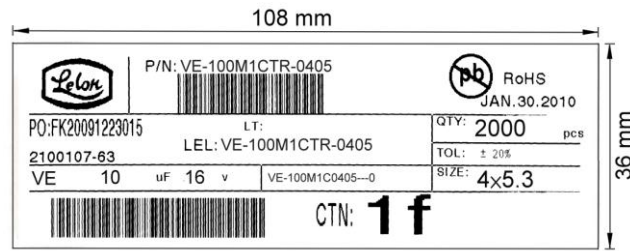

4. Chip Tray

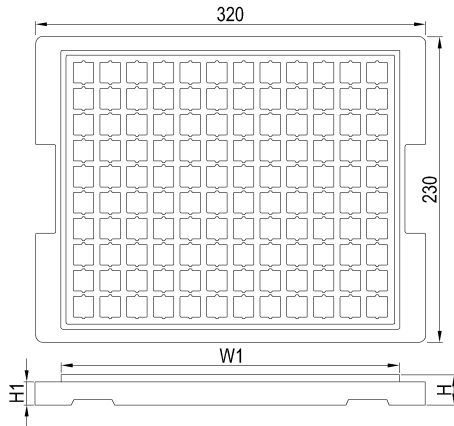

Dimension and package quantity

Case size	W1	H	H1	Q'ty / Tray	Q'ty / Box
12.5 φ × 13.5L	284	21	18.5	120	600
12.5 φ × 16L	284	21	18.5	120	600
16 φ × 16.5L	284	28	24.0	80	400
16 φ × 21.5L	284	28	24.0	80	400
18 φ × 16.5L	284	28	24.0	60	300
18 φ × 21.5L	284	28	24.0	60	300

5. Sealing Tape Reel Strength

- 5.1 Peel angle: 165 to 180°C referred to the surface on which the tape is glued.
- 5.2 Peel speed: 300mm per minutes
- 5.3 The peel strength must be 0.1 ~ 0.7N under these conditions.

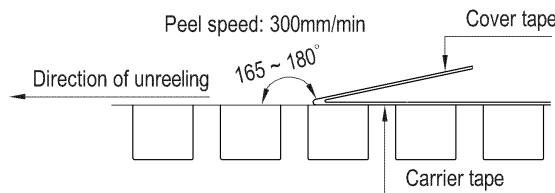

6. Packing Method

- 6.1 The leader length of the tape shall not be less than 400 mm including 10 or more embossed sections in which no parts are contained.
- 6.2 The winding core is provided with an over 160mm long empty section; punched carrier is only suitable for φ D ≤ 5 mm.

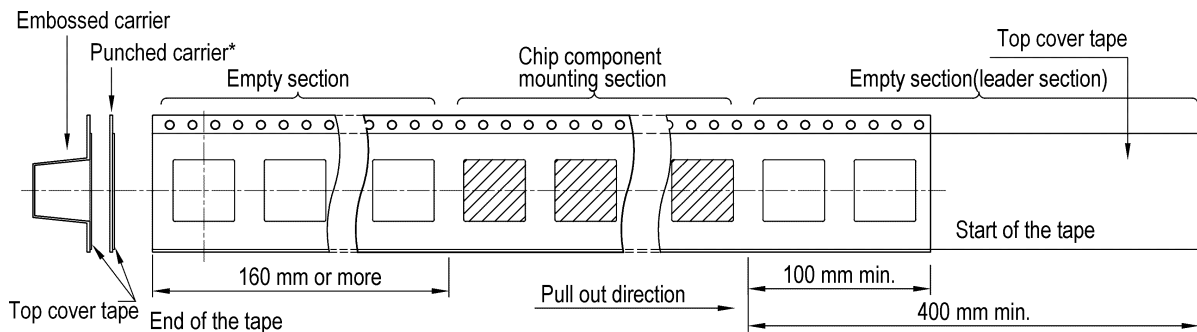

7. Other: Specifications stated above is in accordance with JIS C 0806-3.

**Endurance characteristic:**

No.	Item	Conditions	Specification	
1	Rotational Temperature Test	Capacitor is placed in an oven whose temperature follow specific regulation to change. The specific regulation is "+25°C (3 min.) → -40°C (30 min.) → +25°C (3 min.) → +125°C (30 min.) → +25°C (3 min.)", and it is called a cycle. The test totals 10 cycles, and then the capacitor shall be subjected to standard atmospheric conditions for 4 hours, after which measurements shall be made.	Capacitance change	Within ± 10% of initial value
			Tanδ	Within specified value
			Leakage Current	Within specified value
			Physical	No broken and undamaged
2	High Temperature Endurance Life Test	1. Capacitors shall be placed in oven with application of rated voltage 1,000 +48 / -0 hours for φ D ≤ 6.3 ~ 8 × 6.5 mm; 2,000 +72 / -0 hours for φ D ≥ 8 × 10 ~ 18 mm at 125°C. 2. Then the capacitor shall be subjected to standard atmospheric conditions for 4 hours, after which measurements shall be made.	Capacitance change	Within ± 30% of initial value
			Tanδ	Less than 300% of specified value
			Leakage Current	Within specified value
			Physical	No broken and undamaged
3	High Temperature Unload Life Test	After 1,000 +48 / -0 Hours test at 125°C without rated voltage. And then the capacitor shall be subjected to standard atmospheric conditions for 4 hours, after which measurements shall be made.	Capacitance change	Within ± 30% of initial value
			Tanδ	Less than 300% of specified value
			Leakage Current	Within specified value
			Physical	No broken and undamaged
4	Humidity Test	Capacitors shall be exposed for 1,000 +48 / -0 hours in an atmosphere of 90 ~ 95% R. H. at 60 ± 3°C. And then the capacitor shall be subjected to standard atmospheric conditions for 4 hours, after which measurements shall be made.	Capacitance change	Within ± 10% of initial value
			Tanδ	Less than 120% of specified value
			Leakage Current	Within specified value
			Physical	No broken and undamaged
5	Low Temperature Test	Capacitors are placed at -40 ± 3°C for 96 ± 4 hours. And then the capacitor shall be subjected to standard atmospheric conditions for 4 hours, after which measurements shall be made.	Capacitance change	Within ± 10% of initial value
			Tanδ	Within specified value
			Leakage Current	Within specified value
			Physical	No broken and undamaged
6	Vibration Test	1. Fix it at the point 4 mm or less from body. For ones of 12.5 mm or more in diameter or 25 mm or more length, use separate fixture. 2. Direction and during of vibration: 3 orthogonal directions mutually each for 2 hours (total of 6 hours). 3. Frequency: 10 to 55 Hz reciprocation for 1 minute. 4. Total amplitude: 1.5 mm	Capacitance change	Within ± 10% of initial value
			Tanδ	Within specified value
			Leakage Current	Within specified value
			Physical	No broken and undamaged
7	Surge Voltage Test	The capacitor shall be subjected to 1,000 cycles at 15 ~ 35°C. Protective series resistor a 1KΩ each consisting of a charge period of 30 ± 5 seconds, followed by discharge period of approximately 5.5 minutes. Applying voltage:	Capacitance change	Within ± 20% of initial value
			Tanδ	Less than 175% of specified value
			Leakage Current	Within specified value
			Physical	No broken and undamaged

Rated Voltage(V)	10	16	25	35	50	63	400
Surge Voltage(V)	11.5	18.4	28.8	40.3	57.5	72.5	440

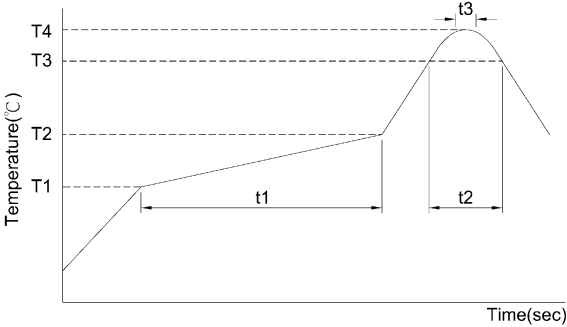
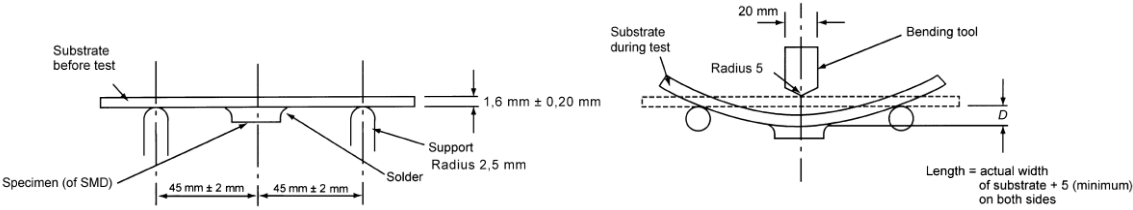

No.	Item	Conditions	Specification																																									
8	Solder Heat-Resistance Test	<p>1. IR Reflow</p>  <table border="1" data-bbox="427 560 914 920"> <tr> <td colspan="2">Rated voltage (V)</td> <td>10 ~ 35</td> <td>10 ~ 63</td> </tr> <tr> <td colspan="2">Case size (φ)</td> <td>3 ~ 6.3</td> <td>8 ~ 18</td> </tr> <tr> <td rowspan="2">Preheat</td> <td>Temp. (T1 ~ T2, °C)</td> <td colspan="2">150 ~ 180</td> </tr> <tr> <td>Time (t1) (max., secs)</td> <td colspan="2">100</td> </tr> <tr> <td rowspan="2">Duration</td> <td>Temp. (T3, °C)</td> <td>217</td> <td>230</td> </tr> <tr> <td>Time (t2) (max., secs)</td> <td>90</td> <td>60</td> </tr> <tr> <td rowspan="2">Peak</td> <td>Temp. (T4, °C)</td> <td>260</td> <td>250</td> </tr> <tr> <td>Time (t3, secs)</td> <td colspan="2">5</td> </tr> <tr> <td colspan="2">Reflow cycles</td> <td colspan="2">2 or less</td> </tr> </table> <p>2. Solder iron method:                      Bit temperature: 350 ± 5°C                      Application time of soldering Iron: 3 +1 / -0 sec                      * Please contact our representative if your condition is higher.                      * Please ensure that the capacitor became cold enough to the room temperature (5°C ~ 35°C) before the second reflow.                      * Consult with us when performing reflow profile in IPC / JEDEC (J-STD-020)</p>	Rated voltage (V)		10 ~ 35	10 ~ 63	Case size (φ)		3 ~ 6.3	8 ~ 18	Preheat	Temp. (T1 ~ T2, °C)	150 ~ 180		Time (t1) (max., secs)	100		Duration	Temp. (T3, °C)	217	230	Time (t2) (max., secs)	90	60	Peak	Temp. (T4, °C)	260	250	Time (t3, secs)	5		Reflow cycles		2 or less		<table border="1"> <tr> <td>Capacitance change</td> <td>Within ± 10% of initial value</td> </tr> <tr> <td>Tanδ</td> <td>Within specified value</td> </tr> <tr> <td>Leakage Current</td> <td>Within specified value</td> </tr> <tr> <td>Physical</td> <td>No broken and undamaged</td> </tr> </table>	Capacitance change	Within ± 10% of initial value	Tanδ	Within specified value	Leakage Current	Within specified value	Physical	No broken and undamaged
Rated voltage (V)		10 ~ 35	10 ~ 63																																									
Case size (φ)		3 ~ 6.3	8 ~ 18																																									
Preheat	Temp. (T1 ~ T2, °C)	150 ~ 180																																										
	Time (t1) (max., secs)	100																																										
Duration	Temp. (T3, °C)	217	230																																									
	Time (t2) (max., secs)	90	60																																									
Peak	Temp. (T4, °C)	260	250																																									
	Time (t3, secs)	5																																										
Reflow cycles		2 or less																																										
Capacitance change	Within ± 10% of initial value																																											
Tanδ	Within specified value																																											
Leakage Current	Within specified value																																											
Physical	No broken and undamaged																																											
9	Mechanical Characteristics Test	<p>Bending Test:                      Apply pressure in the direction of the arrow at a rate of about 0.5 mm / s until bent width reaches 2 mm and hold for 60s. The board shall be the test board "B" as specified in JIS C 0051: 2002. If the land area differs, it shall be specified clearly in the next item.</p> 	<p>Without mechanical damage such as breaks. Electrical characteristics shall be satisfied. If there are electrodes on both surfaces, above requirements shall be satisfied on whichever surface it may be fixated on.</p>																																									
10	Solderability Test	<p>After the lead wire fully immersed in the solder for 2 ± 0.5 secs at a temperature of 245 ± 5°C, the solder the solder coating must be more than 95%.</p>																																										
11	Venting Test	<p>1. Applicable to the capacitors with case size is 8×10 mm and larger.                      2. Test condition:                      (1) AC test: The capacitor shall be connected across an applying 50 or 60 Hz AC which is 0.7 times of rated voltage or 250Vrms AC whichever is the lower.                      (2) DC test: Applying inverse DC rated voltage with current to the capacitor.                      Where case diameter: φ D ≤ 22.4 mm: 1 A DC max.                      φ D &gt; 22.4 mm: 10 A DC max.</p> <p>Note:                      (1) When the pressure relief vent operated, the capacitor shall avoid any danger of fire or explosion of capacitor element (terminal and metal foil etc.) or cover.                      (2) When the pressure relief device does not open with the voltage applied over 30 minutes, the test is considered to be passed.</p>																																										

No.	Item	Conditions																																														
12	Land Pattern	<p data-bbox="347 188 742 215">Recommended pad pattern and size</p>  <table border="1" data-bbox="794 237 1449 421"> <thead> <tr> <th rowspan="2">Case size</th> <th colspan="3">Land size</th> <th rowspan="2">Case size</th> <th colspan="3">Land size</th> </tr> <tr> <th>G</th> <th>Y</th> <th>X</th> <th>G</th> <th>Y</th> <th>X</th> </tr> </thead> <tbody> <tr> <td>5φ</td> <td>1.4</td> <td>3.0</td> <td>1.6</td> <td>10φ</td> <td>4.0</td> <td>4.0</td> <td>2.5</td> </tr> <tr> <td>6.3φ</td> <td>1.9</td> <td>3.5</td> <td>1.6</td> <td>12.5φ</td> <td>4.0</td> <td>6.0</td> <td>3.2</td> </tr> <tr> <td>8φ x6.5L</td> <td>2.1</td> <td>4.0</td> <td>1.6</td> <td>16φ</td> <td>6.0</td> <td>7.0</td> <td>3.2</td> </tr> <tr> <td>8φ</td> <td>3.0</td> <td>3.5</td> <td>2.5</td> <td>18φ</td> <td>6.0</td> <td>8.0</td> <td>3.2</td> </tr> </tbody> </table>	Case size	Land size			Case size	Land size			G	Y	X	G	Y	X	5φ	1.4	3.0	1.6	10φ	4.0	4.0	2.5	6.3φ	1.9	3.5	1.6	12.5φ	4.0	6.0	3.2	8φ x6.5L	2.1	4.0	1.6	16φ	6.0	7.0	3.2	8φ	3.0	3.5	2.5	18φ	6.0	8.0	3.2
Case size	Land size			Case size	Land size																																											
	G	Y	X		G	Y	X																																									
5φ	1.4	3.0	1.6	10φ	4.0	4.0	2.5																																									
6.3φ	1.9	3.5	1.6	12.5φ	4.0	6.0	3.2																																									
8φ x6.5L	2.1	4.0	1.6	16φ	6.0	7.0	3.2																																									
8φ	3.0	3.5	2.5	18φ	6.0	8.0	3.2																																									
13	Standards	Satisfies Characteristic JIS C 5101-1, -18																																														

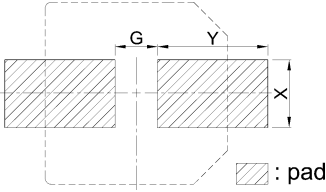
## Precautions and Guidelines for Aluminum Electrolytic Capacitors

### 1. Guidelines for Circuit Design (General / Application guidelines for using electrolytic capacitors)

**Selecting of a right capacitor is a key to a good circuit design.**

#### (1) Polarity

Most of the aluminum electrolytic capacitors are polarized. Therefore, they must be installed with the correct polarity. Usage in the reverse polarity results into a short-circuit condition that may damage or even explode the capacitor. In addition, it may influence circuit functionality. A bi-polar electrolytic capacitor should be installed when polarity across a capacitor is unstable / reversible. It should be, however, noted that usage of both polar and bi-polar capacitors are limited to DC applications. They must NOT be used for AC application.

#### (2) Operating Voltage

Applied DC voltage must not exceed rated voltage of the capacitor. Applying higher voltage than its rated voltage across a capacitor terminals cause overheating due to higher leakage currents and capacitor dielectric/insulation deterioration that will ultimately affect a capacitor's performance. The device, however, is capable of working under short-time transient voltages such as DC transients and peak AC ripples. Reverse voltages higher than 1 Volt within a specified temperature limit or AC voltages are not permissible. Overall, using capacitors at recommended operating voltages can prolong its lifespan. Note that the result of DC voltage overlapped with peak ripple voltage should not exceed rated voltage.

#### (3) Ripple Current

One of the key functions of any capacitor is removal of the ripple current i.e. the RMS value of AC flowing through a capacitor. But, a ripple current higher than rated ripple current will drop resultant capacitance, cause undue internal heating and thus reduces life span of the capacitor. In extreme cases, internal high temperature will cause the pressure relief vent to operate while destroying the device. Overall, it is important to note that an electrolytic capacitor must be used within a permissible range of ripple current. Indicators like temperature coefficient of allowable ripple current are generally used to determine life expectancy of the capacitor, but to avoid related complex calculations and for the sake of simplicity, we haven't provided temperature coefficient in the catalogue. But it offers key indicators like maximum operating temperature for calculation of life expectancy at a given temperature.

#### (4) Operating Temperature

Capacitors should be used within a permissible range of operating temperatures. Using capacitor at a higher temperature than maximum rated temperature will considerably shorten its life. In the worst-case scenario, high temperature can cause pressure relief vent to operate and the device will get destroyed. Using capacitors at an ambient room temperature assure their longer life.

#### (5) Leakage Current

Leakage current flows through a capacitor when DC voltage is applied across it. Leakage current varies with changes in ambient temperature and applied DC voltage level and its time of application. Overvoltage situation, presence of moisture, and thermal stresses, especially occurring during the soldering process can enhance leakage current. Initial leakage current is usually higher and does not decrease until voltage is applied for a certain period of time. It is recommended to keep initial leakage current within specified levels.

#### (6) Charge and Discharge

Regular electrolytic capacitors are not suitable for rapid charging/discharging circuits. Such usage may either cause reduction in overall capacitance or damage due to overheating. Lelon provides special assistance for selecting appropriate capacitors for rapid charging/discharging circuits.

#### (7) Surge Voltage

The Surge voltage rating is referred as the maximum DC overvoltage that may be applied to an electrolytic capacitor for a short time interval of 30 seconds at infrequent time intervals not exceeding 5.5minutes with a limiting resistance of 1k $\Omega$ . Unless otherwise described on the catalogue or product specifications, please do not apply a voltage exceeding the capacitor's voltage rating. The rated surge voltages corresponding to rated voltages of electrolytic capacitors are presented as follows:

Rated Voltage(V)	4	6.3	10	16	25	35	50
Surge Voltage(V)	4.6	7.3	11.5	18.4	28.8	40.3	57.5

Rated Voltage(V)	63	80	100	160	200	250	315
Surge Voltage(V)	72.5	92	115	184	230	288	347

Rated Voltage(V)	350	400	420	450	500	525
Surge Voltage(V)	385	440	462	495	550	578

#### (8) Condition of Use

The capacitors shall NOT be exposed to:

- Fluids including water, saltwater spray, oil, fumes, highly humid or condensed climates, etc.
- Ambient conditions containing hazardous gases/fumes like hydrogen sulfide, sulfurous acid, nitrous acid, chlorine or bromine gas, ammonia, etc.
- Exposed to ozone, ultraviolet rays and radiation.
- Severe vibrations or physical shocks that exceeds the specifications mentioned in this catalogue.

#### (9) Circuit Design Consideration

- Please ensure whether application, operating and mounting conditions satisfy the conditions specified in the catalog before installation of a capacitor. Please consult Lelon, if any of the conditions are beyond the conditions specified in the catalog.
- Heat-generating components or heat sinks should not be placed closer to Aluminum electrolytic capacitors on the PCB to avoid their premature failure. A cooling system is recommended to improve their reliable working.
- Electrical characteristics and performance of aluminum electrolytic capacitors are affected by variation of applied voltage, ripple current, ripple frequency and operating temperature. Therefore, these parameters shall not exceed specified values in the catalog.
- Aluminum capacitors may be connected in the parallel fashion for increasing total capacitance and/or for achieving higher ripple current capability. But, such design may cause unequal current flow through each of the capacitors due to differences in their impedances.
- When two or more capacitors are connected in series, voltage across each capacitor may differ and fall below the applied voltage. A resistor should be placed across each capacitor so as to match applied voltage with voltage across a capacitor.
- Please consult Lelon while selecting a capacitor for high-frequency switching circuit or a circuit that undergoes rapid charging/ discharging
- Standard outer sleeve of the capacitor is not a perfect electrical insulator therefore is unsuitable for the applications that requires perfect electrical insulation. Please consult Lelon, if your application requires perfect electrical insulation.
- Tilting or twisting capacitor body is not recommended once it is soldered to the PCB.

## 2. Caution for Assembling Capacitors

#### (1) Mounting

- Aluminum electrolytic capacitors are not recommended to re-use in other circuits once they are mounted and powered in a circuit.

- (b) Aluminum electrolytic capacitors may hold static charge between its anode and cathode, which is recommended to be discharged through a 1kΩ resistor before re-use.
- (c) A long storage of capacitors may result into its insulation deterioration. This can lead to a high leakage current when voltage is applied that may damage the capacitor. Capacitors following a long storage period must undergo voltage treatment/re-forming.  
Capacitors are charged by applying rated DC voltage through a resistor of 1kΩ in series at least for an hour. It is recommended to increase applied voltage gradually using a voltage regulator unit once capacitors are assembled on the board. The charging should be followed by discharging through a 1KΩ resistor.
- (d) Please check capacitor rated voltage before mounting.
- (e) Please check capacitor polarity before mounting.
- (f) Please don't drop capacitor on the floor / hard object.
- (g) Please don't deform the capacitor during installation.
- (h) Please confirm whether the lead spacing of the capacitors match with its pad spacing / footprint on PCB prior to installation.
- (i) Please avoid excessive mechanical shocks to capacitor during the auto-insertion process, inspection or centering operations.
- (j) Please don't place any wiring or circuit over the capacitor's pressure relief vent. The pressure relief vent may fail to open if adequate clearance space is not provided. Following table shows minimum clearance space required for different case diameters.

Case Diameter	φ 6.3 ~ φ 16	φ 18 ~ φ 35	φ 40 or above
Clearance (min)	2 mm	3 mm	5 mm

**(2) Soldering**

- (a) Please confirm that soldering conditions, especially temperature and contact time are within our specifications. Dip or flow soldering temperature should be limited at 260 ± 5°C for 10 ± 1 sec while manual soldering using soldering iron should be limited at 350 ± 5°C for 3 +1/-0 seconds. Please do not dip capacitor body into molten solder. A capacitor's life will be negatively affected if these conditions are violated.
- (b) Storage of capacitors in *high humidity* conditions is likely to affect the solder-ability of lead wires and terminals.

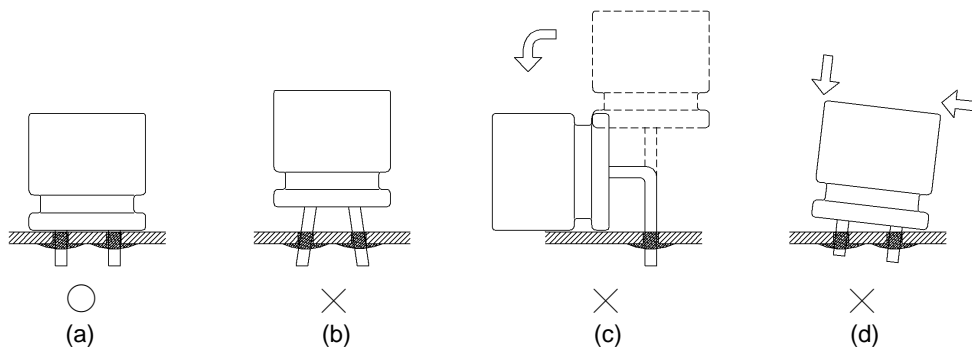

- (c) **Reflow soldering should NOLY be used for SMD type capacitors.** The temperature and duration shall not exceed the specified temperature and duration in the specification. If the temperature or duration is higher than the value specified, please consult Lelon before usage.
- (d) Standard aluminum electrolytic capacitors are not designed to withstand multiple reflow processes. Please consult Lelon if repeated reflowing is unavoidable.
- (e) Incorrect mounting on PCB with improper external strength applied on its lead wires or capacitor body after soldering may damage a capacitor's internal structure, cause short circuit, or lead to high leakage current issues. Do not bend or twist the capacitor body after soldering. Referring to the drawings below only case (i) is recommended.
  - (i) Correct soldering
  - (ii) Hole-to-hole spacing on PCB differs from the lead space of lead wires.
  - (iii) Lead wires are bent after soldering.
  - (iv) Capacitor body doesn't stand vertical on PCB after soldering.

**(3) Cleaning Circuit Boards after Soldering**

- (a) Following chemicals are not recommended for cleaning: Solvent containing halogen ions, Alkaline solvent, Xylene, Acetone, Terpene, petro-based solvent.
- (b) Recommended cleaning conditions: Fatty-alcohol - Pine Alpha ST-100S, Clean Through-750H and IPA (isopropyl alcohol) are examples of the most acceptable cleaning agents. Temperature of the cleaning agent must not exceed 60°C. Flux content in the cleaning agents should be limited to 2 Wt. %. Overall length of cleaning process (e.g., immersion, ultrasonic or other) shall be within 5 minutes (5 ~ 7mm height within 3 minutes). CFC substitute cleaning agents such as AK225AES can also be used for cleaning. In this case, its temperature shall not exceed 40 C and cleaning process (e.g., immersion, ultrasonic or other) shall be completed within 2 ~ 3 minutes. After cleaning capacitors should be dried with hot air for at least 10 minutes along with the PCB. Temperature of hot air shall not exceed maximum category temperature of the capacitor. Insufficient drying may cause appearance defects, sleeve shrinkage, and bottom-plate bulging. However, usage of this CFC substitute must completely regulated for protection of environment.

**3. Maintenance Inspection**

Periodical inspection of aluminum capacitors is absolutely necessary, especially when they are used with industrial equipment. The following items should be checked:

- (1) Appearance: Bloated, vent operated, leaked, etc.
- (2) Electrical characteristic: Capacitance, Tanδ, leakage current, and other specified items listed in specification.

Lelon recommend replacing the capacitors if any of the abovementioned items fail to meet specifications.

**4. Storage**

- (1) The most suitable conditions for aluminum capacitor storage are 5 °C ~ 35°C and indoor relative humidity less than 75%. High temperature and/or humidity storage is detrimental to the capacitors.
- (2) Capacitors shall not be stored in wet or damp atmospheres containing water, brine, fumes or oil.
- (3) Capacitors storage area shall neither be exposed to hazardous gases such as hydrogen sulfide, sulfurous acid, nitrous acid, chlorine, ammonium, etc. nor to acidic or alkaline solutions.
- (4) Capacitors shall not be exposed to ozone, ultraviolet rays or radiation.

## 5. Estimation of life time

$$L_r = L_0 \times 2^{\frac{T_{0\max} - T_{r\max}}{10}}$$

$L_r$ : Estimated lifetime (hours)

$L_0$ : Base lifetime specified at maximum operating temperature with applied the DC voltage and the ripple current (hours)

$T_{0\max}$ : The core temperature that rated ripple current applied at maximum operating temperature.

$T_{r\max}$ : The core temperature that applied actual ripple current at ambient temperature.

## 6. Disposal

Please consult with a local industrial waste disposal specialist when disposing of aluminum electrolytic capacitors.

## 7. Environmental Consideration

Lelon already have received ISO 14000 certificate. Cadmium (Cd), Lead (Pb), Mercury (Hg), Hexavalent Chromium (Cr<sup>+6</sup>), PBB, PBDE, DEHP, BBP, DBP and DIBP have never been using in capacitor. If you need "Halogen-free" products, please consult with us.

## 8. AEC-Q200 Compliance

Automotive Electronics Counsel (AEC) has established various electronic component qualification/reliability standards in order to serve automotive electronics industry. AEC-Q200 standard is dedicated for passive components like capacitors, inductors, etc. and is widely adopted domestically as well as internationally. Lelon offers compliant product designs and support services to satisfy customers' product requirements, including the AEC-Q200 required criteria of the reliability tests. Lelon's capacitors are professionally designed to outperform all requirements of AEC-Q200.

For further details, please refer to

IEC 60384-4- Fixed capacitors for use in electronic equipment – Part 4: Sectional specification – Aluminium electrolytic capacitors with solid (MnO<sub>2</sub>) and non-solid electrolyte (Established in January 1995, Revised in March 2007), and

EIAJ RCR-2367B- Guideline of notabilia for fixed aluminium electrolytic capacitors for use in electronic equipment [Technical Standardization Committee on Passive Components (Established in March 1995, Revised in March 2002)].