



Is Now Part of



ON Semiconductor®

To learn more about ON Semiconductor, please visit our website at
www.onsemi.com

Please note: As part of the Fairchild Semiconductor integration, some of the Fairchild orderable part numbers will need to change in order to meet ON Semiconductor's system requirements. Since the ON Semiconductor product management systems do not have the ability to manage part nomenclature that utilizes an underscore (_), the underscore (_) in the Fairchild part numbers will be changed to a dash (-). This document may contain device numbers with an underscore (_). Please check the ON Semiconductor website to verify the updated device numbers. The most current and up-to-date ordering information can be found at www.onsemi.com. Please email any questions regarding the system integration to Fairchild_questions@onsemi.com.

ON Semiconductor and the ON Semiconductor logo are trademarks of Semiconductor Components Industries, LLC dba ON Semiconductor or its subsidiaries in the United States and/or other countries. ON Semiconductor owns the rights to a number of patents, trademarks, copyrights, trade secrets, and other intellectual property. A listing of ON Semiconductor's product/patent coverage may be accessed at www.onsemi.com/site/pdf/Patent-Marking.pdf. ON Semiconductor reserves the right to make changes without further notice to any products herein. ON Semiconductor makes no warranty, representation or guarantee regarding the suitability of its products for any particular purpose, nor does ON Semiconductor assume any liability arising out of the application or use of any product or circuit, and specifically disclaims any and all liability, including without limitation special, consequential or incidental damages. Buyer is responsible for its products and applications using ON Semiconductor products, including compliance with all laws, regulations and safety requirements or standards, regardless of any support or applications information provided by ON Semiconductor. "Typical" parameters which may be provided in ON Semiconductor data sheets and/or specifications can and do vary in different applications and actual performance may vary over time. All operating parameters, including "Typicals" must be validated for each customer application by customer's technical experts. ON Semiconductor does not convey any license under its patent rights nor the rights of others. ON Semiconductor products are not designed, intended, or authorized for use as a critical component in life support systems or any FDA Class 3 medical devices or medical devices with a same or similar classification in a foreign jurisdiction or any devices intended for implantation in the human body. Should Buyer purchase or use ON Semiconductor products for any such unintended or unauthorized application, Buyer shall indemnify and hold ON Semiconductor and its officers, employees, subsidiaries, affiliates, and distributors harmless against all claims, costs, damages, and expenses, and reasonable attorney fees arising out of, directly or indirectly, any claim of personal injury or death associated with such unintended or unauthorized use, even if such claim alleges that ON Semiconductor was negligent regarding the design or manufacture of the part. ON Semiconductor is an Equal Opportunity/Affirmative Action Employer. This literature is subject to all applicable copyright laws and is not for resale in any manner.



FAN4149 Ground Fault Interrupter

Features

- Meets 2015 UL943 Self-Test Requirements (*in combination with FAN41501*)
- Precision Sense Amplifier and Bandgap Reference
- Low- V_{OS} Offset for Direct DC Coupling of Sense Coil
- Built-in Noise Filter
- High-Current SCR Gate Driver
- Adjustable Sensitivity
- 500 μ A Quiescent Current
- Minimum External Components
- Ideal for 120 V or 220 V Systems
- Space-Saving, SOT23, 6-Pin Package

Applications

- GFCI Output Receptacle
- GFCI Circuit Breakers
- Portable GFCI Cords
- Residual-Current Devices (RCD)

Description

The FAN4149 is a low-power controller for detecting hazardous current paths to ground and ground-to-neutral faults. The FAN4149 application circuit opens the load contacts before a harmful shock occurs.

The FAN4149, in combination with the FAN41501 auto-monitoring digital controller, meets the 2015 UL943 self-test requirements for permanently connected GFCI products. The FAN4149 detects and protects against a hot-wire-to-ground fault and a neutral-to-line/load short. The FAN41501 periodically monitors the FAN4149 and critical GFI components to comply with the 2015 UL943 requirements. The minimum number of components and the small 6-pin package allow for a dense, flexible, application solution.

The FAN4149 contains a precision bandgap 14 V shunt regulator, precision low- V_{OS} sense amplifier, time-delay noise filter, window-detection comparators, and an SCR driver. The shunt regulator operates with a low quiescent current, which allows for a high value, low-wattage series supply resistor. The internal temperature compensated shunt regulator, sense amplifier, and bias circuitry provide for precision ground-fault detection. This enables the use of larger component variations so that binning or trimming external components is not required. The typical $\pm 50 \mu$ V V_{OS} sense amplifier offset allows for direct DC coupling of the sense coil. This eliminates the large AC-coupling capacitor. The internal delay filter rejects high-frequency noise spikes common with inductive loads. This decreases false nuisance tripping. The SCR driver provides increased current and temperature compensation to allow for a wider selection of external SCRs.

The minimum number of external components and the 6-pin SOT23 package allow a low-cost, compact design and layout.

Ordering Information

Part Number	Operating Temperature Range	Package	Packing Method
FAN4149M6X	-35°C to +85°C	6-Lead, SOT23, JEDEC M0-178, 1.6 mm	Tape and Reel

Block Diagram

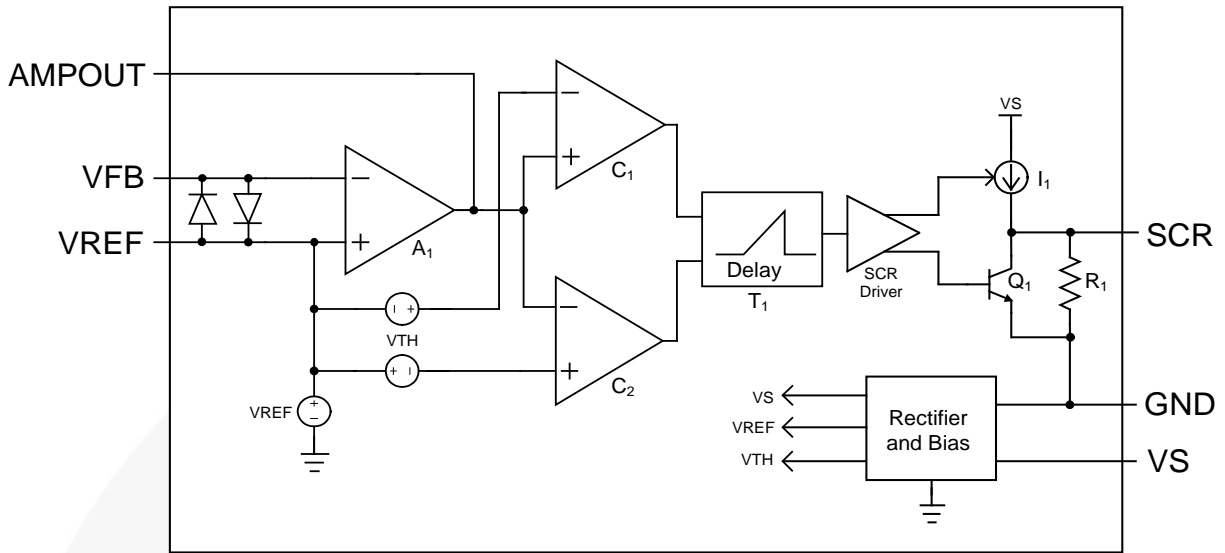

Figure 1. Block Diagram

Typical Application

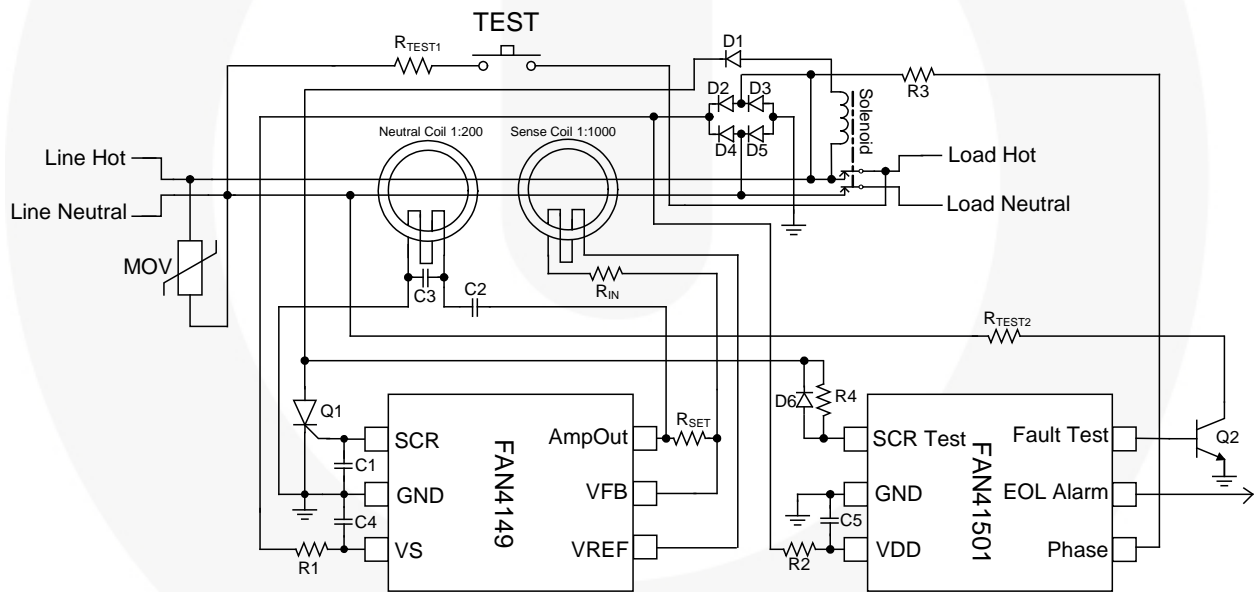

Figure 2. Typical Application^(1,2)

Table 1. Typical Values

R1: 75 kΩ	R _{IN} : 470 Ω	R _{TEST1} : 15 kΩ	R _{TEST2} : 10 kΩ	R _{SET} : 750 kΩ ⁽³⁾
R2: 75 kΩ	R3: 1 MΩ	R4: 909 kΩ	C1: 22 nF	C2: 10 nF
C3: 5.6 nF	C4: 220 nF	C5: 1 μF		

XMFR: Magnetic Metals 5029/F3006

Notes:

1. Contact Fairchild for self-test requirement details.
2. Portions of this schematic are subject to U.S. patents 8,085,516 and 8,760,824.
3. Value depends on sense-coil characteristics and application.

Pin Configuration

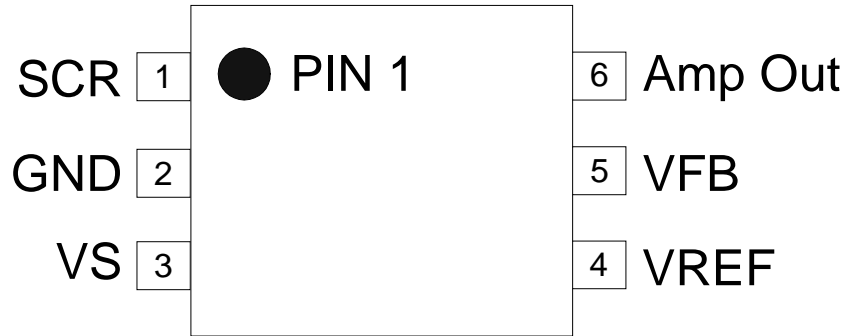

Figure 3. Pin Configuration

Pin Definitions

Pin #	Name	Description
1	SCR	Gate drive for external SCR
2	GND	Supply input for FAN4149 circuitry
3	VS	Supply input for FAN4149 circuitry
4	VREF	Non-inverting input for current sense amplifier
5	VFB	Inverting input for current sense amplifier
6	Amp Out	An external resistor connected to VFB sets the I_{FAULT} sensitivity threshold

Absolute Maximum Ratings

Stresses exceeding the absolute maximum ratings may damage the device. The device may not function or be operable above the recommended operating conditions and stressing the parts to these levels is not recommended. In addition, extended exposure to stresses above the recommended operating conditions may affect device reliability. The absolute maximum ratings are stress ratings only.

Symbol	Parameter	Condition	Min.	Max.	Unit
I _{CC}	Supply Current	Continuous Current, VS to GND		15	mA
V _{CC}	Supply Voltage	Continuous Voltage to GND, All Pins	-0.8	16.0	V
T _{STG}	Storage Temperature Range		-65	+150	°C
ESD	Electrostatic Discharge Capability	Human Body Model, ANSI/ESDA/JEDEC JS-001-2012		2.5	kV
		Charged Device Model, JESD22-C101		1.0	

DC Electrical Characteristics

Unless otherwise specified, T_A=25°C, I_{shunt}=1 mA, and referencing Figure 2.

Symbol	Parameter	Conditions	Min.	Typ.	Max.	Unit
V _{REG}	Power Supply Shunt Regulator Voltage	VS to GND	13.7	14.0	14.3	V
I _Q	Quiescent Current	Line to GND=10 V	425	500	575	μA
V _{REF}	Reference Voltage	V _{REF} to GND	6.85	7.00	7.15	V
V _{TH}	Trip Threshold	Amp Out to VREF	4.35	4.50	4.65	V
V _{OS}	Amplifier Offset	Gain=1000	-175	±50	175	μV
	Amplifier Offset Drift ⁽⁴⁾	Gain=1000	-100		100	μV
I _{OS}	Amplifier Input Offset ⁽⁵⁾	Design Value	-50	0	50	nA
G	Amplifier DC Gain ⁽⁵⁾	Design Value		100		dB
f _{GBW}	Amplifier Gain Bandwidth ⁽⁵⁾	Design Value		3		MHz
V _{SW+}	Amplifier Positive Voltage Swing	Amp Out to VREF, I _{FAULT} =10 μA	5.5			V
V _{SW-}	Amplifier Negative Voltage Swing	VREF to Amp Out, I _{FAULT} =-10 μA	5.5			V
I _{SINK}	Amplifier Current Sink	Amp Out=VREF + 3 V, V _{FB} =VREF + 100 mV	400			μA
I _{SRL}	Amplifier Current Source	Amp Out=VREF - 3 V, V _{FB} =VREF - 100 mV	400			μA
t _d	Delay Filter	Delay from C ₁ Trip to SCR L->H	0.65	1.00	1.35	ms
R _{OUT}	SCR Output Resistance	SCR to GND=250 mV, Amp Out=VREF		0.5	1.0	kΩ
V _{OUT}	SCR Output Voltage	SCR to GND, Amp Out=VREF		1	10	mV
	SCR Output Voltage	SCR to GND, AMP Out=VREF + 4 V	3.0			V
I _{OUT}	SCR Output Current	SCR to GND=1 V Amp Out=VREF + 4 V, I _{SHUNT} =2 mA	650	725		μA

Notes:

- Maximum V_{OS} offset temperature cycling drift from initial value (JEDEC JESD22-A104).
- Guaranteed by design, not tested in production.

Functional Description

Refer to Figure 2.

The FAN4149 is a GFCI controller for AC ground-fault circuit interrupters. The low- V_{OS} offset for the sense amplifier allows for direct DC coupling of the sense coil when the FAN4149 is biased with a full-wave diode bridge. This allows for the FAN4149 to be used with the FAN41501 digital auto-monitoring controller to provide for a low-BOM-cost, complete, GFI solution with self testing for the critical GFCI components.

The internal shunt regulator rectifier circuit is supplied from the full-wave rectifier bridge and 75 k Ω series resistor. A typical 220 nF V_S bypass capacitor is used to filter the V_{AC} ripple voltage. The internal 14 V shunt regulator uses a precision temperature-compensated bandgap reference. The combination of precision reference circuitry and precision sense amplifier provides for an accurate ground-fault tolerance. This allows for selection of external components with wider and lower-cost parameter variations. Due to the low quiescent current, a high-value external series resistor (R_1) can be used to reduce the maximum power wattage required for this resistor. The 14 V shunt regulator generates the V_{REF} reference voltage for the sense amplifier's (A_1) non-inverting input (AC ground reference). It also supplies the bias for the delay timer (t_1), comparators (C_1 & C_2), and the SCR driver.

The secondary winding of the sense transformer is connected to pin 4 (V_{REF}) and to a resistor, R_{IN} , which is directly DC connected to the inverting input of the sense amplifier at pin 5 (V_{FB}). The feedback resistor (R_{SET}) converts the sense transformer's secondary current to a voltage at pin 6 (Amp Out). This voltage is compared to the internal window comparator (C_1 & C_2). When the Amp Out voltage exceeds the $\pm V_{TH}$ threshold voltage, the window comparator triggers the internal delay timer. The output of the window comparator must stay HIGH for the duration of the t_1 timer. If the window comparator's output goes LOW, the internal delay timer starts a reset cycle. If the window comparator's output is still HIGH at the end of the t_1 pulse, the SCR driver enables current source I_1 and disables Q1. Current source I_1 then enables the external SCR; which energizes the solenoid, opens the contact switches to the load, and removes the hazardous ground fault. The window comparator allows for detection of a positive or negative I_{FAULT} signal, independent from the phase of the line voltage.

Calculation of R_{SET} Resistor

The Amp Out signal must exceed the window comparator's V_{TH} threshold voltage for longer than the delay timer and calculated by:

$$V_{TH} = I_{FAULT} \times 1.22 \times R_{SET} \times \cos(2\pi \times (t/2P)) / N \quad (1)$$

$$R_{SET} = (V_{TH} \times N) / (1.22 \times I_{FAULT} \times \cos(\pi \times t/P)) \quad (2)$$

where:

$$V_{TH} = 4.5 \text{ V}$$

$$I_{FAULT} = 5 \text{ mA}_{RMS} \text{ (UL943)}$$

$$T = 1 \text{ ms (timer delay)}$$

$$P = \text{Period of the AC Line (1/60 Hz)}$$

$$P = \text{Period of the AC Line (1/60 Hz)}$$

$$N = \text{Ratio of secondary-to-primary turns (1000:1)}$$

$$R_{SET} = 750 \text{ k}\Omega \text{ (standard 1\% value)}$$

In practice, the transformer is non-ideal, so R_{SET} may need to be adjusted by up to 30% to obtain the desired I_{FAULT} trip threshold.

Calculation of V_{OS} Trip Threshold Error

Since the sense coil is directly connected to the feedback of the sense amplifier, the V_{OS} offset introduces an I_{FAULT} threshold error. This error can be calculated as follows:

$$\%Error = 100 \times (V_{OS} \times R_{SET}) / (R_{IN} + R_{LDC}) / V_{TH} \quad (3)$$

where:

$$V_{OS} = \begin{matrix} \pm 175 \mu\text{V (worst case)} \\ \pm 50 \mu\text{V (typical)} \end{matrix}$$

$$R_{SET} = 750 \text{ k}\Omega$$

$$R_{IN} = 470 \Omega \text{ (typical value)}$$

$$R_{LDC} = 75 \Omega \text{ (sense coil secondary DC resistance)}$$

$$V_{TH} = 4.5 \text{ V}$$

$$\%Error = \begin{matrix} \pm 5.4\% \text{ (worst case)} \\ \pm 1.5\% \text{ (typical)} \end{matrix}$$

The $V_{OS} \pm 100 \mu\text{V}$ maximum drift specification is based on temperature cycling per JEDEC JESD22-A104, Condition B, 850 temperature cycles at -55°C to $+125^\circ\text{C}$.

Grounded Neutral Detection

If the neutral load terminal side is incorrectly connected to the earth ground, the sense coil does not correctly detect the hazardous ground fault current from "load hot" to earth ground due to the partial I_{FAULT} current flowing from the grounded neutral fault (load neutral) to earth ground.

To detect a grounded neutral fault, a grounded neutral coil is required. When a low resistive path occurs from the line neutral and load neutral terminals, the sense and neutral coils are mutually coupled. The mutual coupling produces a positive feedback path around the sense amplifier, which causes the sense amplifier to oscillate. When the peak oscillation voltage exceeds the SCR trigger threshold, the internal delay timer is enabled. Since the amplifier's output signal is crossing the window comparator's trip threshold typically at 6 kHz, the delay timer alternates between detection of a fault/no-fault. The ratio of the fault/no-fault detection time interval determines if the SCR driver is enabled.

The sensitivity of the grounded neutral detection can be changed by the neutral coil turns and the value of C_2 and C_3 .

GFCI Self Test Requirement

Starting in June of 2015, UL943 requires all permanently connected GFCI products to perform a self-test function. By adding Fairchild's FAN41501 product to the FAN4149 application (see *Figure 2*), a fully compliant 2015 UL943 self-test function can be achieved with two, small, independent, 6-pin, 1.6 mm-wide devices and a minimum number of external components. The 2015 UL code requires that, at power up, the GFCI self test the critical GFCI components --

FAN4149, SCR, sense coil, and solenoid -- within five seconds and thereafter within every three hours. The self-test cycle cannot open the load contacts. If a component failure is detected, the load power must be denied. Refer to the [FAN41501](#) datasheet for more details about the UL943 self-test features.



Typical Performance Characteristics

Unless otherwise specified, $T_A=25^\circ\text{C}$ and according to Figure 2 with SCR disconnected.

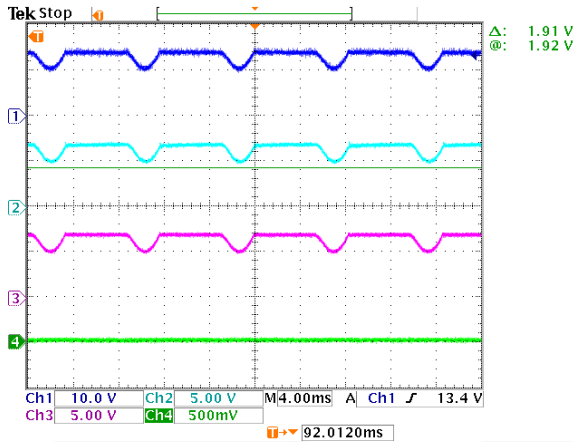

Ch1: VS (Pin 3), 10 V/Div
 Ch2: AmpOut (Pin 6), 5 V/Div
 Ch3: VREF (Pin 4), 5 V/Div
 Ch4: SCR (Pin 1), 500 mV/Div

Figure 4. Typical Waveforms, No Ground Fault

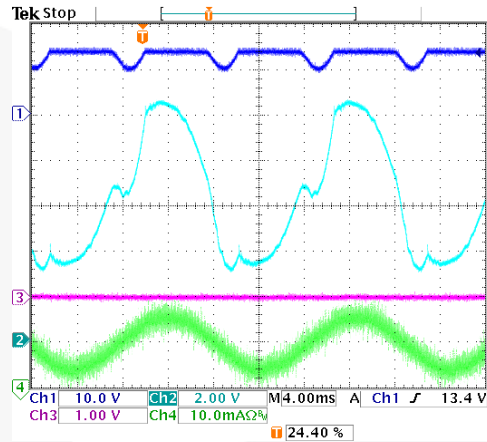

Ch1: VS (Pin 3), 10 V/Div
 Ch2: AmpOut (Pin 6), 2 V/Div
 Ch3: SCR (Pin 1), 1 V/Div
 Ch4: I_{FAULT} , 10 mA/Div

Figure 5. Typical Waveforms, 4 mA Ground Fault

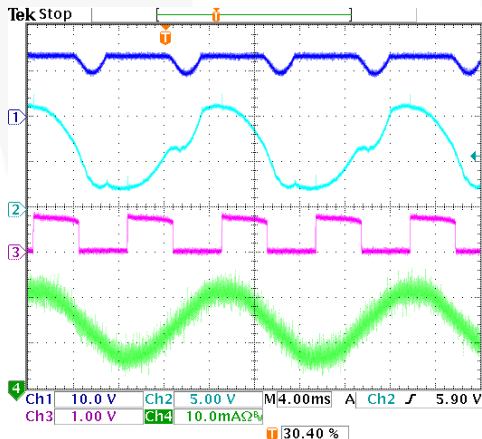

Ch1: VS (Pin 3), 10 V/Div
 Ch2: AmpOut (Pin 6), 5 V/Div
 Ch3: SCR (Pin 1), 1 V/Div
 Ch4: I_{FAULT} , 10 mA/Div

Figure 6. Typical Waveforms, 5 mA Ground Fault

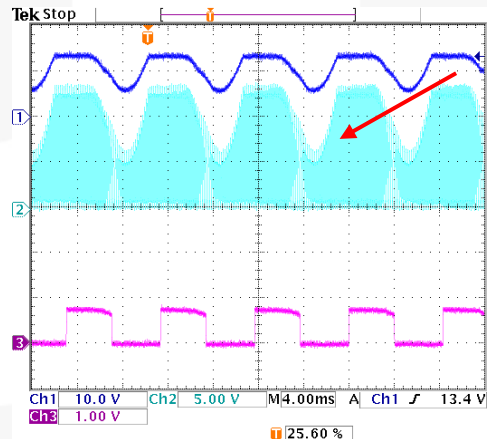

Ch1: VS (Pin 3), 10 V/Div
 Ch2: AmpOut (Pin 6), 5 V/Div
 Ch3: SCR (Pin 1), 1 V/Div

Figure 7. Typical Waveforms for Grounded Neutral Detection

Continued on the following page...

Typical Performance Characteristics (Continued)

Unless otherwise specified, $T_A=25^\circ\text{C}$ and according to Figure 1 with SCR disconnected.

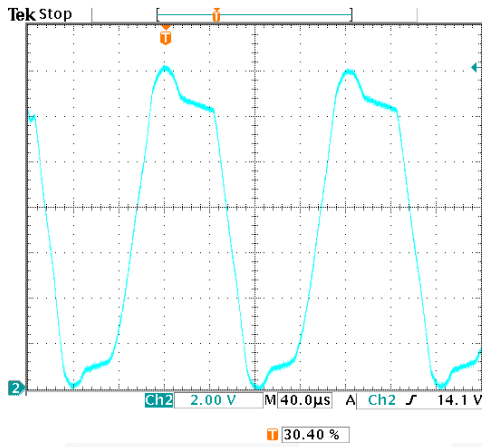

Ch2: AmpOut (Pin 6), 2 V/Div

Figure 8. Typical Waveform for Grounded Neutral Detection

Typical Temperature Characteristics

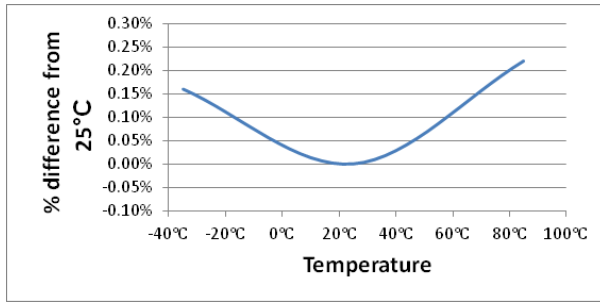

Figure 9. Shunt Regulator Voltage vs. Temperature

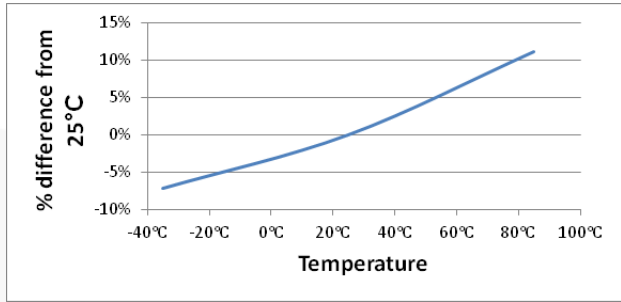

Figure 10. Quiescent Current vs. Temperature

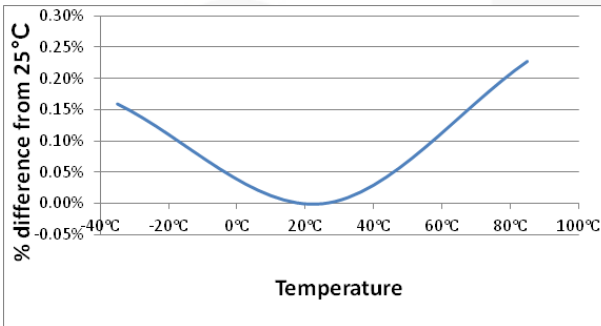

Figure 11. Reference Voltage vs. Temperature

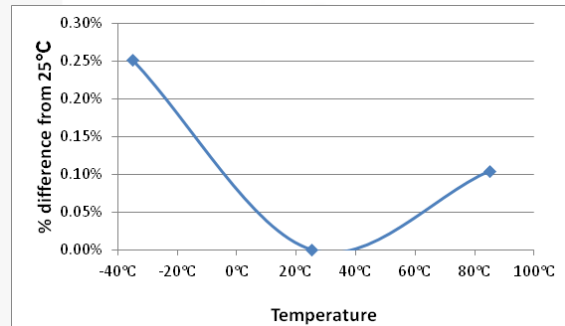

Figure 12. VH Threshold Voltage vs. Temperature

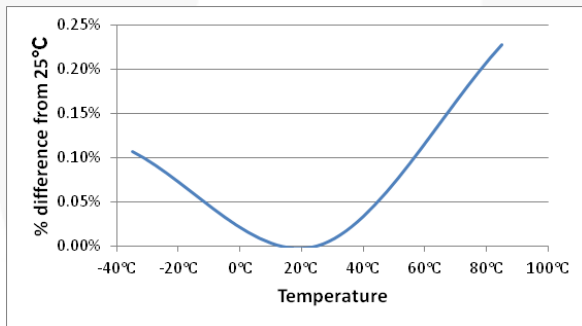

Figure 13. VL Threshold Voltage vs. Temperature

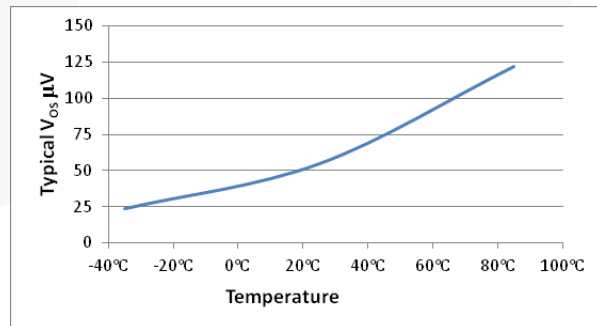

Figure 14. Typical Vos vs. Temperature

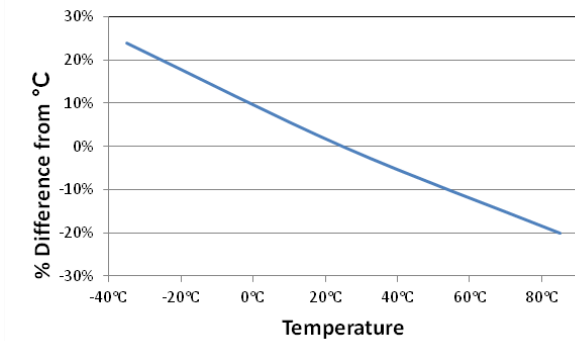

Figure 15. I_{OUT} SCR Out vs. Temperature

ON Semiconductor and  are trademarks of Semiconductor Components Industries, LLC dba ON Semiconductor or its subsidiaries in the United States and/or other countries. ON Semiconductor owns the rights to a number of patents, trademarks, copyrights, trade secrets, and other intellectual property. A listing of ON Semiconductor's product/patent coverage may be accessed at www.onsemi.com/site/pdf/Patent-Marking.pdf. ON Semiconductor reserves the right to make changes without further notice to any products herein. ON Semiconductor makes no warranty, representation or guarantee regarding the suitability of its products for any particular purpose, nor does ON Semiconductor assume any liability arising out of the application or use of any product or circuit, and specifically disclaims any and all liability, including without limitation special, consequential or incidental damages. Buyer is responsible for its products and applications using ON Semiconductor products, including compliance with all laws, regulations and safety requirements or standards, regardless of any support or applications information provided by ON Semiconductor. "Typical" parameters which may be provided in ON Semiconductor data sheets and/or specifications can and do vary in different applications and actual performance may vary over time. All operating parameters, including "Typicals" must be validated for each customer application by customer's technical experts. ON Semiconductor does not convey any license under its patent rights nor the rights of others. ON Semiconductor products are not designed, intended, or authorized for use as a critical component in life support systems or any FDA Class 3 medical devices or medical devices with a same or similar classification in a foreign jurisdiction or any devices intended for implantation in the human body. Should Buyer purchase or use ON Semiconductor products for any such unintended or unauthorized application, Buyer shall indemnify and hold ON Semiconductor and its officers, employees, subsidiaries, affiliates, and distributors harmless against all claims, costs, damages, and expenses, and reasonable attorney fees arising out of, directly or indirectly, any claim of personal injury or death associated with such unintended or unauthorized use, even if such claim alleges that ON Semiconductor was negligent regarding the design or manufacture of the part. ON Semiconductor is an Equal Opportunity/Affirmative Action Employer. This literature is subject to all applicable copyright laws and is not for resale in any manner.

PUBLICATION ORDERING INFORMATION

LITERATURE FULFILLMENT:

Literature Distribution Center for ON Semiconductor
19521 E. 32nd Pkwy, Aurora, Colorado 80011 USA
Phone: 303-675-2175 or 800-344-3860 Toll Free USA/Canada
Fax: 303-675-2176 or 800-344-3867 Toll Free USA/Canada
Email: orderlit@onsemi.com

N. American Technical Support: 800-282-9855 Toll Free
USA/Canada
Europe, Middle East and Africa Technical Support:
Phone: 421 33 790 2910
Japan Customer Focus Center
Phone: 81-3-5817-1050

ON Semiconductor Website: www.onsemi.com
Order Literature: <http://www.onsemi.com/orderlit>
For additional information, please contact your local
Sales Representative