

# LMT70、LMT70A $\pm 0.05^{\circ}\text{C}$ 精密模拟温度传感器、RTD 和精密 NTC 热敏电阻 IC

## 1 特性

- 精度:
  - $20^{\circ}\text{C}$  至  $42^{\circ}\text{C}$  范围内为  $\pm 0.05^{\circ}\text{C}$  (典型值) 或  $\pm 0.13^{\circ}\text{C}$  (最大值)
  - $-20^{\circ}\text{C}$  至  $90^{\circ}\text{C}$  范围内为  $\pm 0.2^{\circ}\text{C}$  (最大值)
  - $90^{\circ}\text{C}$  至  $110^{\circ}\text{C}$  范围内为  $\pm 0.23^{\circ}\text{C}$  (最大值)
  - $-55^{\circ}\text{C}$  至  $150^{\circ}\text{C}$  范围内为  $\pm 0.36^{\circ}\text{C}$  (最大值)
- 宽温度范围:  $-55^{\circ}\text{C}$  至  $150^{\circ}\text{C}$
- 卷带包装中相邻两个 LMT70A 的温度匹配:  $30^{\circ}\text{C}$  时为  $0.1^{\circ}\text{C}$  (最大值)
- 带有输出使能引脚的超线性模拟温度传感器
- 负温度系数 (NTC) 输出斜率:  $-5.19\text{mV}/^{\circ}\text{C}$
- $R_{\text{DS on}} < 80\Omega$  时输出开启/关闭开关
- 宽电源范围:  $2.0\text{V}$  至  $5.5\text{V}$
- 低电源电流:  $9.2\mu\text{A}$  (典型值)  $12\mu\text{A}$  (最大值)
- 超小型  $0.88\text{mm} \times 0.88\text{mm}$  4 凸点 WLCSP (DSBGA) 封装

## 2 应用

- 物联网 (IoT) 传感器节点
- 工业电阻式温度检测器 (RTD) (AA 类) 或精密 NTC/正温度系数 (PTC) 热敏电阻的替代产品
- 医疗/健身设备
- 医疗温度计
- 人体温度监视器
- 计量温度补偿

## 4 宽温度范围、精密、有源 RTD 或 NTC 的替代产品 ( $-55^{\circ}\text{C}$ 至 $150^{\circ}\text{C}$ )

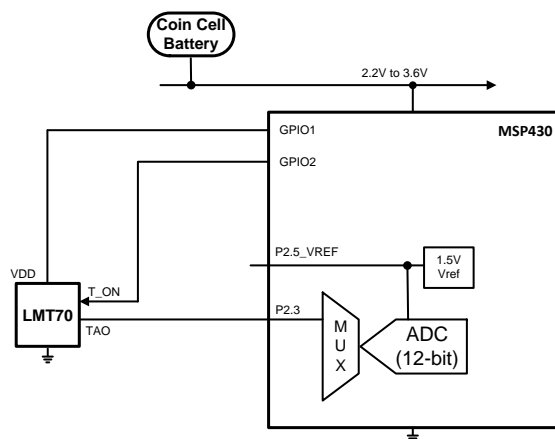

## 3 说明

LMT70 是一款带有输出使能引脚的超小型、高精度、低功耗互补金属氧化物半导体 (CMOS) 模拟温度传感器。LMT70 几乎适用于所有高精度、低功耗的经济高效型温度感测应用，例如物联网 (IoT) 传感器节点、医疗温度计、高精度仪器仪表和电池供电设备。LMT70 也是 RTD 和高精度 NTC/PTC 热敏电阻的理想替代产品。

多个 LMT70 可利用输出使能引脚来共用一个模数转换器 (ADC) 通道，从而简化 ADC 校准过程并降低精密温度感测系统的总成本。LMT70 还具有一个线性低阻抗输出，支持与现成的微控制器 (MCU)/ADC 无缝连接。LMT70 的热耗散低于  $36\mu\text{W}$ ，这种超低自发热特性支持其在宽温度范围内保持高精度。

LMT70A 具有出色的温度匹配性能，同一卷带中取出的相邻两个 LMT70A 的温度最多相差  $0.1^{\circ}\text{C}$ 。因此，对于需要计算热量传递的能量计量应用而言，LMT70A 是一套理想的解决方案。

器件信息 (1)

器件型号	封装	封装尺寸 (标称值)
LMT70	DSBGA - WLCSP (4) YFQ	$0.88\text{mm} \times 0.88\text{mm}$

(1) 要了解所有可用封装，请见数据表末尾的可订购产品附录。

LMT70 精度与温度间的关系

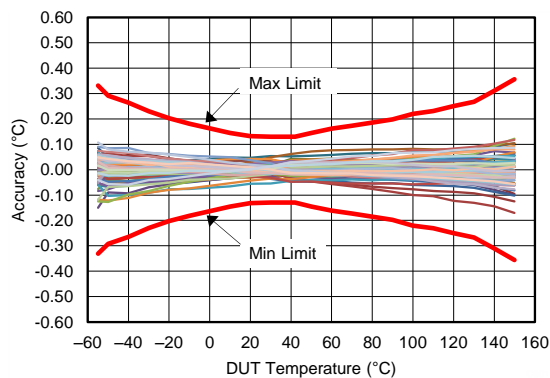

## 目录

1	特性 .....	1	9.2	Functional Block Diagram .....	11
2	应用 .....	1	9.3	Feature Description .....	11
3	说明 .....	1	9.4	Device Functional Modes .....	15
4	宽温度范围、精密、有源 RTD 或 NTC 的替代产品 (-55°C 至 150°C) .....	1	<b>10</b>	<b>Application and Implementation</b> .....	<b>16</b>
5	修订历史记录 .....	2	10.1	Application Information .....	16
6	<b>Device Comparison Table</b> .....	3	10.2	Typical Application .....	16
7	<b>Pin Configuration and Functions</b> .....	3	10.3	System Examples .....	21
8	<b>Specifications</b> .....	4	<b>11</b>	<b>Power Supply Recommendations</b> .....	<b>21</b>
8.1	Absolute Maximum Ratings .....	4	<b>12</b>	<b>Layout</b> .....	<b>22</b>
8.2	ESD Ratings .....	4	12.1	Layout Guidelines .....	22
8.3	Recommended Operating Conditions .....	4	12.2	Layout Example .....	22
8.4	Thermal Information .....	4	<b>13</b>	<b>器件和文档支持</b> .....	<b>23</b>
8.5	Electrical Characteristics .....	5	13.1	相关链接 .....	23
8.6	Electrical Characteristics Temperature Lookup Table (LUT) .....	6	13.2	文档支持 .....	23
8.7	Switching Characteristics .....	7	13.3	社区资源 .....	23
8.8	Typical Performance Characteristics .....	7	13.4	商标 .....	23
<b>9</b>	<b>Detailed Description</b> .....	<b>11</b>	13.5	静电放电警告 .....	23
9.1	Overview .....	11	13.6	Glossary .....	23
			<b>14</b>	<b>机械、封装和可订购信息</b> .....	<b>23</b>

## 5 修订历史记录

### Changes from Original (March 2015) to Revision A

**Page**

• 已添加 典型精度规范。 .....	1
• 已将 $\pm 0.2^{\circ}\text{C}$ 精度的温度范围从“ $20^{\circ}\text{C}$ 至 $90^{\circ}\text{C}$ ”扩展至“ $-20^{\circ}\text{C}$ 至 $90^{\circ}\text{C}$ ”。 .....	1
• 已添加 $9.2\mu\text{A}$ (典型值) .....	1
• Updated schematic .....	3
• Added $-20^{\circ}\text{C}$ accuracy specification .....	5
• Changed from $20^{\circ}\text{C}$ to $20^{\circ}\text{C}$ to $42^{\circ}\text{C}$ for accuracy specification condition .....	5
• Added $50^{\circ}\text{C}$ accuracy specification .....	5
• Added typical supply current specification .....	6
• Changed from 942.547 to 942.552 .....	6
• Changed from 943.907 to 943.902 .....	6
• Changed from 890.423 to 890.500 .....	6
• Changed from 891.934 to 891.857 .....	6
• Added $-20^{\circ}\text{C}$ histogram curve .....	8
• Removed erroneous $10^{\circ}\text{C}$ histogram .....	8
• Changed y axis units from (V) to (mV) .....	9
• Added Output Noise vs Frequency curve .....	10

## 6 Device Comparison Table

Order Number	Matching Specification Provided <sup>(1)</sup>
LMT70YFQR, LMT70YFQT	No
LMT70AYFQR, LMT70AYFQT	Yes, 0.1°C at approximately 30°C <sup>(1)</sup>

- (1) In order to meet the matching specification of the LMT70A, two units must be picked from adjacent positions from one tape and reel. If PCB rework is required, involving the LMT70A, then the pair of the LMT70A matched units must be replaced. Matching features (which include, without limitation, electrical matching characteristics of adjacent Components as they are delivered in original packaging from TI) are warranted solely to the extent that the purchaser can demonstrate to TI's satisfaction that the particular Component(s) at issue were adjacent in original packaging as delivered by TI. Customers should be advised that the small size of these Components means they are not individually traceable at the unit level and it may be difficult to establish the original position of the Components once they have been removed from that original packaging as delivered by TI.

## 7 Pin Configuration and Functions

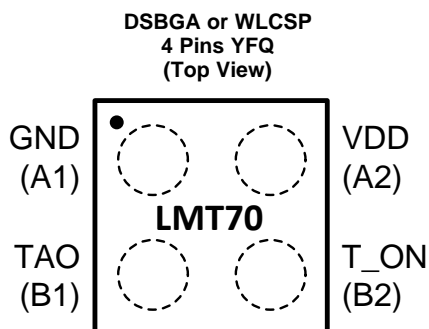

**Pin Functions**

PIN		TYPE	EQUIVALENT CIRCUIT	DESCRIPTION
NAME	NO.			
GND	A1	Ground		Ground reference for the device
VDD	A2	Power		Supply voltage
TAO	B1	Analog Output		Temperature analog output pin
T_ON	B2	Digital Input		T_ON pin. Active High input. If T_ON = 0, then the TAO output is open. If T_ON = 1, then TAO pin is connected to the temperature output voltage. Tie this pin to VDD if not used.

## 8 Specifications

### 8.1 Absolute Maximum Ratings<sup>(1)(2)</sup>

	MIN	MAX	UNIT
Supply voltage	-0.3	6	V
Voltage at T_ON and TAO	-0.3	6	V
Current at any pin		5	mA
Storage temperature, T <sub>stg</sub>	-65	150	°C

- (1) Stresses beyond those listed under *Absolute Maximum Ratings* may cause permanent damage to the device. These are stress ratings only, which do not imply functional operation of the device at these or any other conditions beyond those indicated under *Recommended Operating Conditions*. Exposure to absolute-maximum-rated conditions for extended periods may affect device reliability.
- (2) Soldering process must comply with Reflow Temperature Profile specifications. Refer to [www.ti.com/packaging](http://www.ti.com/packaging).

### 8.2 ESD Ratings

		VALUE	UNIT
V <sub>(ESD)</sub> Electrostatic discharge	Human-body model (HBM), per ANSI/ESDA/JEDEC JS-001 <sup>(1)</sup>	±2000	V
	Charged-device model (CDM), per JEDEC specification JESD22-C101 <sup>(2)</sup>	±750	

- (1) JEDEC document JEP155 states that 500-V HBM allows safe manufacturing with a standard ESD control process.
- (2) JEDEC document JEP157 states that 250-V CDM allows safe manufacturing with a standard ESD control process.

### 8.3 Recommended Operating Conditions

	MIN	NOM	MAX	UNIT
Specified temperature (T <sub>MIN</sub> ≤ T <sub>A</sub> ≤ T <sub>MAX</sub> )	-55		150	°C
Supply voltage	2.0		5.5	V

### 8.4 Thermal Information

THERMAL METRIC <sup>(1)</sup>		LMT70 DSBGA or WLCSP YFQ 4 PINS	UNIT
R <sub>θJA</sub>	Junction-to-ambient thermal resistance	187	°C/W
R <sub>θJC(top)</sub>	Junction-to-case (top) thermal resistance	2.3	
R <sub>θJB</sub>	Junction-to-board thermal resistance	105	
ψ <sub>JT</sub>	Junction-to-top characterization parameter	10.9	
ψ <sub>JB</sub>	Junction-to-board characterization parameter	104	
	Thermal response time to 63% of final value in stirred oil (dominated by PCB see layout)	1.5	sec
	Thermal response time to 63% of final value in still air (dominated by PCB see layout)	73	sec

- (1) For more information about traditional and new thermal metrics, see the *IC Package Thermal Metrics* application report, [SPRA953](http://SPRA953).

## 8.5 Electrical Characteristics

Limits apply for  $T_A = T_J = T_{MIN}$  to  $T_{MAX}$  and  $V_{DD}$  of 2.00V to 5.5V and  $V_{DD} \geq V_{TAO} + 1V$ , unless otherwise noted.

PARAMETER		TEST CONDITIONS		MIN	TYP	MAX	UNIT
<b>TEMPERATURE ACCURACY</b>							
TAO accuracy (These stated accuracy limits are with reference to the values in <a href="#">Electrical Characteristics Temperature Lookup Table (LUT)</a> , LMT70 temperature-to-voltage.) <sup>(1)</sup>	$T_A = -55^\circ\text{C}$	$V_{DD} = 2.7\text{ V}$	-0.33			0.33	°C
	$T_A = -40^\circ\text{C}$	$V_{DD} = 2.7\text{ V}$	-0.27			0.27	
	$T_A = -20^\circ\text{C}$	$V_{DD} = 2.7\text{ V}$	-0.2			0.2	
	$T_A = -10^\circ\text{C}$	$V_{DD} = 2.7\text{ V}$	-0.18			0.18	
	$T_A = 20^\circ\text{C to } 42^\circ\text{C}$	$V_{DD} = 2.7\text{ V}$	-0.13	±0.05		0.13	
	$T_A = 50^\circ\text{C}$	$V_{DD} = 2.7\text{ V}$	-0.15			0.15	
	$T_A = 90^\circ\text{C}$	$V_{DD} = 2.7\text{ V}$	-0.20			0.20	
	$T_A = 110^\circ\text{C}$	$V_{DD} = 2.7\text{ V}$	-0.23			0.23	
	$T_A = 150^\circ\text{C}$	$V_{DD} = 2.7\text{ V}$	-0.36			0.36	
ATC	Accuracy temperature coefficient (note, uses end point calculations) <sup>(2)</sup>	$V_{DD} = 2.7\text{ V}$	-2.6			+2.6	m°C/°C
APSS	Accuracy power supply sensitivity (note uses end point calculations)	$-55^\circ\text{C} \leq T_A \leq 10^\circ\text{C}$	$V_{DD} = V_{TAO} + 1.1\text{ V to } 4.0\text{ V}$	-9	-2	8	m°C/V
		$10^\circ\text{C} \leq T_A \leq 120^\circ\text{C}$	$V_{DD} = 2.0\text{ V to } 4.0\text{ V}$				
		$120^\circ\text{C} \leq T_A \leq 150^\circ\text{C}$	$V_{DD} = 2.0\text{ V to } 4.0\text{ V}$	-15		8	
			$V_{DD} = 4\text{ V to } 5.5\text{ V}$	-30	-12	0	
$V_{TAO}$	Output Voltage	$T_A = 30^\circ\text{C}$	$V_{DD} = 2.7\text{ V}$		943.227		mV
	Sensor gain				-5.194		mV/°C
	Matching of two adjacent parts in tape and reel for LMT70AYFQR, LMT70AYFQT only (see curve <a href="#">Figure 19</a> for specification at other temperatures) <sup>(3)(2)</sup>	$T_A$ approximately $30^\circ\text{C}$	$V_{DD} = 2.0\text{ V to } 3.6\text{ V}$			0.1	°C
		$T_A = 30^\circ\text{C to } 150^\circ\text{C}$				2.5	m°C/°C
		$T_A = 20^\circ\text{C to } 30^\circ\text{C}$	$V_{DD} = 2.0\text{ V to } 3.6\text{ V}$	-2.5			
		$T_A = -55^\circ\text{C to } 30^\circ\text{C}$	$V_{DD} = 2.7\text{ V to } 3.6\text{ V}$	-2.5			
	Time stability <sup>(4)</sup>	10k hours at $90^\circ\text{C}$		-0.1	±0.01	0.1	°C
<b>ANALOG OUTPUT</b>							
	Operating output voltage change with load current	$0\ \mu\text{A} \leq I_L \leq 5\ \mu\text{A}$		0		0.4	mV
		$-5\ \mu\text{A} \leq I_L \leq 0\ \mu\text{A}$		-0.4		0	mV
ROUT	Output Resistance				28	80	Ω
	TAO Off Leakage Current	$V_{TAO} \leq V_{DD} - 0.6\text{ V}$ , $V_{T\_ON} = \text{GND}$			0.005	0.5	μA
		$V_{TAO} \geq 0.2\text{ V}$ , $V_{T\_ON} = \text{GND}$		-0.5	-0.005		
	Output Load Capacitance					1100	pF

- Accuracy is defined as the error between the measured and reference output voltages, tabulated in the Conversion Table at the specified conditions of supply voltage and temperature (expressed in °C). These stated accuracy limits are with reference to the values in [Electrical Characteristics Temperature Lookup Table \(LUT\)](#), see Accuracy Curve for other temperatures. Accuracy limits do not include load regulation or aging; they assume no DC load.
- The accuracy temperature coefficient specification is given to indicate part to part performance and does not correlate to the limits given in the curve [Figure 3](#).
- In order to meet the matching specification of the LMT70A, two units must be picked from adjacent positions from one tape and reel. If PCB rework is required, involving the LMT70A, then the pair of the LMT70A matched units must be replaced. Matching features (which include, without limitation, electrical matching characteristics of adjacent Components as they are delivered in original packaging from TI) are warranted solely to the extent that the purchaser can demonstrate to TI's satisfaction that the particular Component(s) at issue were adjacent in original packaging as delivered by TI. Customers should be advised that the small size of these Components means they are not individually traceable at the unit level and it may be difficult to establish the original position of the Components once they have been removed from that original packaging as delivered by TI.
- Determined using accelerated operational life testing at  $150^\circ\text{C}$  junction temperature; not tested during production.

## Electrical Characteristics (continued)

 Limits apply for  $T_A = T_J = T_{MIN}$  to  $T_{MAX}$  and VDD of 2.00V to 5.5V and  $V_{DD} \geq V_{TAO} + 1V$ , unless otherwise noted.

PARAMETER		TEST CONDITIONS	MIN	TYP	MAX	UNIT
<b>POWER SUPPLY</b>						
VDO	Dropout Voltage ( $V_{DD} - V_{TAO}$ ) <sup>(5)</sup>	$-20^{\circ}\text{C} \leq T_A \leq 20^{\circ}\text{C}$	1.0		12	V
		$-55^{\circ}\text{C} \leq T_A \leq -20^{\circ}\text{C}$	1.1			
Power Supply Current			9.2		12	$\mu\text{A}$
Shutdown Current		$V_{DD} \leq 0.4V$ ( $-55^{\circ}\text{C}$ to $+110^{\circ}\text{C}$ )			50	nA
		$V_{DD} \leq 0.4V$ ( $+110^{\circ}\text{C}$ to $+150^{\circ}\text{C}$ )			350	nA
<b>LOGIC INPUT</b>						
T_ON Logic Low Input Threshold		$-55^{\circ}\text{C}$ to $+150^{\circ}\text{C}$	0.5	$0.33 \cdot V_{DD}$		V
T_ON Logic High Input Threshold		$-55^{\circ}\text{C}$ to $+150^{\circ}\text{C}$		$0.66 \cdot V_{DD}$	$V_{DD} - 0.5$	V
T_ON Input Current		$V_{T\_ON} = V_{DD}$		0.15	1	$\mu\text{A}$
		$V_{T\_ON} = \text{GND}$	-1	-0.02		

(5) Dropout voltage (VDO) is defined as the smallest possible differential voltage measured between  $V_{TAO}$  and VDD that causes the temperature error to degrade by  $0.02^{\circ}\text{C}$ .

## 8.6 Electrical Characteristics Temperature Lookup Table (LUT)

applies for VDD of 2.7V

TEMPERATURE ( $^{\circ}\text{C}$ )	$V_{TAO}$ (mV)			LOCAL SLOPE (mV/ $^{\circ}\text{C}$ )
	MIN	TYP	MAX	
-55	1373.576	1375.219	1376.862	-4.958
-50	1348.990	1350.441	1351.892	-4.976
-40	1299.270	1300.593	1301.917	-5.002
-30	1249.242	1250.398	1251.555	-5.036
-20	1198.858	1199.884	1200.910	-5.066
-10	1148.145	1149.070	1149.995	-5.108
0	1097.151	1097.987	1098.823	-5.121
10	1045.900	1046.647	1047.394	-5.134
20	994.367	995.050	995.734	-5.171
30	942.547	943.227	943.902	-5.194
40	890.500	891.178	891.857	-5.217
50	838.097	838.882	839.668	-5.241
60	785.509	786.360	787.210	-5.264
70	732.696	733.608	734.520	-5.285
80	679.672	680.654	681.636	-5.306
90	626.435	627.490	628.545	-5.327
100	572.940	574.117	575.293	-5.347
110	519.312	520.551	521.789	-5.368
120	465.410	466.760	468.110	-5.391
130	411.288	412.739	414.189	-5.430
140	356.458	358.164	359.871	-5.498
150	300.815	302.785	304.756	-5.538

### 8.7 Switching Characteristics

Limits apply for  $T_A = T_J = T_{MIN}$  to  $T_{MAX}$  and  $V_{DD}$  of 2.00V to 5.5V and  $V_{DD} \geq V_{TAO} + 1V$ , unless otherwise noted.

PARAMETER	TEST CONDITIONS	MIN	TYP	MAX	UNIT
$t_{POWER}$	Power-on Time to 99% of final voltage value		0.6	1	ms
$t_{T\_ON}$	T_ON Time to 99% of final voltage value (note dependent on RON and C load)		30	500	$\mu s$
$C_{T\_ON}$	T_ON Digital Input Capacitance		2.2		pF

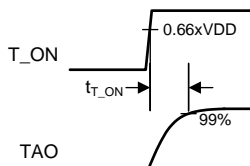

Figure 1. Definition of  $t_{T\_ON}$

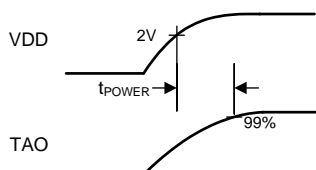
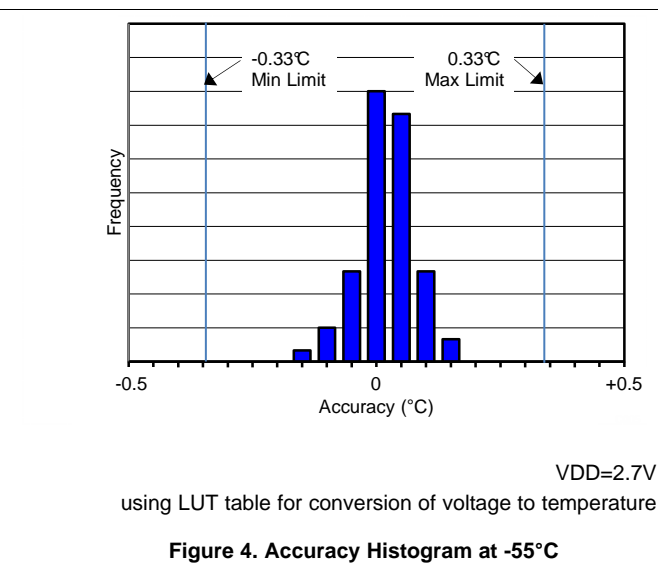
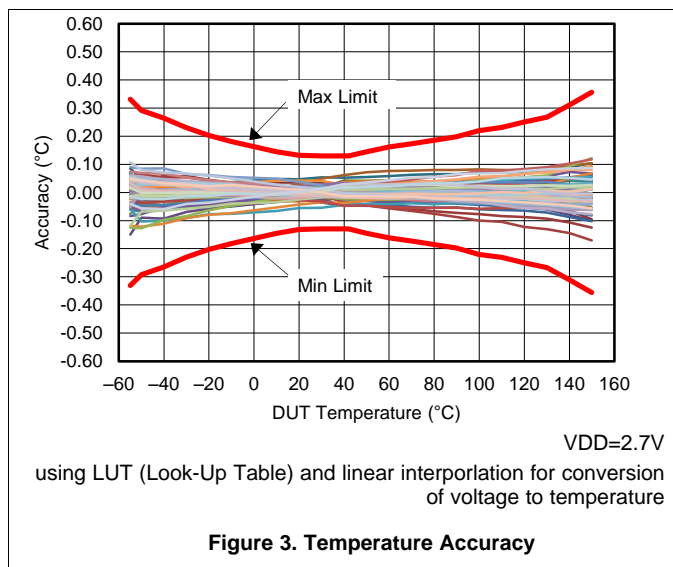
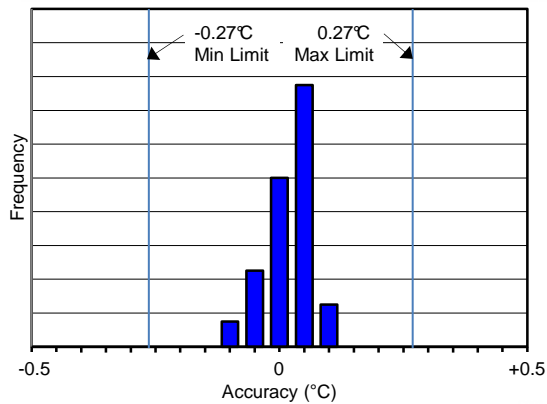

Figure 2. Definition of  $t_{POWER}$

### 8.8 Typical Performance Characteristics



**Typical Performance Characteristics (continued)**

VDD=2.7V  
using LUT table for conversion of voltage to temperature

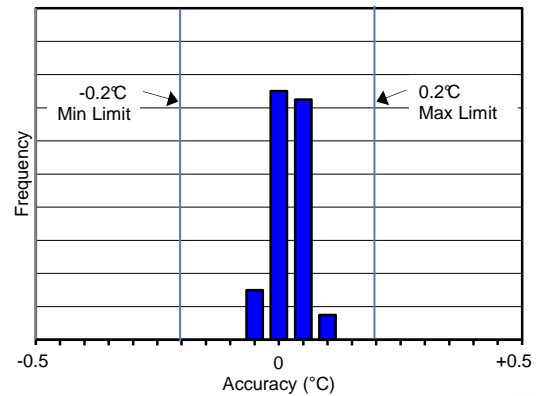
**Figure 5. Accuracy Histogram at -40°C**

VDD=2.7V  
using LUT table for conversion of voltage to temperature

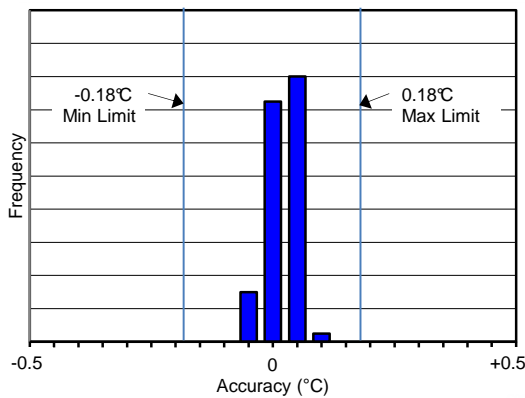
**Figure 6. Accuracy Histogram at -20°C**

VDD=2.7V  
using LUT table for conversion of voltage to temperature

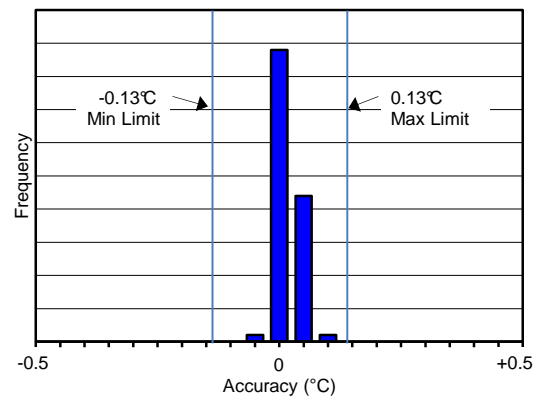
**Figure 7. Accuracy Histogram at -10°C**

VDD=2.7V  
using LUT table for conversion of voltage to temperature

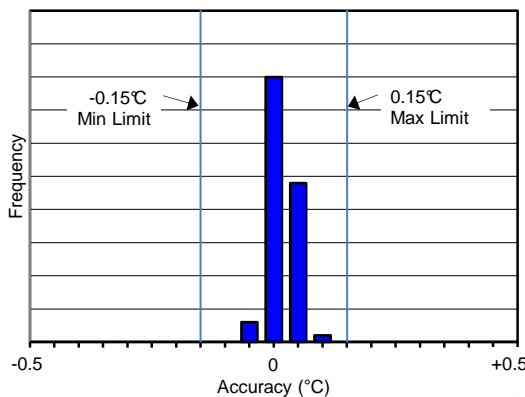
**Figure 8. Accuracy Histogram at 30°C**

VDD=2.7V  
using LUT table for conversion of voltage to temperature

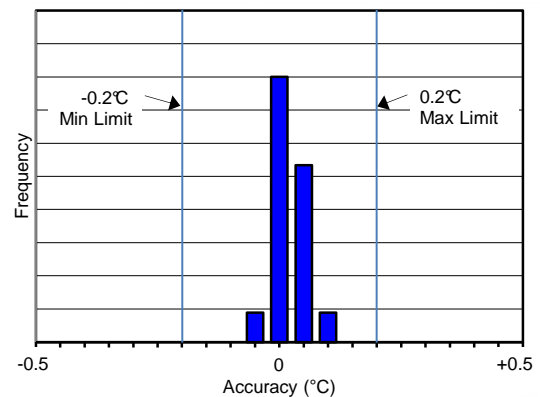
**Figure 9. Accuracy Histogram at 50°C**

VDD=2.7V  
using LUT table for conversion of voltage to temperature

**Figure 10. Accuracy Histogram at 90°C**



Typical Performance Characteristics (continued)

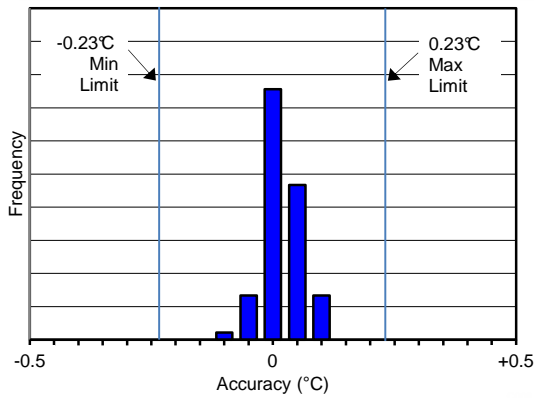

VDD=2.7V  
using LUT table for conversion of voltage to temperature

Figure 11. Accuracy Histogram at 110°C

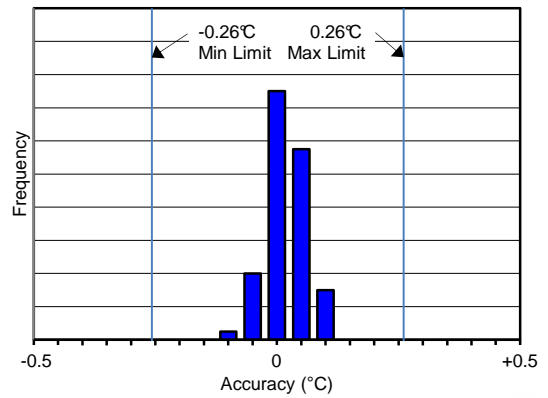

VDD=2.7V  
using LUT table for conversion of voltage to temperature

Figure 12. Accuracy Histogram at 120°C

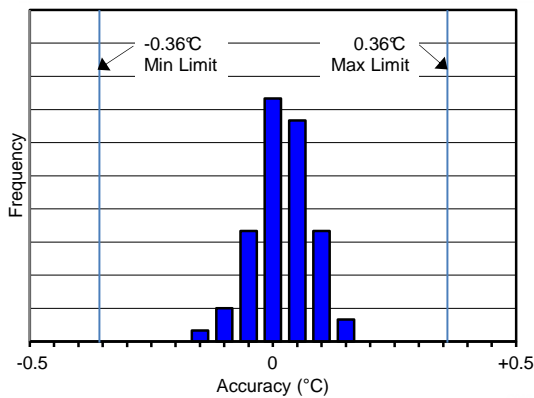

VDD=2.7V  
using LUT table for conversion of voltage to temperature

Figure 13. Accuracy Histogram at 150°C

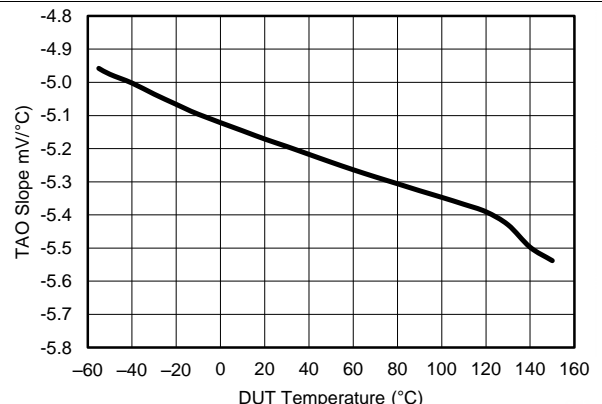

VDD=2.7V

Figure 14. TAO first order transfer function slope vs temperature

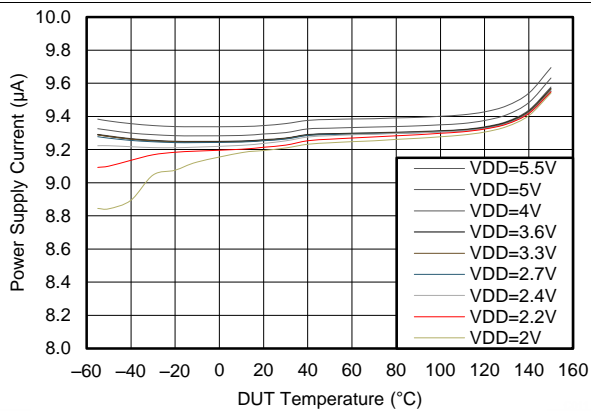

Figure 15. IDD vs Temperature at Various VDD

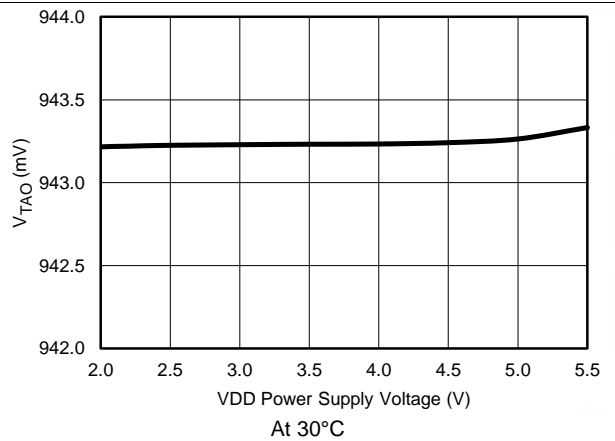
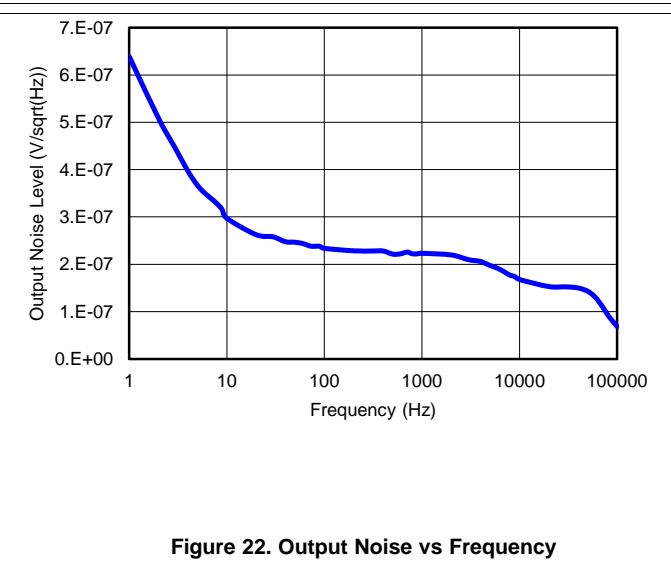
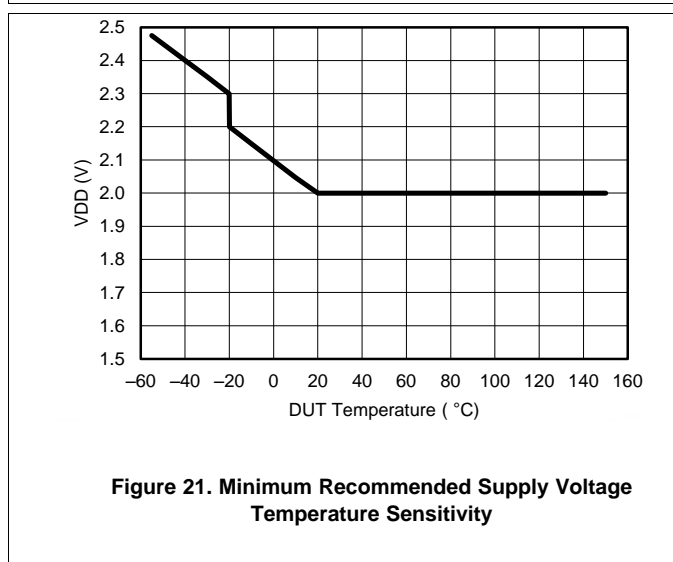
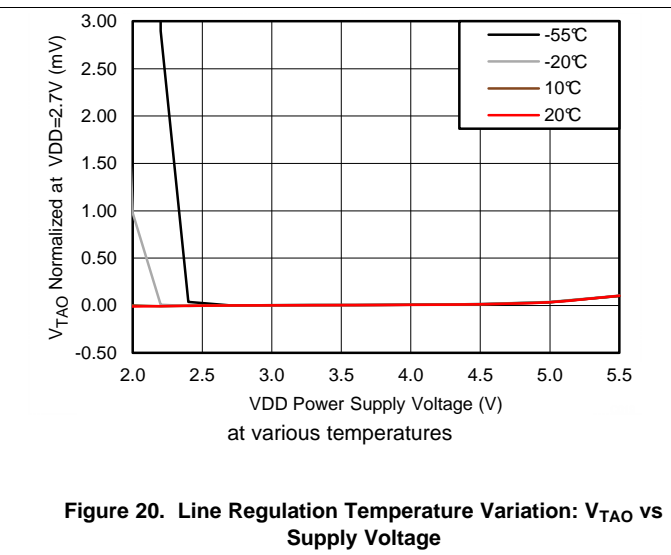
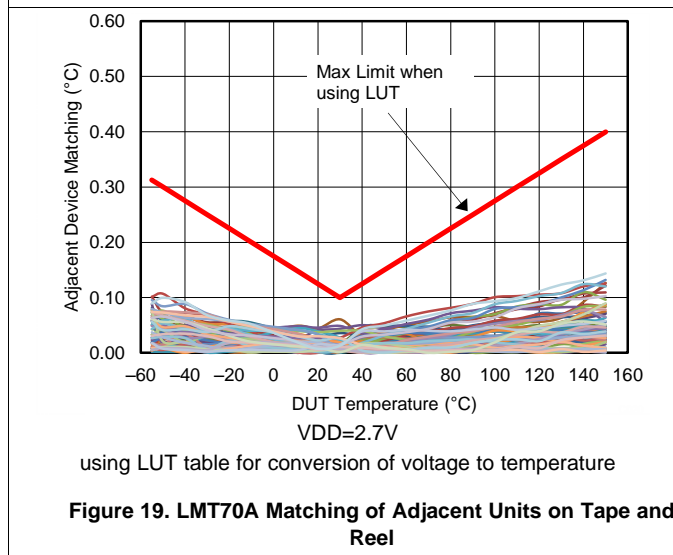
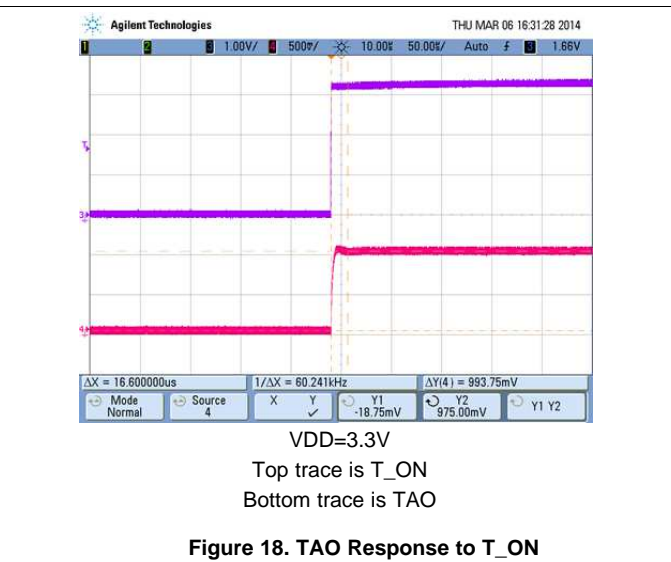
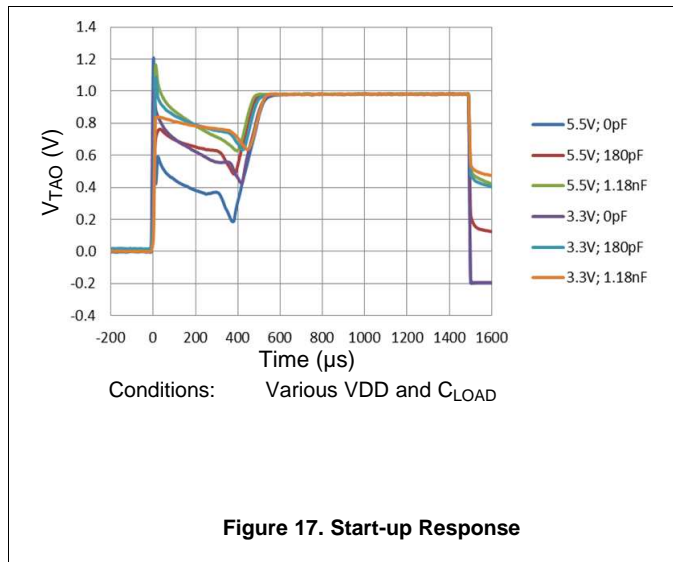

Figure 16. TAO Line Regulation  
At 30°C

Typical Performance Characteristics (continued)



## 9 Detailed Description

### 9.1 Overview

The LMT70 is a precision analog output temperature sensor. It includes an output switch that is controlled by the T\_ON digital input. The output switch enables the multiplexing of several devices onto a single ADC input thus expanding on the ADC input multiplexer capability.

The temperature sensing element is comprised of simply stacked BJT base emitter junctions that are biased by a current source. The temperature sensing element is then buffered by a precision amplifier before being connected to the output switch. The output amplifier has a simple class AB push-pull output stage that enables the device to easily source and sink current.

### 9.2 Functional Block Diagram

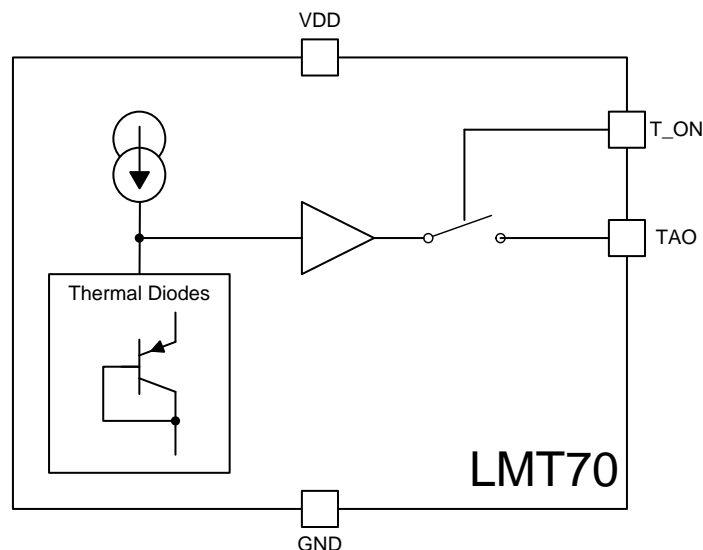

### 9.3 Feature Description

#### 9.3.1 Temperature Analog Output (TAO)

The TAO push-pull output provides the ability to sink and source current. This is beneficial when, for example, driving dynamic loads like an input stage on an analog-to-digital converter (ADC). In these applications the source current is required to quickly charge the input capacitor of the ADC. See the [Typical Application](#) section for more discussion of this topic. The LMT70 is ideal for this and other applications which require strong source or sink current.

##### 9.3.1.1 LMT70 Output Transfer Function

The LMT70 output voltage transfer function appears to be linear, but upon close inspection it can be seen that it is truly not linear and can be better described by a second or third order transfer function equation.

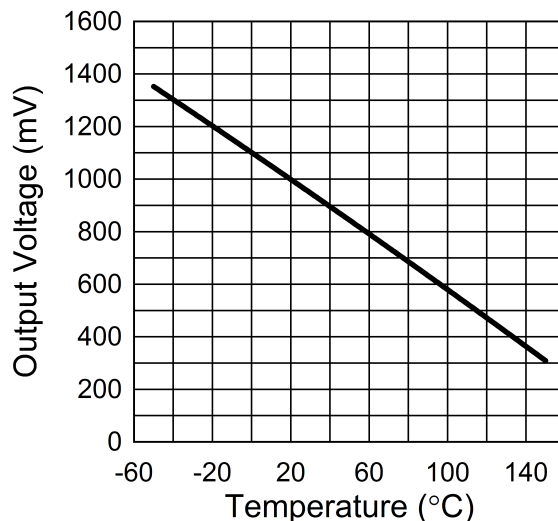
**Feature Description (continued)**

**Figure 23. LMT70 Output Transfer Function**
**9.3.1.1.1 First Order Transfer Function**

A first order transfer function can be used to calculate the temperature LMT70 is sensing but over a wide temperature range it is the least accurate method. An equation can be easily generated using the LUT (Look-Up Table) information found in [Electrical Characteristics Temperature Lookup Table \(LUT\)](#).

Over a narrow 10°C temperature range a linear equation will yield very accurate results. It is actually recommended that over a 10°C temperature range linear interpolation be used to calculate the temperature the device is sensing. When this method is used the accuracy minimum and maximum specifications would meet the values given in [Figure 3](#).

For example the first order equation between 20°C and 30°C can be generated using the typical output voltage levels as given in [Electrical Characteristics Temperature Lookup Table \(LUT\)](#) and partially repeated here for reference from 20°C to 50°C:

**Feature Description (continued)**
**Table 1. Output Voltage LUT**

Temperature (°C)	V <sub>TAO</sub> (mV)			Local Slope (mV/°C)
	MIN	TYP	MAX	
20	994.367	995.050	995.734	-5.171
30	942.547	943.227	943.907	-5.194
40	890.423	891.178	891.934	-5.217
50	838.097	838.882	839.668	-5.241

First calculate the slope:

$$m = (T_1 - T_2) \div [(V_{TAO}(T_1) - V_{TAO}(T_2))]$$

$$m = (20^\circ\text{C} - 30^\circ\text{C}) \div (995.050 \text{ mV} - 943.227 \text{ mV})$$

$$m = -0.193 \text{ }^\circ\text{C/mV}$$

Then calculate the y intercept b:

$$b = (T_1) - (m \times V_{TAO}(T_1))$$

$$b = 20^\circ\text{C} - (-0.193 \text{ }^\circ\text{C/mV} \times 995.050 \text{ mV})$$

$$b = 212.009^\circ\text{C}$$

Thus the final equation used to calculate the measured temperature ( $T_M$ ) in the range between 20°C and 30°C is:

$$T_M = m \times V_{TAO} + b$$

$$T_M = -0.193 \text{ }^\circ\text{C/mV} \times V_{TAO} + 212.009^\circ\text{C}$$

where  $V_{TAO}$  is in mV and  $T_M$  is in °C.

**9.3.1.1.2 Second Order Transfer Function**

A second order transfer function can give good results over a wider limited temperature range. Over the full temperature range of -55°C to +150°C a single second order transfer function will have increased error at the temperature extremes. Using least squares sum method a best fit second order transfer function was generated using the values in [Electrical Characteristics Temperature Lookup Table \(LUT\)](#):

$$T_M = a (V_{TAO})^2 + b (V_{TAO}) + c$$

where:

	Best fit for -55°C to 150°C	Best fit for -10°C to 110°C
a	-8.451576E-06	-7.857923E-06
b	-1.769281E-01	-1.777501E-01
c	2.043937E+02	2.046398E+02

and  $V_{TAO}$  is in mV and  $T_M$  is in °C.

### 9.3.1.1.3 Third Order Transfer Function

Over a wide temperature range the most accurate single equation is a third order transfer function. Using least squares sum method a best fit third order transfer function was generated using the values in [Figure 3](#):

$$T_M = a (V_{TAO})^3 + b (V_{TAO})^2 + c(V_{TAO}) + d$$

where:

	Best fit for -55°C to 150°C	Best fit for -10°C to 110°C
a	-1.064200E-09	-1.809628E-09
b	-5.759725E-06	-3.325395E-06
c	-1.789883E-01	-1.814103E-01
d	2.048570E+02	2.055894E+02

and  $V_{TAO}$  is in mV and  $T_M$  is in °C.

### 9.3.1.2 LMT70A TAO Matching

In order to meet the matching specification of the LMT70A, two units must be picked from adjacent positions from one tape and reel. If PCB rework is required, involving the LMT70A, then the pair of the LMT70A matched units must be replaced. Matching features (which include, without limitation, electrical matching characteristics of adjacent Components as they are delivered in original packaging from TI) are warranted solely to the extent that the purchaser can demonstrate to TI's satisfaction that the particular Component(s) at issue were adjacent in original packaging as delivered by TI. Customers should be advised that the small size of these components means they are not individually traceable at the unit level and it may be difficult to establish the original position of the Components once they have been removed from that original packaging as delivered by TI.

### 9.3.1.3 TAO Noise Considerations

A load capacitor on TAO pin can help to filter noise.

For noisy environments, TI recommends at minimum 100 nF supply decoupling capacitor placed close across VDD and GND pins of LMT70.

### 9.3.1.4 TAO Capacitive Loads

TAO handles capacitive loading well. In an extremely noisy environment, or when driving a switched sampling input on an ADC, it may be necessary to add some filtering to minimize noise coupling. Without any precautions, the  $V_{TAO}$  can drive a capacitive load less than or equal to 1 nF as shown in [Figure 24](#). For capacitive loads greater than 1 nF, a series resistor is required on the output, as shown in [Figure 25](#), to maintain stable conditions.

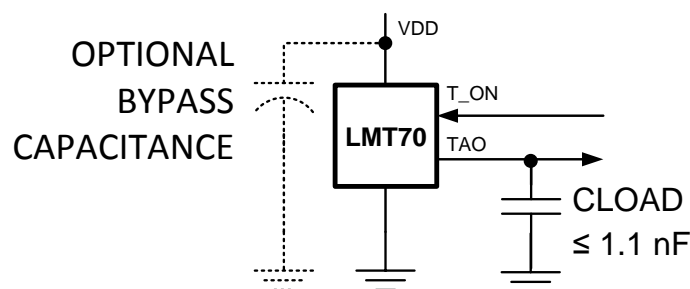

**Figure 24. LMT70 No Isolation Resistor Required**

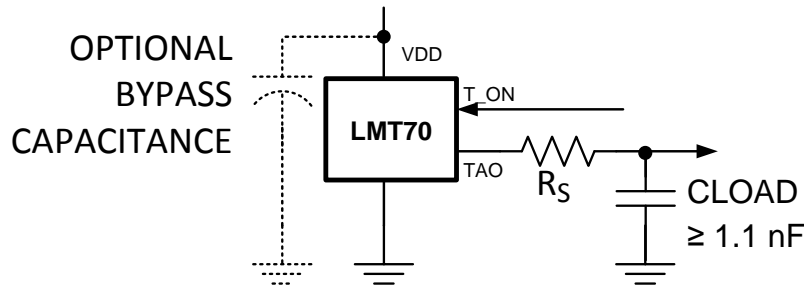

Figure 25. LMT70 With Series Resistor for Capacitive Loading Greater than 1 nF

Table 2.  $C_{LOAD}$  and  $R_S$  Values of Figure 25

$C_{LOAD}$	Minimum $R_S$
1.1 to 90 nF	3 k $\Omega$
90 to 900 nF	1.5 k $\Omega$
0.9 $\mu$ F	750 $\Omega$

### 9.3.2 T<sub>ON</sub> Digital Input

The T<sub>ON</sub> digital input enables and disables the analog output voltage presented at the TAO pin by controlling the state of the internal switch that is in series with the internal temperature sensor circuitry output. When T<sub>ON</sub> is driven to a logic "HIGH" the temperature sensor output voltage is present on the TAO pin. When T<sub>ON</sub> is set to a logic "LOW" the TAO pin is set to a high impedance state.

### 9.3.3 Light Sensitivity

Although the LMT70 package has a protective backside coating that reduces the amount of light exposure on the die, unless it is fully shielded, ambient light will still reach the active region of the device from the side of the package. Depending on the amount of light exposure in a given application, an increase in temperature error should be expected. In circuit board tests under ambient light conditions, a typical increase in error may not be observed and is dependent on the angle that the light approaches the package. The LMT70 is most sensitive to IR radiation. Best practice should include end-product packaging that provides shielding from possible light sources during operation.

## 9.4 Device Functional Modes

The LMT70 is a simple precise analog output temperature sensor with a switch in series with its output. It has only two functional modes: output on or output off.

## 10 Application and Implementation

### NOTE

Information in the following applications sections is not part of the TI component specification, and TI does not warrant its accuracy or completeness. TI's customers are responsible for determining suitability of components for their purposes. Customers should validate and test their design implementation to confirm system functionality.

### 10.1 Application Information

The LMT70 analog output temperature sensor is an ideal device to connect to an integrated 12-Bit ADC such as that found in the MSP430 microcontroller family.

Applications for the LMT70 included but are not limited to: IoT based temperature sensor nodes, medical fitness equipment (e.g. thermometers, fitness/smart bands or watches, activity monitors, human body temperature monitor), Class AA or lower RTD replacement, precision NTC or PTC thermistor replacement, instrumentation temperature compensation, metering temperature compensation (e. g. heat cost allocator, heat meter).

### 10.2 Typical Application

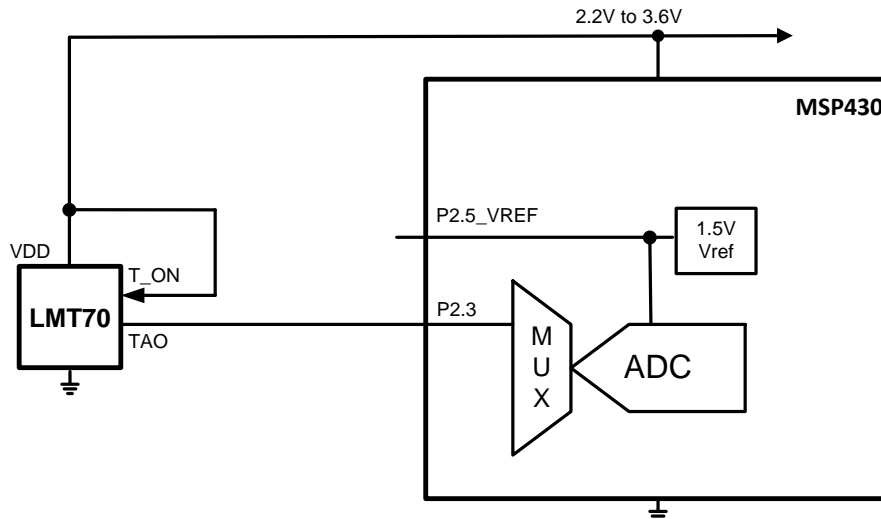

**Figure 26. Typical Application Schematic**

Most CMOS ADCs found in microcontrollers and ASICs have a sampled data comparator input structure. When the ADC charges the sampling cap, it requires instantaneous charge from the output of the analog source such as the LMT70 temperature sensor and many op amps. This requirement is easily accommodated by the addition of a capacitor ( $C_{\text{FILTER}}$ ) or the extension of the ADC acquisition time thus slowing the ADC sampling rate. The size of  $C_{\text{FILTER}}$  depends on the size of the sampling capacitor and the sampling frequency. Since not all ADCs have identical input stages, the charge requirements will vary. The general ADC application shown in [Figure 27](#) is an example only. The application in [Figure 26](#) was actually tried and the extension of the MSP430 12-Bit ADC acquisition time was all that was necessary in order to accommodate the LMT70's output stage drive capability.



## Typical Application (continued)

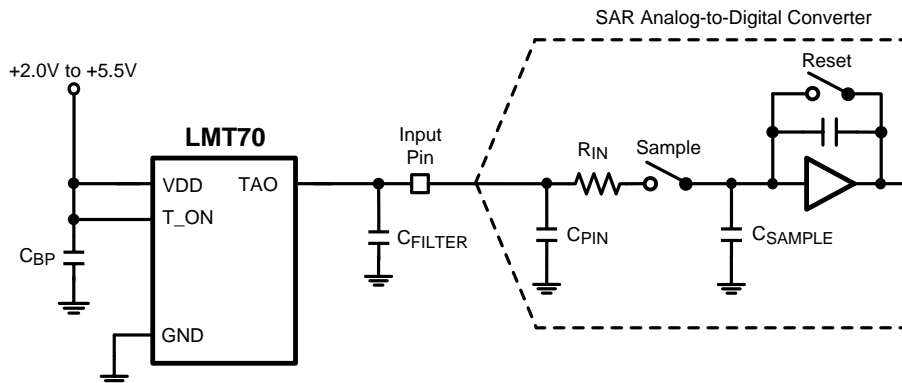

Figure 27. Suggested Connection to a Sampling Analog-to-Digital Converter Input Stage

### 10.2.1 Design Requirements

The circuit show in [Figure 26](#) will support the design requirements as shown in [Table 3](#).

Table 3. Design Requirements

PARAMETER	TARGET SPECIFICATION
Temperature Range	-40°C to +150°C LMT70, -40°C to +85°C for MSP430
Accuracy	±0.2°C typical over full temperature range
VDD	2.2V to 3.6V with typical of 3.0V
IDD	12µA

### 10.2.2 Detailed Design Procedure

#### 10.2.2.1 Temperature Algorithm Selection

Of the three algorithms presented in this datasheet, linear interpolation, second order transfer function or third order transfer function, the one selected will be determined by the users microcontroller resources and the temperature range that will be sensed. Therefore, a comparison of the expected accuracy from the LMT70 is given here. The following curves show effect on the accuracy of the LMT70 when using each of the different algorithms/equations given in [LMT70 Output Transfer Function](#). The first curve ([Figure 28](#)) shows the performance when using linear interpolation of the LUT values shown in [Electrical Characteristics Temperature Lookup Table \(LUT\)](#) of every 10°C and provides the best performance. Linear interpolation of the LUT values shown in [Electrical Characteristics Temperature Lookup Table \(LUT\)](#) is used to determine the LMT70 min/max accuracy limits as shown in the [Electrical Characteristics](#) and the red lines of [Figure 28](#). The other lines in the middle of [Figure 28](#) show independent device performance. The green limit lines, shown in the subsequent figures, apply for the specific equation used to convert the output voltage of the LMT70 to temperature. The equations are shown under each figure for reference purposes. The green lines show the min/max limits when set in a similar manner to the red limit lines of [Figure 28](#). The limits shown in red for [Figure 28](#) are repeated in all the figures of this section for comparison purposes.

# LMT70, LMT70A

ZHCSDV8A – MARCH 2015 – REVISED JULY 2015

www.ti.com.cn

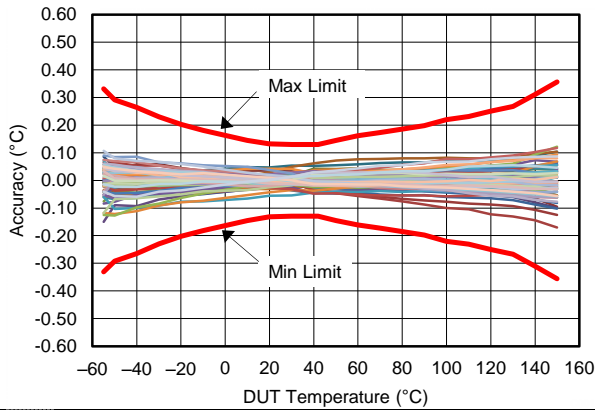

Temp (°C)	MIN	V <sub>TAO</sub> (mV) TYP	MAX	Local Slope (mV/°C)
20	994.367	995.050	995.734	-5.171
30	942.547	943.227	943.907	-5.194
40	890.423	891.178	891.934	-5.217
50	838.097	838.882	839.668	-5.241

Figure 28. LMT70 Performance Using LUT and Linear Interpolation

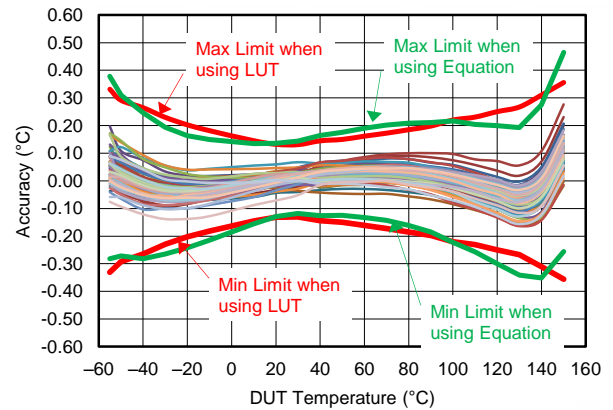

$$T_M = -1.064200E-09 (V_{TAO})^3 - 5.759725E-06 (V_{TAO})^2 - 1.789883E-01 (V_{TAO}) + 2.048570E+02$$

Figure 29. Using Third Order Transfer Function Best Fit - 55°C to +150°C

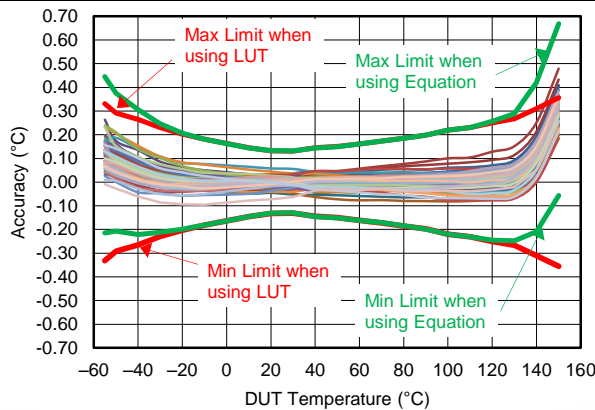

$$T_M = -1.809628E-09 (V_{TAO})^3 - 3.325395E-06 (V_{TAO})^2 - 1.814103E-01 (V_{TAO}) + 2.055894E+02$$

Figure 30. Using Third Order Transfer Function Best Fit - 10°C to +110°C

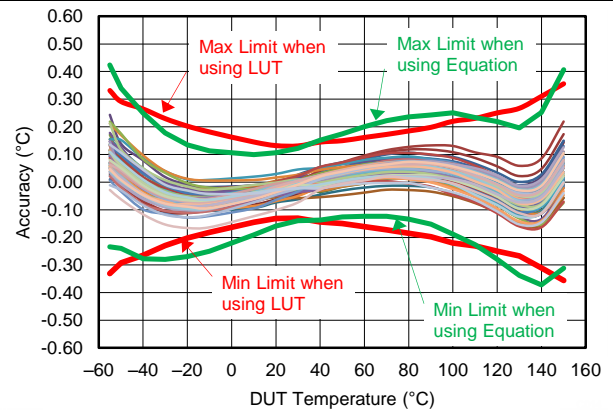

$$T_M = -8.451576E-06 (V_{TAO})^2 - 1.769281E-01 (V_{TAO}) + 2.043937E+02$$

Figure 31. Using Second Order Transfer Function Best Fit -55°C to 150°C

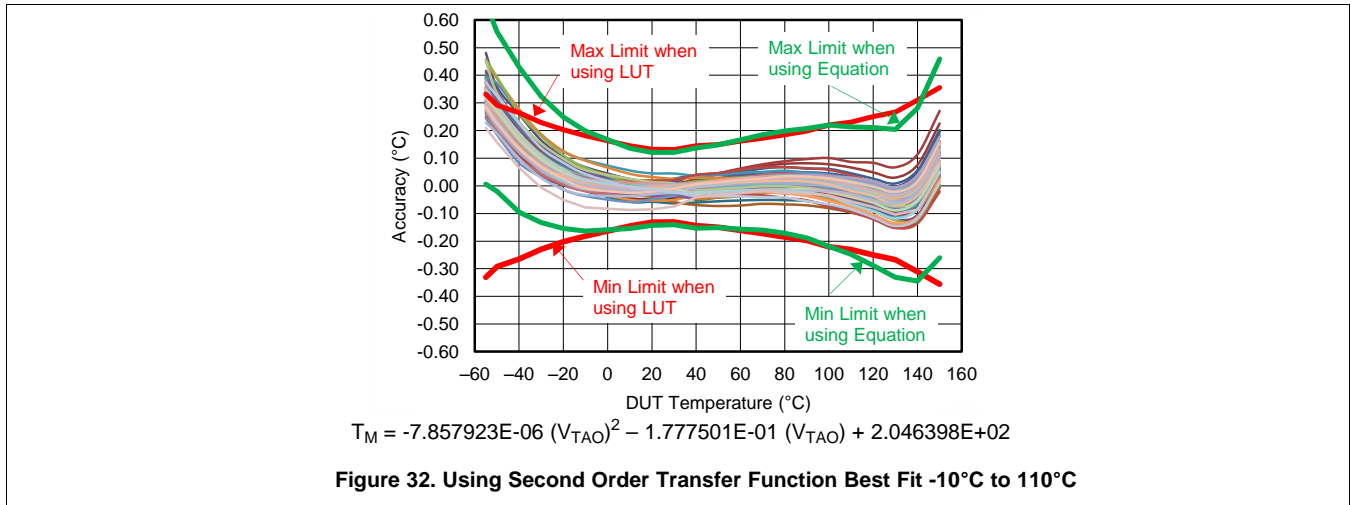

### 10.2.2.2 ADC Requirements

The ADC resolution and its specifications as well as reference voltage and its specifications will determine the overall system accuracy that you can obtain. For this example the 12-bit SAR ADC found in the MSP430 was used as well as its integrated reference. At first glance the specifications may not seem to be precise enough to actually be used with the LMT70 but the MSP430 ADC and integrated reference errors are actually measured during production testing of the MSP430. Values are then provided to user for software calibration. These calibration values are located in the MSP430A device descriptor tag-length-value (TLV) structure and found in the device-specific datasheet. The MSP430 Users Guide includes information on how to use these calibration values to calibrate the ADC reading. The specific values used to calibrate the ADC readings are: CAL\_ADC\_15VREF\_FACTOR, CAL\_ADC\_GAIN\_FACTOR and CAL\_ADC\_OFFSET.

**LMT70, LMT70A**

ZHCSDV8A – MARCH 2015 – REVISED JULY 2015

[www.ti.com.cn](http://www.ti.com.cn)
**10.2.3 Finer Resolution LUT**

The following table is given for reference only and not meant to be used for calculation purposes.

Temp (°C)	V <sub>TAO</sub> (mV)	Temp (°C)	V <sub>TAO</sub> (mV)	Temp (°C)	V <sub>TAO</sub> (mV)	Temp (°C)	V <sub>TAO</sub> (mV)	Temp (°C)	V <sub>TAO</sub> (mV)	Temp (°C)	V <sub>TAO</sub> (mV)	Temp (°C)	V <sub>TAO</sub> (mV)	Temp (°C)	V <sub>TAO</sub> (mV)
	TYP		TYP		TYP		TYP		TYP		TYP		TYP		TYP
		-30	1250.398	0	1097.987	30	943.227	60	786.360	90	627.490	120	466.760	150	302.785
		-29	1244.953	1	1092.532	31	937.729	61	780.807	91	621.896	121	460.936		
		-28	1239.970	2	1087.453	32	932.576	62	775.580	92	616.603	122	455.612		
		-27	1234.981	3	1082.370	33	927.418	63	770.348	93	611.306	123	450.280		
		-26	1229.986	4	1077.282	34	922.255	64	765.113	94	606.006	124	444.941		
-55	1375.219	-25	1224.984	5	1072.189	35	917.087	65	759.873	95	600.701	125	439.593		
-54	1370.215	-24	1219.977	6	1067.090	36	911.915	66	754.628	96	595.392	126	434.238		
-53	1365.283	-23	1214.963	7	1061.987	37	906.738	67	749.380	97	590.079	127	428.875		
-52	1360.342	-22	1209.943	8	1056.879	38	901.556	68	744.127	98	584.762	128	423.504		
-51	1355.395	-21	1204.916	9	1051.765	39	896.370	69	738.870	99	579.442	129	418.125		
-50	1350.441	-20	1199.884	10	1046.647	40	891.178	70	733.608	100	574.117	130	412.739		
-49	1345.159	-19	1194.425	11	1041.166	41	885.645	71	728.055	101	568.504	131	406.483		
-48	1340.229	-18	1189.410	12	1036.062	42	880.468	72	722.804	102	563.192	132	401.169		
-47	1335.293	-17	1184.388	13	1030.952	43	875.287	73	717.550	103	557.877	133	395.841		
-46	1330.352	-16	1179.361	14	1025.838	44	870.100	74	712.292	104	552.557	134	390.499		
-45	1325.405	-15	1174.327	15	1020.720	45	864.909	75	707.029	105	547.233	135	385.144		
-44	1320.453	-14	1169.288	16	1015.596	46	859.713	76	701.762	106	541.905	136	379.775		
-43	1315.496	-13	1164.242	17	1010.467	47	854.513	77	696.491	107	536.573	137	374.393		
-42	1310.534	-12	1159.191	18	1005.333	48	849.307	78	691.217	108	531.236	138	368.997		
-41	1305.566	-11	1154.134	19	1000.194	49	844.097	79	685.937	109	525.895	139	363.587		
-40	1300.593	-10	1149.070	20	995.050	50	838.882	80	680.654	110	520.551	140	358.164		
-39	1295.147	-9	1143.654	21	989.583	51	833.343	81	675.073	111	514.886	141	351.937		
-38	1290.202	-8	1138.599	22	984.450	52	828.141	82	669.803	112	509.557	142	346.508		
-37	1285.250	-7	1133.540	23	979.313	53	822.934	83	664.528	113	504.223	143	341.071		
-36	1280.291	-6	1128.476	24	974.171	54	817.723	84	659.250	114	498.885	144	335.625		
-35	1275.326	-5	1123.407	25	969.025	55	812.507	85	653.967	115	493.542	145	330.172		
-34	1270.353	-4	1118.333	26	963.875	56	807.287	86	648.680	116	488.195	146	324.711		
-33	1265.375	-3	1113.254	27	958.720	57	802.062	87	643.389	117	482.843	147	319.241		
-32	1260.389	-2	1108.170	28	953.560	58	796.832	88	638.094	118	477.486	148	313.764		
-31	1255.397	-1	1103.081	29	948.396	59	791.598	89	632.794	119	472.125	149	308.279		

### 10.2.4 Application Curves

The LMT70 performance using the MSP430 with integrated 12-bit ADC is shown in Figure 33. This curve includes the error of the MSP430 integrated 12-bit ADC and reference as shown in the schematic Figure 26. The MSP430 was kept at room temperature and the LMT70 was submerged in a precision temperature calibration oil bath. A calibrated temperature probe was used to monitor the temperature of the oil. As can be seen in Figure 33 the combined performance on the MSP430 and the LMT70 is better than 0.12°C for the entire -40°C to +150°C temperature range. The only calibration performed was with software using the MSP430A device descriptor tag-length-value (TLV) calibration values for ADC and VREF error.

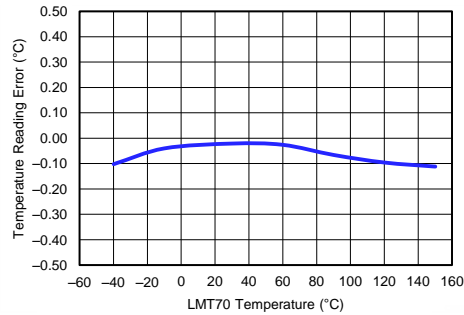

**Figure 33. LMT70 with MSP430 typical performance**

### 10.3 System Examples

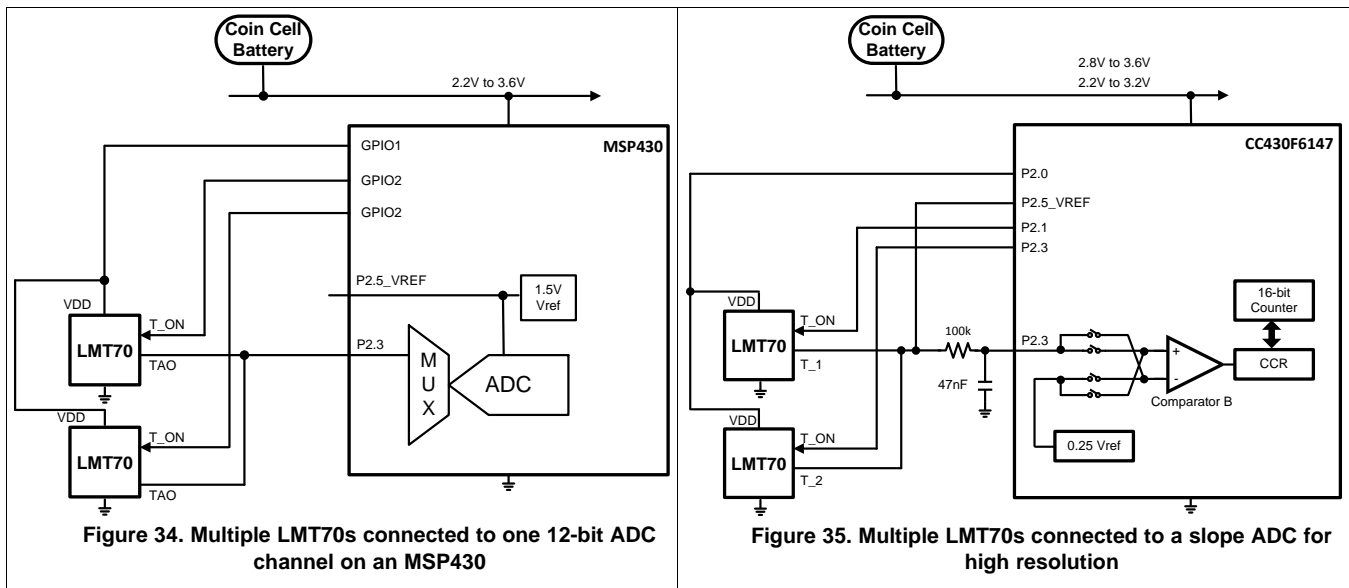

**Figure 34. Multiple LMT70s connected to one 12-bit ADC channel on an MSP430**

**Figure 35. Multiple LMT70s connected to a slope ADC for high resolution**

## 11 Power Supply Recommendations

Power supply bypass capacitors are optional and may be required if the supply line is noisy. It is recommended that a local supply decoupling capacitor be used to reduce noise. For noisy environments, TI recommends a 100 nF supply decoupling capacitor placed closed across VDD and GND pins of LMT70.

## 12 Layout

### 12.1 Layout Guidelines

The LMT70 can be applied easily in the same way as other integrated-circuit temperature sensors. It can be glued or cemented to a surface. The temperatures of the lands and traces to the other leads of the LMT70 will also affect the temperature reading.

#### 12.1.1 Mounting and Temperature Conductivity

Alternatively, the LMT70 can be mounted inside a sealed-end metal tube, and can then be dipped into a bath or screwed into a threaded hole in a tank. As with any IC, the LMT70 and accompanying wiring and circuits must be kept insulated and dry, to avoid leakage and corrosion. This is especially true if the circuit may operate at cold temperatures where condensation can occur. If moisture creates a short circuit from the TAO output to ground or VDD, the TAO output from the LMT70 will not be correct. Printed-circuit coatings are often used to ensure that moisture cannot corrode the leads or circuit traces.

The LMT70's junction temperature is the actual temperature being measured. The thermal resistance junction-to-ambient ( $R_{\theta JA}$ ) is the parameter (from [Thermal Information](#)) used to calculate the rise of a device junction temperature due to its power dissipation. [Equation 1](#) is used to calculate the rise in the LMT70's die temperature.

$$T_J = T_A + R_{\theta JA} [(V_{DD}I_Q) + (V_{DD} - V_{TEMP}) I_L]$$

where

- $T_A$  is the ambient temperature.
- $I_Q$  is the quiescent current.
- $I_L$  is the load current on  $V_{TEMP}$ .

(1)

For example, in an application where  $T_A = 30^\circ\text{C}$ ,  $V_{DD} = 3\text{ V}$ ,  $I_{DD} = 12\mu\text{A}$ ,  $V_{TAO} = 943.227\text{ mV}$ , and  $I_L = 0\mu\text{A}$ , the total temperature rise would be  $[187^\circ\text{C/W} \times 3\text{ V} \times 12\mu\text{A}] = 0.007^\circ\text{C}$ . To minimize self-heating, the load current on TAO pin should be minimized.

### 12.2 Layout Example

 VIA to power plane

 VIA to ground plane

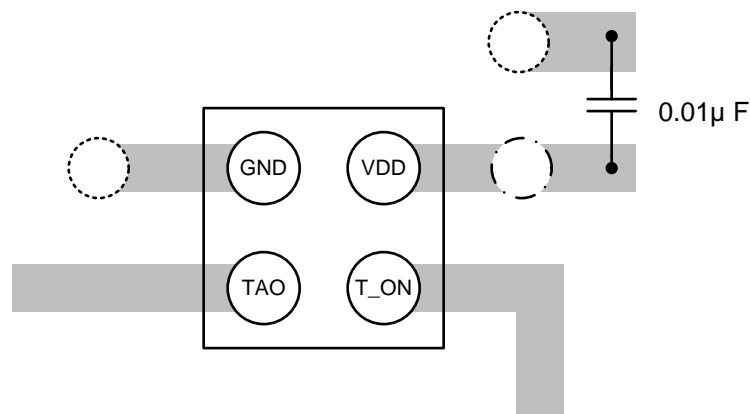

## 13 器件和文档支持

### 13.1 相关链接

以下表格列出了快速访问链接。范围包括技术文档、支持与社区资源、工具和软件，并且可以快速访问样片或购买链接。

表 4. 相关链接

器件	产品文件夹	样片与购买	技术文档	工具与软件	支持与社区
LMT70	<a href="#">请单击此处</a>	<a href="#">请单击此处</a>	<a href="#">请单击此处</a>	<a href="#">请单击此处</a>	<a href="#">请单击此处</a>
LMT70A	<a href="#">请单击此处</a>	<a href="#">请单击此处</a>	<a href="#">请单击此处</a>	<a href="#">请单击此处</a>	<a href="#">请单击此处</a>

### 13.2 文档支持

#### 13.2.1 相关文档

《回流温度曲线》规范。请访问 [www.ti.com/packaging](http://www.ti.com/packaging)。

应用报告《IC 封装热指标》，[SPRA953](#)

### 13.3 社区资源

The following links connect to TI community resources. Linked contents are provided "AS IS" by the respective contributors. They do not constitute TI specifications and do not necessarily reflect TI's views; see TI's [Terms of Use](#).

**TI E2E™ Online Community** *TI's Engineer-to-Engineer (E2E) Community*. Created to foster collaboration among engineers. At [e2e.ti.com](http://e2e.ti.com), you can ask questions, share knowledge, explore ideas and help solve problems with fellow engineers.

**Design Support** *TI's Design Support* Quickly find helpful E2E forums along with design support tools and contact information for technical support.

### 13.4 商标

E2E is a trademark of Texas Instruments.

All other trademarks are the property of their respective owners.

### 13.5 静电放电警告



这些装置包含有限的内置 ESD 保护。存储或装卸时，应将导线一起截短或将装置放置于导电泡棉中，以防止 MOS 门极遭受静电损伤。

### 13.6 Glossary

[SLYZ022](#) — *TI Glossary*.

This glossary lists and explains terms, acronyms, and definitions.

## 14 机械、封装和可订购信息

以下页中包括机械、封装和可订购信息。 这些信息是针对指定器件可提供的最新数据。 这些数据会在无通知且不对本文档进行修订的情况下发生改变。 欲获得该数据表的浏览器版本，请查阅左侧的导航栏。

**PACKAGING INFORMATION**

Orderable Device	Status (1)	Package Type	Package Drawing	Pins	Package Qty	Eco Plan (2)	Lead finish/ Ball material (6)	MSL Peak Temp (3)	Op Temp (°C)	Device Marking (4/5)	Samples
LMT70AYFQR	ACTIVE	DSBGA	YFQ	4	3000	RoHS & Green	SNAGCU	Level-1-260C-UNLIM	-55 to 150		<a href="#">Samples</a>
LMT70AYFQT	ACTIVE	DSBGA	YFQ	4	250	RoHS & Green	SNAGCU	Level-1-260C-UNLIM	-55 to 150		<a href="#">Samples</a>
LMT70YFQR	ACTIVE	DSBGA	YFQ	4	3000	RoHS & Green	SNAGCU	Level-1-260C-UNLIM	-55 to 150		<a href="#">Samples</a>
LMT70YFQT	ACTIVE	DSBGA	YFQ	4	250	RoHS & Green	SNAGCU	Level-1-260C-UNLIM	-55 to 150		<a href="#">Samples</a>

(1) The marketing status values are defined as follows:

**ACTIVE:** Product device recommended for new designs.

**LIFEBUY:** TI has announced that the device will be discontinued, and a lifetime-buy period is in effect.

**NRND:** Not recommended for new designs. Device is in production to support existing customers, but TI does not recommend using this part in a new design.

**PREVIEW:** Device has been announced but is not in production. Samples may or may not be available.

**OBSELETE:** TI has discontinued the production of the device.

(2) **RoHS:** TI defines "RoHS" to mean semiconductor products that are compliant with the current EU RoHS requirements for all 10 RoHS substances, including the requirement that RoHS substance do not exceed 0.1% by weight in homogeneous materials. Where designed to be soldered at high temperatures, "RoHS" products are suitable for use in specified lead-free processes. TI may reference these types of products as "Pb-Free".

**RoHS Exempt:** TI defines "RoHS Exempt" to mean products that contain lead but are compliant with EU RoHS pursuant to a specific EU RoHS exemption.

**Green:** TI defines "Green" to mean the content of Chlorine (Cl) and Bromine (Br) based flame retardants meet JS709B low halogen requirements of <=1000ppm threshold. Antimony trioxide based flame retardants must also meet the <=1000ppm threshold requirement.

(3) MSL, Peak Temp. - The Moisture Sensitivity Level rating according to the JEDEC industry standard classifications, and peak solder temperature.

(4) There may be additional marking, which relates to the logo, the lot trace code information, or the environmental category on the device.

(5) Multiple Device Markings will be inside parentheses. Only one Device Marking contained in parentheses and separated by a "-" will appear on a device. If a line is indented then it is a continuation of the previous line and the two combined represent the entire Device Marking for that device.

(6) Lead finish/Ball material - Orderable Devices may have multiple material finish options. Finish options are separated by a vertical ruled line. Lead finish/Ball material values may wrap to two lines if the finish value exceeds the maximum column width.

**Important Information and Disclaimer:**The information provided on this page represents TI's knowledge and belief as of the date that it is provided. TI bases its knowledge and belief on information provided by third parties, and makes no representation or warranty as to the accuracy of such information. Efforts are underway to better integrate information from third parties. TI has taken and



continues to take reasonable steps to provide representative and accurate information but may not have conducted destructive testing or chemical analysis on incoming materials and chemicals. TI and TI suppliers consider certain information to be proprietary, and thus CAS numbers and other limited information may not be available for release.

In no event shall TI's liability arising out of such information exceed the total purchase price of the TI part(s) at issue in this document sold by TI to Customer on an annual basis.

YFQ0004

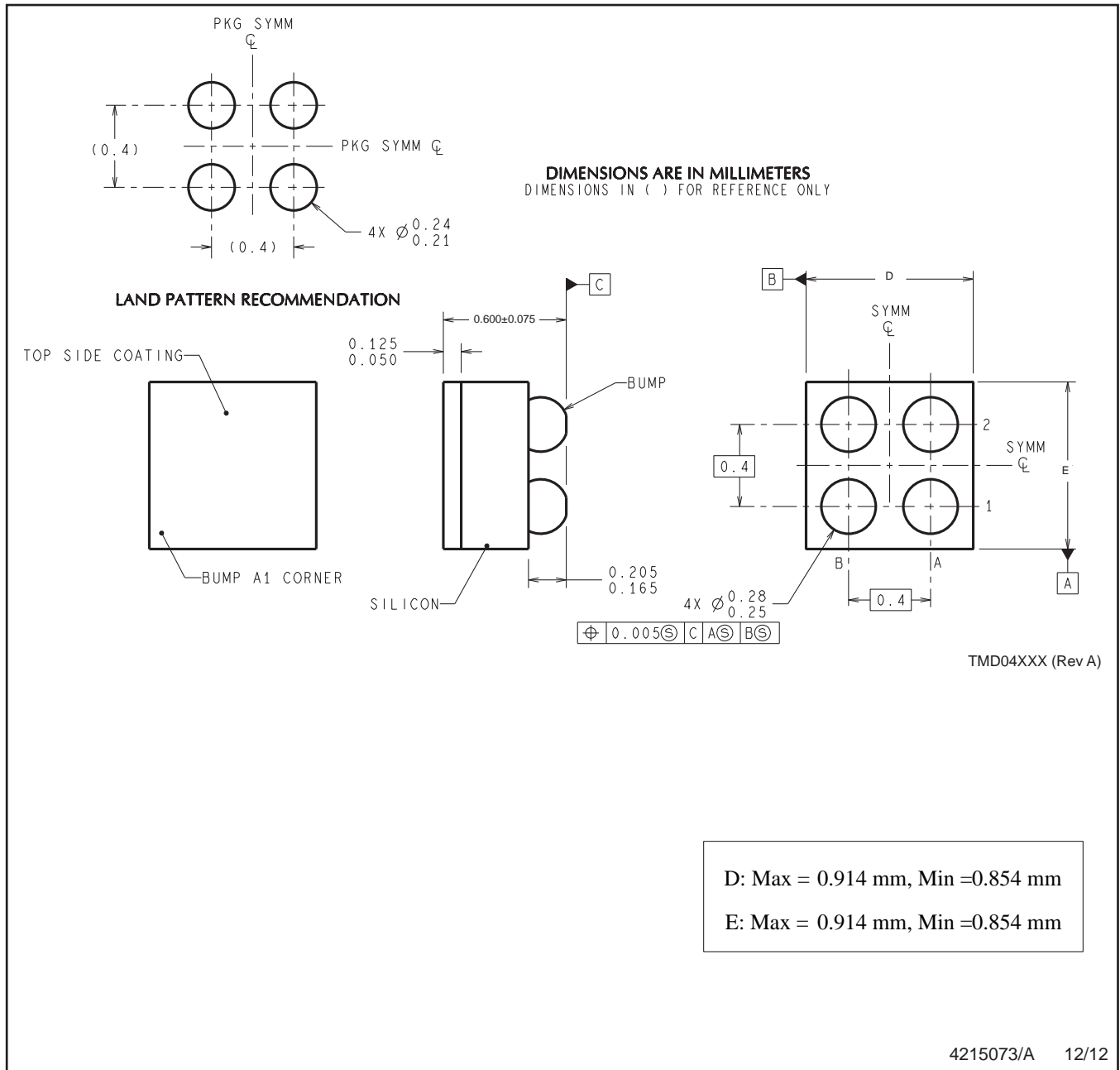

NOTES: A. All linear dimensions are in millimeters. Dimensioning and tolerancing per ASME Y14.5M-1994.  
 B. This drawing is subject to change without notice.

## 重要声明和免责声明

TI“按原样”提供技术和可靠性数据（包括数据表）、设计资源（包括参考设计）、应用或其他设计建议、网络工具、安全信息和其他资源，不保证没有瑕疵且不做任何明示或暗示的担保，包括但不限于对适销性、某特定用途方面的适用性或不侵犯任何第三方知识产权的暗示担保。

这些资源可供使用 TI 产品进行设计的熟练开发人员使用。您将自行承担以下全部责任：(1) 针对您的应用选择合适的 TI 产品，(2) 设计、验证并测试您的应用，(3) 确保您的应用满足相应标准以及任何其他功能安全、信息安全、监管或其他要求。

这些资源如有变更，恕不另行通知。TI 授权您仅可将这些资源用于研发本资源所述的 TI 产品的应用。严禁对这些资源进行其他复制或展示。您无权使用任何其他 TI 知识产权或任何第三方知识产权。您应全额赔偿因在这些资源的使用中对 TI 及其代表造成的任何索赔、损害、成本、损失和债务，TI 对此概不负责。

TI 提供的产品受 [TI 的销售条款](#) 或 [ti.com](#) 上其他适用条款/TI 产品随附的其他适用条款的约束。TI 提供这些资源并不会扩展或以其他方式更改 TI 针对 TI 产品发布的适用的担保或担保免责声明。

TI 反对并拒绝您可能提出的任何其他或不同的条款。

邮寄地址：Texas Instruments, Post Office Box 655303, Dallas, Texas 75265

Copyright © 2022，德州仪器 (TI) 公司