

Low Consumption Current Regulators

■ GENERAL DESCRIPTION

XC6206J series are highly precise, low noise, positive voltage LDO regulators manufactured using CMOS processes. The series achieves very low supply current, 1.0 μA (TYP.) and consists of a reference voltage source, an error amplifier, current limit circuit, and a phase compensation circuit plus a driver transistor.

The series is also compatible with low ESR ceramic capacitors (C_L), which give added output stability.

The current limiter's fold-back circuit also operates as a short protect for the output current limiter and the output pin.

■ APPLICATIONS

- Mobile devices / terminals
- Communication equipment
(Bluetooth, Wi-Fi, GPS etc)
- Module (Communication, Camera, etc)
- Cell phones
- Smartphones

■ FEATURES

| | |
|--------------------------------------|--|
| Maximum Output Current | : 200mA |
| Dropout Voltage | : 200mV@ $I_{OUT}=100\text{mA}$ ($V_{OUT}=3.0\text{V}$) |
| Operating Voltage Range | : 1.5V ~ 6.0V |
| Output Voltage | : 0.9 ~ 4.0V (0.1V increments) |
| Low Consumption Current | : 1.0 μA (TYP.) |
| Protection Circuit | : Current Limit 300mA (TYP.) Short Circuit Protection 50mA (TYP.) |
| External Capacitor | : 0.1 μF ~ 1.0 μF |
| Operating Ambient Temperature | : -40°C ~ +85°C |
| Package | : SOT-25-02 |
| Environmentally Friendly | : EU RoHS Compliant, Pb Free |

■ TYPICAL APPLICATION CIRCUIT

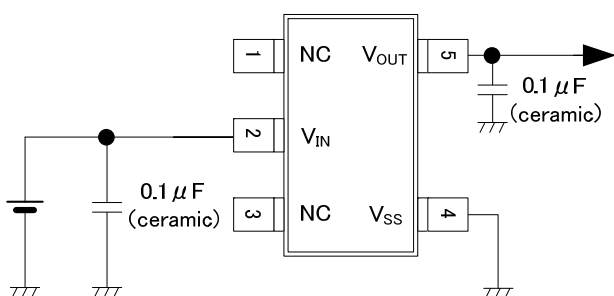

■ TYPICAL PERFORMANCE CHARACTERISTICS

- Supply Current vs. Input Voltage

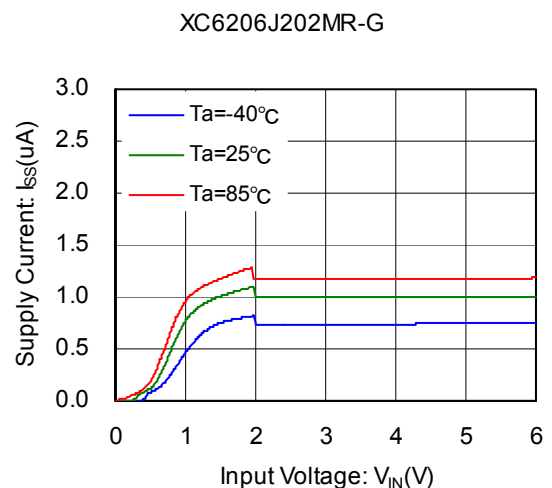

XC6206J Series

■ BLOCK DIAGRAM

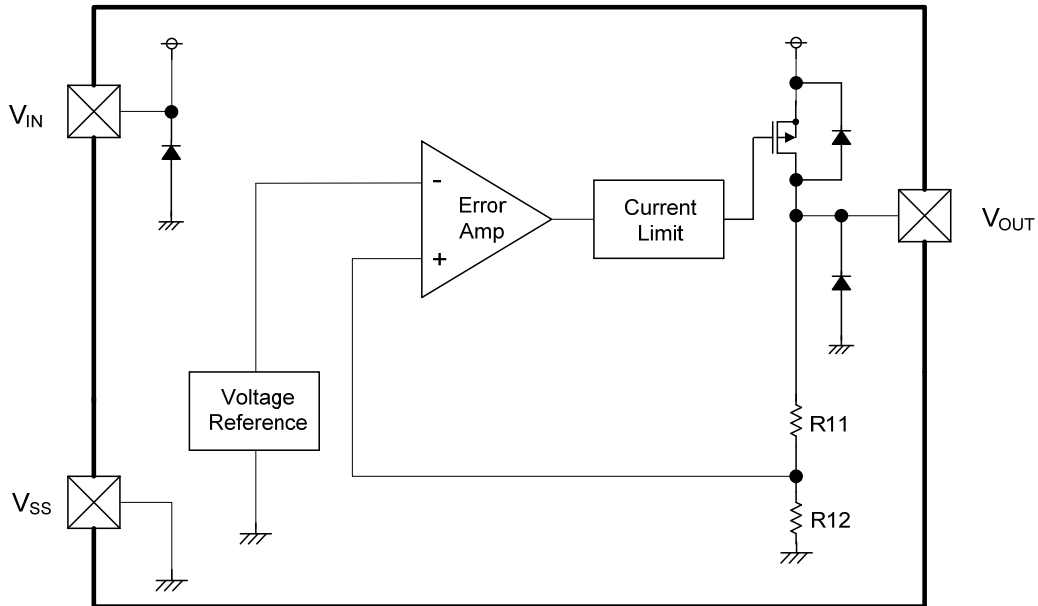

* Diodes inside the circuits are ESD protection diodes and parasitic diodes.

■ PRODUCT CLASSIFICATION

● Ordering Information

XC6206J①②③④⑤-⑥

| DESIGNATOR | ITEM | SYMBOL | DESCRIPTION |
|------------|-------------------------|--------|--|
| ①② | Output Voltage | 09~40 | Output voltage ex.) 3.0V ⇒ ①= 3, ②= 0 |
| ③ | Output Voltage Accuracy | 2 | $\pm 2\%$ ($V_{OUT(T)} \geq 1.5V$), $\pm 30mV$ ($V_{OUT(T)} < 1.5V$) |
| ④⑤-⑥ (*) | Package (Order Unit) | MR-G | SOT-25-02 (3,000/Reel) |

(*) The "-G" suffix denotes Halogen and Antimony free as well as being fully EU RoHS compliant.

■ PIN CONFIGURATION

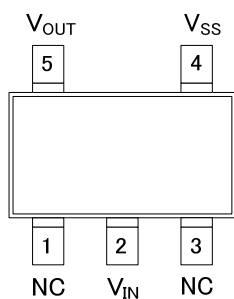

SOT-25-02
(TOP VIEW)

■ PIN ASSIGNMENT

| PIN NUMBER | PIN NAME | FUNCTION |
|------------|------------------|--------------------|
| SOT-25-02 | | |
| 1 | NC | No Connection |
| 2 | V _{IN} | Power Supply Input |
| 3 | NC | No Connection |
| 4 | V _{SS} | Ground |
| 5 | V _{OUT} | Output |

■ ABSOLUTE MAXIMUM RATINGS

T_a=25°C

| PARAMETER | SYMBOL | RATINGS | UNITS |
|----------------------------------|------------------|---|-------|
| Input Voltage | V _{IN} | - 0.3 ~ + 7.0 | V |
| Output Current | I _{OUT} | 500 ^(*) | mA |
| Output Voltage | V _{OUT} | - 0.3 ~ V _{IN} + 0.3 or +7.0 ^(**) | V |
| Power Dissipation ^(*) | SOT-25-02 Pd | 250 | mW |
| Operating Ambient Temperature | T _{opr} | -40~+85 | °C |
| Storage Temperature | T _{stg} | -55~+125 | °C |

All voltages are described based on V_{SS}.

^(*) I_{OUT} ≤ Pd / (V_{IN} - V_{OUT})

^(**) The maximum value should be either V_{IN}+0.3 or +7.0 in the lowest.

ELECTRICAL CHARACTERISTICS

Ta=25°C

| PARAMETER | SYMBOL | CONDITIONS | MIN. | TYP. | MAX. | UNITS | CIRCUIT |
|--|---|---|---------------------|---------------------|---------------------|--------|---------|
| Output Voltage | V _{OUT(E)} ^(*2) | V _{IN} =V _{OUT(T)} ^(*1) +1.0V、I _{OUT} =1mA | E-1 ^(*4) | V _{OUT(T)} | E-1 ^(*4) | V | ① |
| Load Regulation | ΔV _{OUT} | 0.9V ≤ V _{OUT(T)} < 1.3V V _{IN} =V _{OUT(T)} +1.5V 1mA ≤ I _{OUT} ≤ 100mA | - | 15 | 70 | mV | ① |
| | | V _{OUT(T)} ≥ 1.3V V _{IN} =V _{OUT(T)} +1.0V 1mA ≤ I _{OUT} ≤ 100mA | | | | | |
| Dropout Voltage1 | V _{dif1} ^(*3) | I _{OUT} =30mA | - | E-2 ^(*5) | | mV | ① |
| Dropout Voltage2 | V _{dif2} ^(*3) | I _{OUT} =100mA | - | E-3 ^(*5) | | mV | ① |
| Supply Current | I _{SS} | V _{IN} =V _{OUT(T)} +1.0V | - | 1.0 | 5.0 | μA | ② |
| Line Regulation | ΔV _{OUT} / (ΔV _{IN} ·V _{OUT}) | V _{OUT(T)} =0.9V 1.5V ≤ V _{IN} ≤ 6.0V I _{OUT} =1mA | - | 0.05 | 0.15 | %V | ① |
| | | V _{OUT(T)} ≥ 1.0V V _{OUT(T)} +0.5V ≤ V _{IN} ≤ 6.0V I _{OUT} =1mA | | | | | |
| Input Voltage | V _{IN} | - | 1.5 | - | 6 | V | - |
| Output Voltage Temperature Characteristics | ΔV _{OUT} / (ΔT _{opr} ·V _{OUT}) | V _{IN} =V _{OUT(T)} +1.0V I _{OUT} =1mA -40°C ≤ T _{opr} ≤ 85°C | - | ±100 | - | ppm/°C | ① |
| Current Limit | I _{LIM} | V _{OUT} =V _{OUT(E)} ×0.95 0.9V ≤ V _{OUT(T)} ≤ 1.5V V _{IN} =2.6V | 200 | 300 | - | mA | ① |
| | | V _{OUT} =V _{OUT(E)} ×0.95 V _{OUT(T)} ≥ 1.6V V _{IN} =V _{OUT(T)} +1.0V | 250 | 300 | - | | |
| Short Current | I _{SHORT} | V _{IN} =V _{OUT(T)} +1.0V、V _{OUT} =0V | - | 50 | - | mA | ① |

Notes:

^(*1) V_{OUT(T)} is Nominal output voltage

^(*2) V_{OUT(E)} is Effective output voltage

(i.e. the output voltage when "(V_{OUT(T)} + 1.0V)" is provided at the V_{IN} pin while maintaining a certain I_{OUT} value.

^(*3) V_{dif}={V_{IN1}-V_{OUT1}}

V_{IN1} is the input voltage when V_{OUT1} appears at the V_{OUT} pin while input voltage is gradually decreased.

V_{OUT1} is the voltage equal to 98% of the normal output voltage when amply stabilized V_{OUT(T)}+1.0V is input at the V_{IN} pin.

^(*4) Refer to the VOLTAGE CHART.

^(*5) V_{OUT(T)} ≥ 1.5V → Accuracy ±2.0%

V_{OUT(T)} < 1.5V → MIN : V_{OUT(T)} - 30mV, MAX : V_{OUT(T)} + 30mV.

■ **VOLTAGE CHART**

Ta=25°C

| NOMINAL OUTPUT VOLTAGE | E-1 | | E-2 | | E-3 | |
|------------------------------|--------------------------|-------|-----------------------------|------|-----------------------------|------|
| | OUTPUT VOLTAGE (V) | | DROPOUT VOLTAGE1 (mV) | | DROPOUT VOLTAGE2 (mV) | |
| | V _{OUT(E)} | | V _{dif1} | | V _{dif2} | |
| V _{OUT(T)} | MIN. | MAX. | TYP. | MAX. | TYP. | MAX. |
| 0.9 | 0.870 | 0.930 | 460 | 900 | 850 | 1450 |
| 1.0 | 0.970 | 1.030 | 370 | 760 | 750 | 1300 |
| 1.1 | 1.070 | 1.130 | 300 | 650 | 680 | 1190 |
| 1.2 | 1.170 | 1.230 | 240 | 540 | 600 | 1070 |
| 1.3 | 1.270 | 1.330 | 190 | 420 | 530 | 950 |
| 1.4 | 1.370 | 1.430 | 160 | 340 | 470 | 840 |
| 1.5 | 1.470 | 1.530 | | | | |
| 1.6 | 1.568 | 1.632 | | | | |
| 1.7 | 1.666 | 1.734 | 110 | 200 | 350 | 610 |
| 1.8 | 1.764 | 1.836 | | | | |
| 1.9 | 1.862 | 1.938 | | | | |
| 2.0 | 1.960 | 2.040 | 90 | 150 | 290 | 480 |
| 2.1 | 2.058 | 2.142 | | | | |
| 2.2 | 2.156 | 2.244 | | | | |
| 2.3 | 2.254 | 2.346 | | | | |
| 2.4 | 2.352 | 2.448 | | | | |
| 2.5 | 2.450 | 2.550 | 70 | 120 | 240 | 370 |
| 2.6 | 2.548 | 2.652 | | | | |
| 2.7 | 2.646 | 2.754 | | | | |
| 2.8 | 2.744 | 2.856 | | | | |
| 2.9 | 2.842 | 2.958 | | | | |
| 3.0 | 2.940 | 3.060 | 60 | 100 | 200 | 320 |
| 3.1 | 3.038 | 3.162 | | | | |
| 3.2 | 3.136 | 3.264 | | | | |
| 3.3 | 3.234 | 3.366 | | | | |
| 3.4 | 3.332 | 3.468 | | | | |
| 3.5 | 3.430 | 3.570 | | | | |
| 3.6 | 3.528 | 3.672 | | | | |
| 3.7 | 3.626 | 3.774 | | | | |
| 3.8 | 3.724 | 3.876 | | | | |
| 3.9 | 3.822 | 3.978 | | | | |
| 4.0 | 3.920 | 4.080 | | | | |

TEST CIRCUITS

● Circuit ①

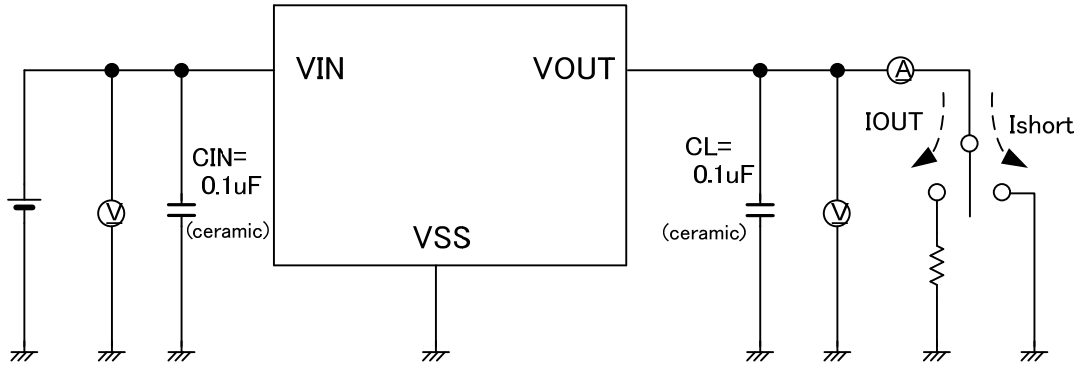

● Circuit ②

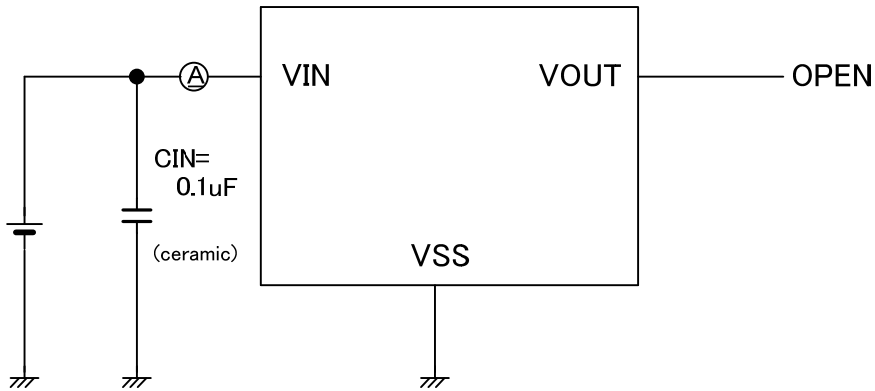

■ OPERATIONAL EXPLANATION

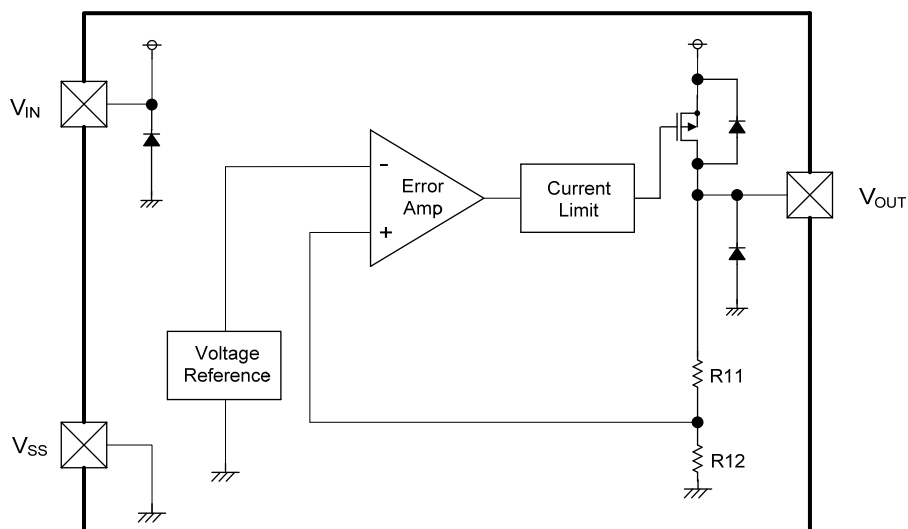

The XC6206J series consists of a reference voltage source, an error amplifier, current limit circuit, and a phase compensation circuit plus a driver transistor. The voltage, divided by resistors R11 & R12, which are connected to the V_{OUT} pin is compared with the internal reference voltage by the error amplifier. The P-channel MOSFET, which is connected to the V_{OUT} pin, is then driven by the subsequent output signal. The output voltage at the V_{OUT} pin is controlled & stabilized by negative feedback. The current limit circuit and short circuit protection operate in relation to the level of output current.

<Current Limit, Short-Circuit Protection>

The XC6206J series includes a current limit circuit, which aid the operations of the current limiter and short-circuit protection. When the load current reaches the current limit level (300mA, TYP.), the current limiter circuit operates and output voltage drops. The circuit operates to decrease the current limit as the load impedance decreases further and the output voltage drops. When the output pin is shorted, a current of about 50mA flows.

■ NOTES ON USE

1. For temporary, transitional voltage drop or voltage rising phenomenon, the IC is liable to malfunction should the ratings be exceeded.
2. Where wiring impedance is high, operations may become unstable due to noise and/or phase lag depending on output current.
3. The XC6206J series oscillates normally even without an input capacitor, C_{IN} , or an output capacitor, C_L , because the series compensates by the phase compensation circuit. However, when an input wiring is long, about $0.1\ \mu\text{F}$ to $1.0\ \mu\text{F}$ of the input capacitor, C_{IN} , is required for stabilizing input. When an under-shoot or over-shoot is large at transient response, about $0.1\ \mu\text{F}$ to $1.0\ \mu\text{F}$ of output capacitor, which prevents output fluctuation occurred by load fluctuation, is also recommended. Please wire the input capacitor (C_{IN}) and the output capacitor (C_L) as close to the IC as possible. Please wire the input capacitor (C_{IN}) and the output capacitor (C_L) as close to the IC as possible.
4. When the input voltage starts from 0V, over-shoot may occur because of the slope of the input rising. In order to avoid the over-shoot, please use the IC by setting the slope of the input rising within 0.1V/ms.
5. Torex places an importance on improving our products and their reliability.
We request that users incorporate fail-safe designs and post-aging prevention treatment when using Torex products in their systems.

■ TYPICAL PERFORMANCE CHARACTERISTICS

(1) Output Voltage vs. Output Current

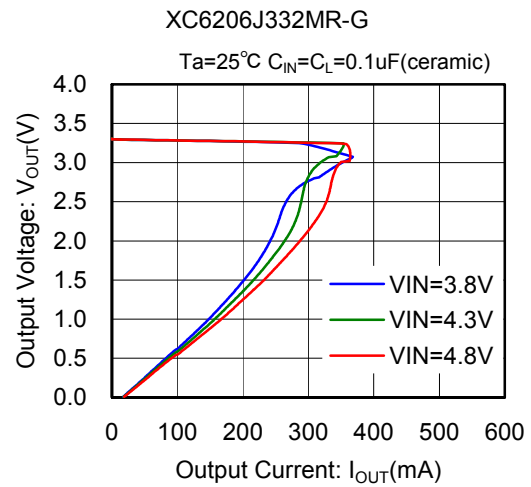
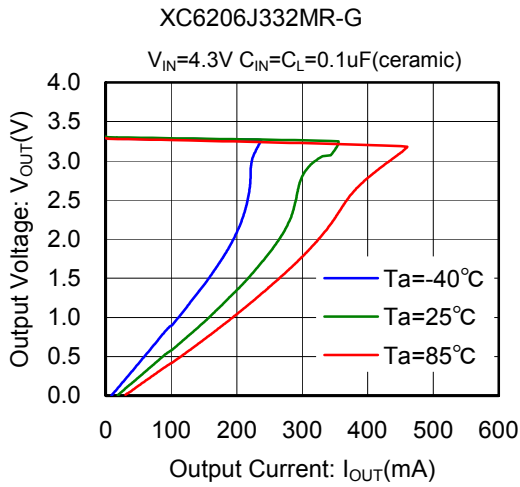

(2) Output Voltage vs. Input Voltage

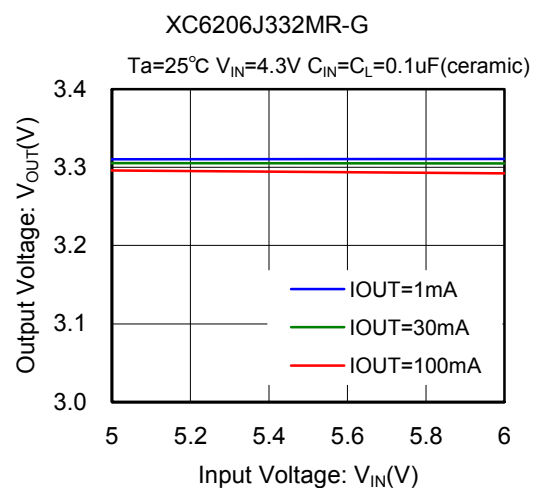
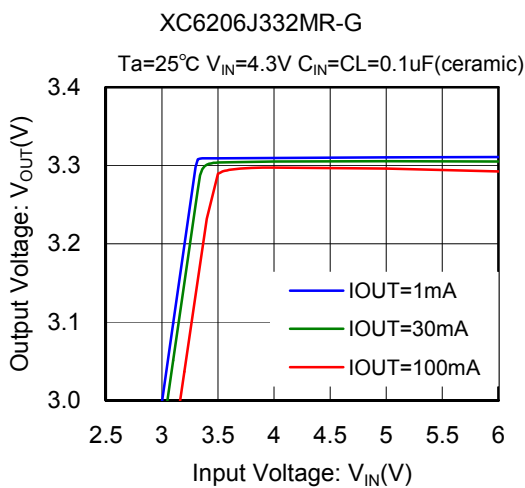

(3) Dropout Voltage vs. Output Current

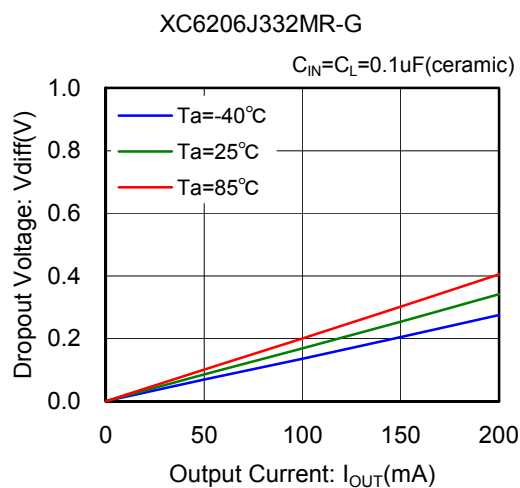

(4) Supply Current vs. Input Voltage

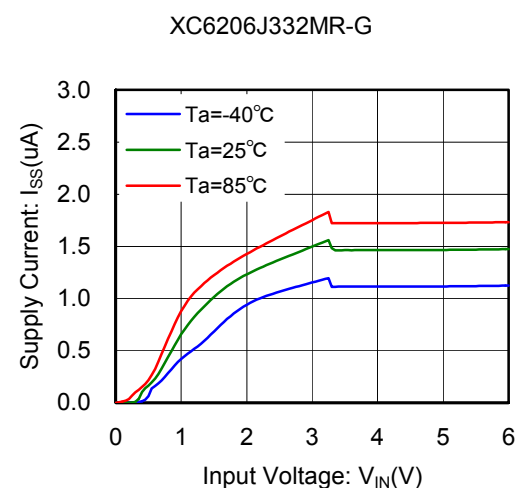

XC6206J Series

TYPICAL PERFORMANCE CHARACTERISTICS (Continued)

(5) Output Voltage vs. Ambient Temperature

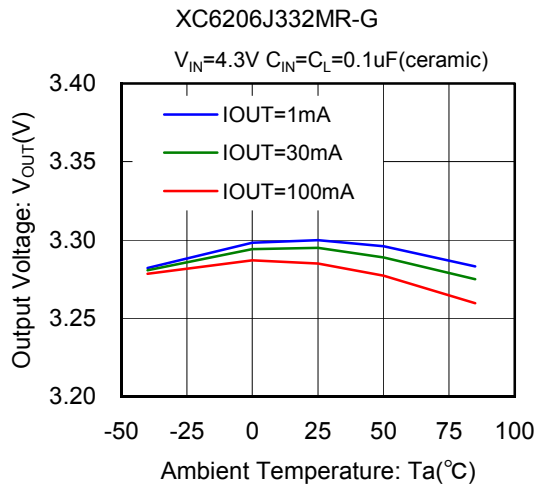

(6) Supply Current vs. Ambient Temperature

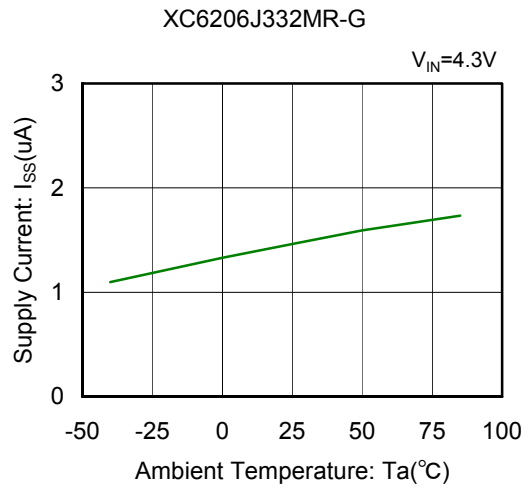

■ TYPICAL PERFORMANCE CHARACTERISTICS (Continued)

(7) Input Transient Response

XC6206J332MR-G
tr=tf=5us I_{OUT}=1mA C_L=0.1uF(ceramic) Ta=25°C

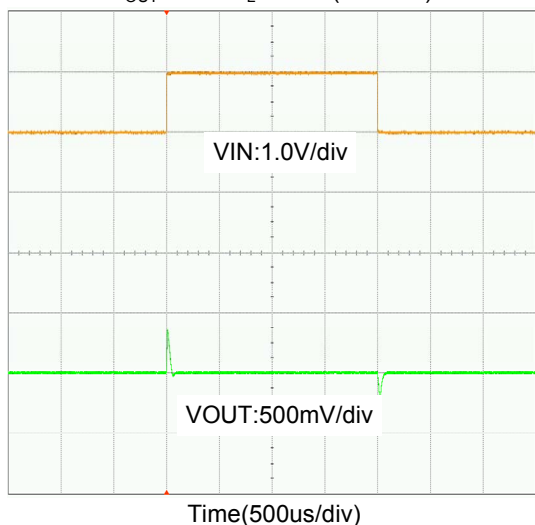

XC6206J332MR-G
tr=tf=5us I_{OUT}=1mA C_L=1.0uF(ceramic) Ta=25°C

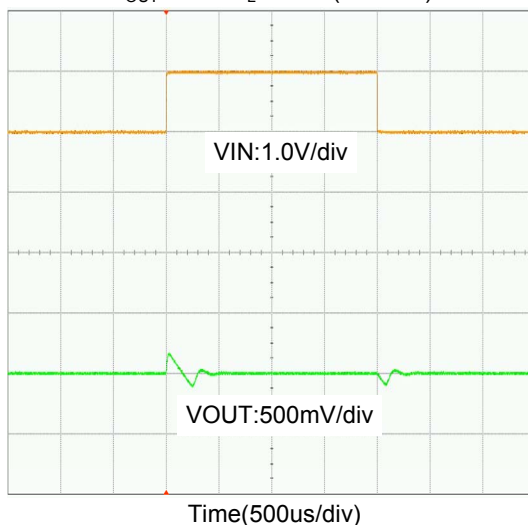

XC6206J332MR-G
tr=tf=5us I_{OUT}=50mA C_L=0.1uF(ceramic) Ta=25°C

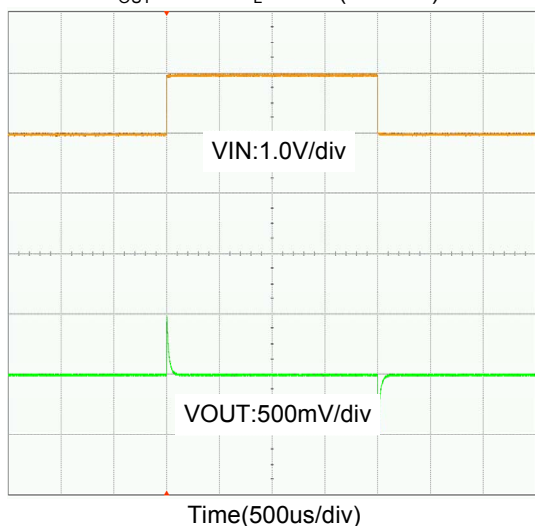

XC6206J332MR-G
tr=tf=5us I_{OUT}=50mA C_L=1.0uF(ceramic) Ta=25°C

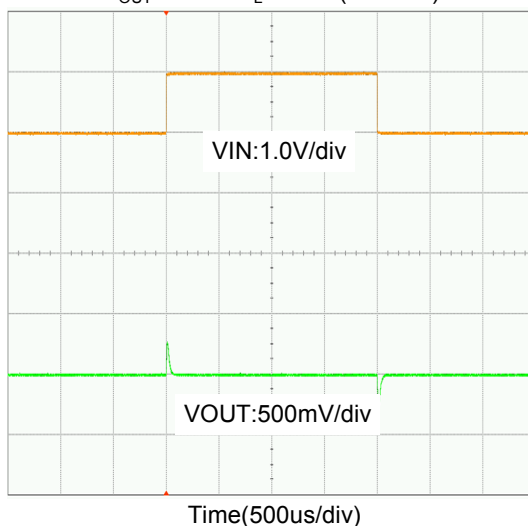

XC6206J332MR-G
tr=tf=5us I_{OUT}=100mA C_L=0.1uF(ceramic) Ta=25°C

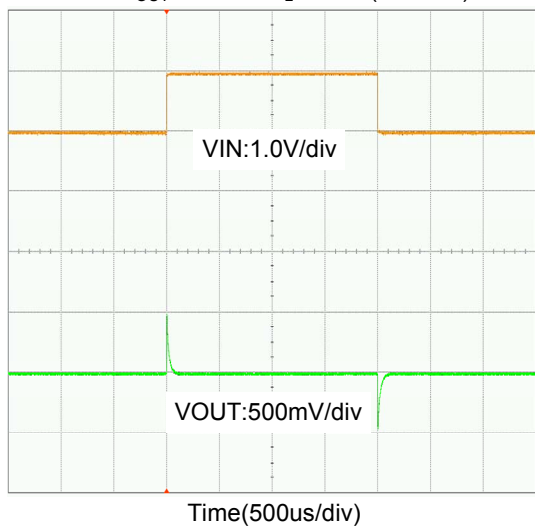

XC6206J332MR-G
tr=tf=5us I_{OUT}=100mA C_L=1.0uF(ceramic) Ta=25°C

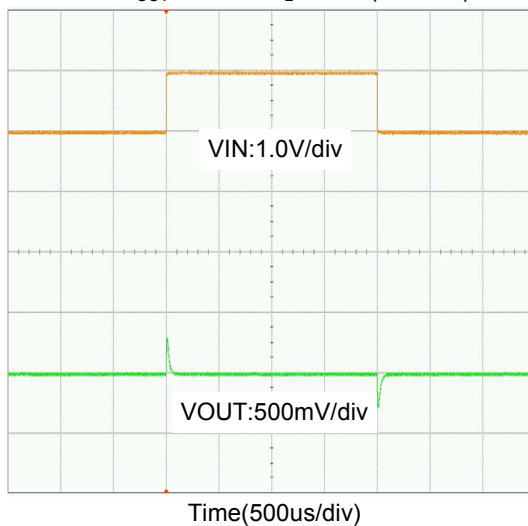

TYPICAL PERFORMANCE CHARACTERISTICS (Continued)

(8) Load Transient Response

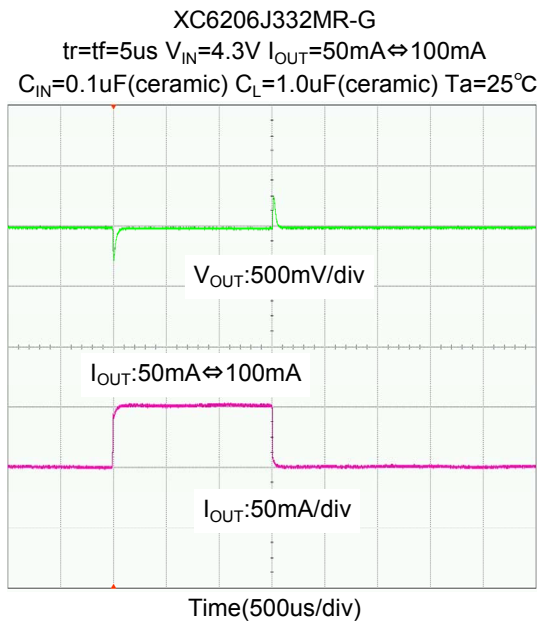
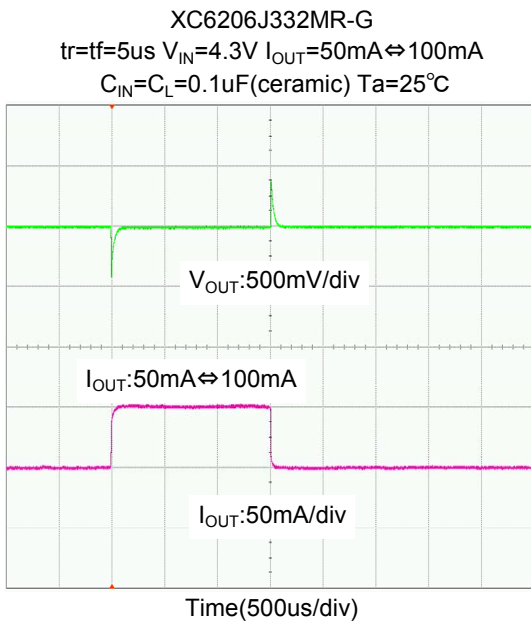
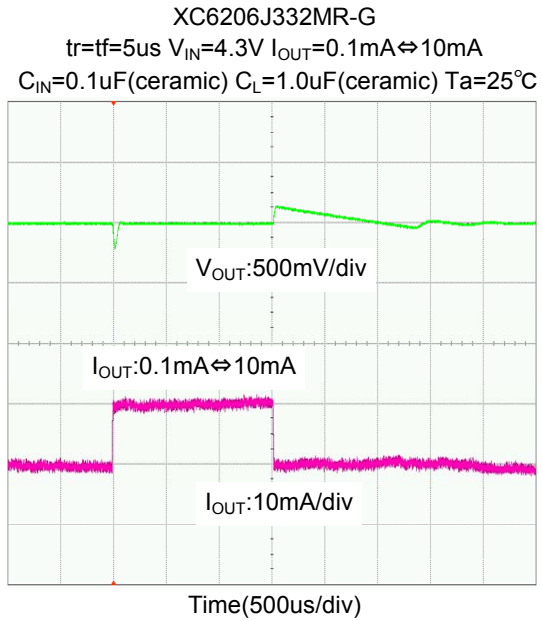
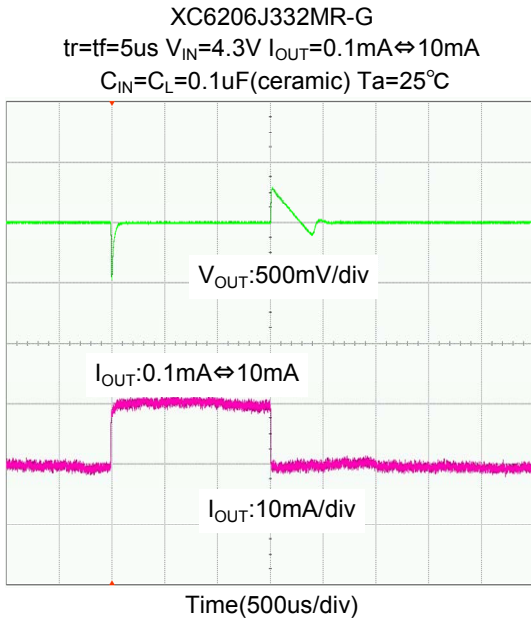

■ TYPICAL PERFORMANCE CHARACTERISTICS (Continued)

(9) Input Turn-On Transient Response

XC6206J332MR-G
tr=tf=5us I_{OUT}=1mA C_L=0.1uF(ceramic) Ta=25°C

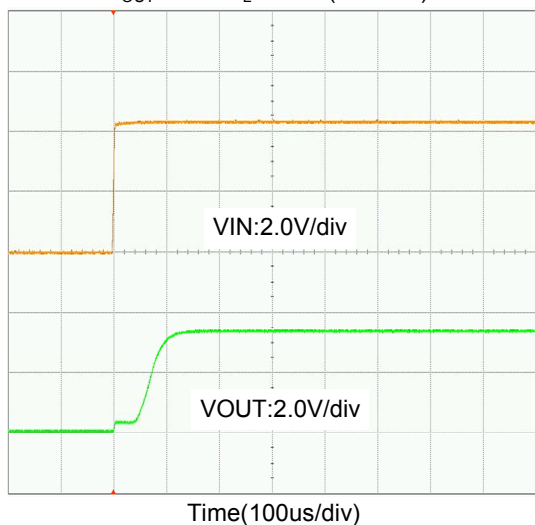

XC6206J332MR-G
tr=tf=5us I_{OUT}=50mA C_L=0.1uF(ceramic) Ta=25°C

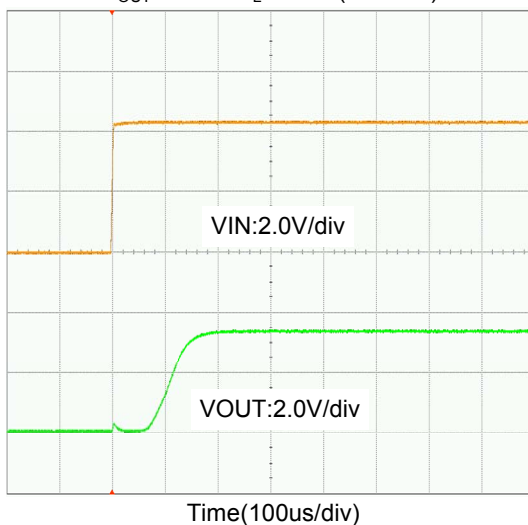

XC6206J332MR-G
tr=tf=5us I_{OUT}=100mA C_L=0.1uF(ceramic) Ta=25°C

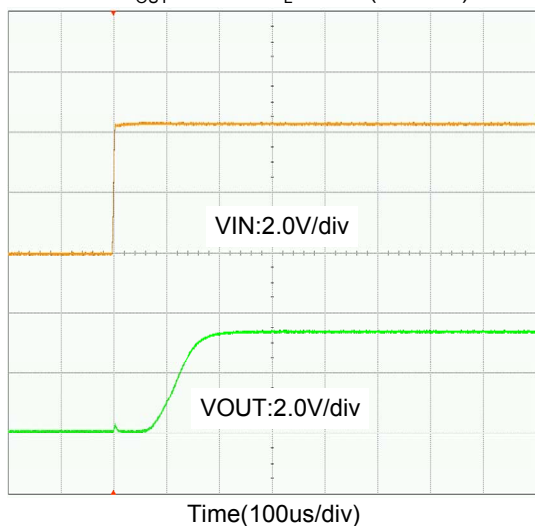

(10) Ripple Rejection Rate

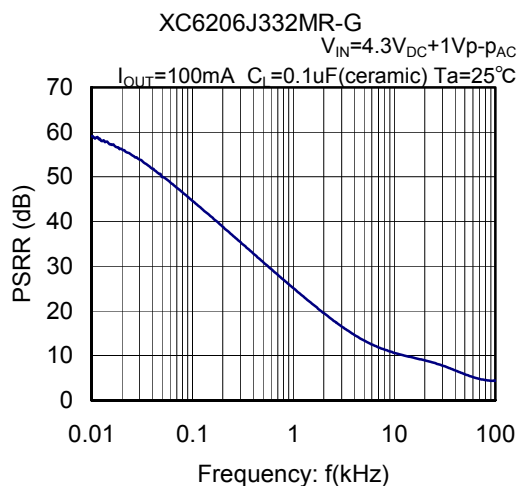

XC6206J Series

PACKAGING INFORMATION

●SOT-25-02 (unit: mm)

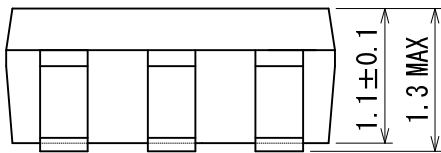
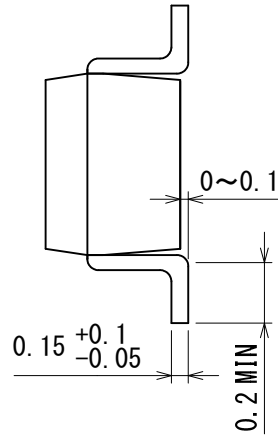
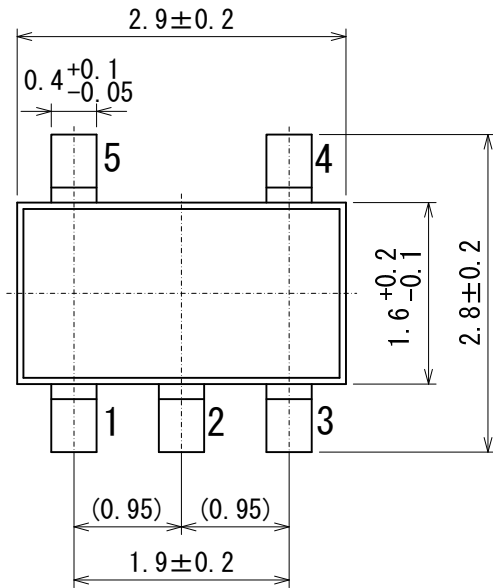

MARKING RULE

SOT-25-02 (Under dot)

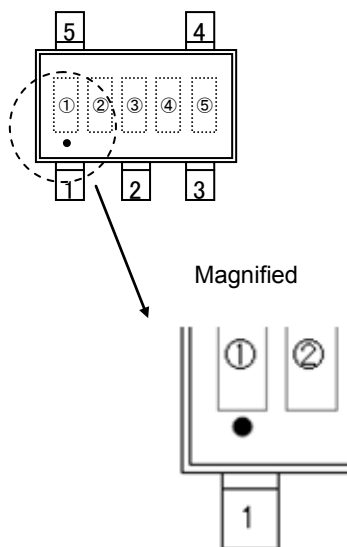

* SOT-25-02 with the under-dot marking is used.

① represents products series

| MARK | PRODUCT SERIES |
|------|----------------|
| A | XC6206J*****-G |

② represents type of regulator

| MARK | OUTPUT VOLTAGE (V) | PRODUCT SERIES |
|------|---|----------------|
| 1 | 0.9/1.0/1.2/1.5/1.8/2.0/2.5/2.8/3.0/3.3/3.5/3.6/3.7/3.8/3.9/4.0 | XC6206J*****-G |
| 2 | 1.1/1.3/1.4/1.6/1.7/1.9/2.1/2.2/2.3/2.4/2.6/2.7/2.9/3.1/3.2/3.4 | |

③ represents output voltage

| MARK | OUTPUT VOLTAGE (V) | | MARK | OUTPUT VOLTAGE (V) | |
|------|--------------------|---------|------|--------------------|---------|
| | MARK②=1 | MARK②=2 | | MARK②=1 | MARK②=2 |
| A | 1.2 | 1.4 | L | 3.6 | 2.6 |
| B | 1.5 | 1.6 | M | 3.5 | 2.7 |
| C | 1.8 | 1.7 | N | 3.7 | 2.9 |
| D | 2.0 | 1.9 | P | 3.8 | 3.1 |
| E | 2.5 | 2.1 | R | 3.9 | 3.2 |
| F | 2.8 | 2.2 | S | 4.0 | 3.4 |
| H | 3.0 | 2.3 | T | 0.9 | 1.1 |
| K | 3.3 | 2.4 | U | 1.0 | 1.3 |

④,⑤ represents production lot number

01~09, 0A~0Z, 11~9Z, A1~A9, AA~AZ, B1~ZZ in order.

(G, I, J, O, Q, W excluded)

*No character inversion used.

1. The product and product specifications contained herein are subject to change without notice to improve performance characteristics. Consult us, or our representatives before use, to confirm that the information in this datasheet is up to date.
2. The information in this datasheet is intended to illustrate the operation and characteristics of our products. We neither make warranties or representations with respect to the accuracy or completeness of the information contained in this datasheet nor grant any license to any intellectual property rights of ours or any third party concerning with the information in this datasheet.
3. Applicable export control laws and regulations should be complied and the procedures required by such laws and regulations should also be followed, when the product or any information contained in this datasheet is exported.
4. The product is neither intended nor warranted for use in equipment of systems which require extremely high levels of quality and/or reliability and/or a malfunction or failure which may cause loss of human life, bodily injury, serious property damage including but not limited to devices or equipment used in 1) nuclear facilities, 2) aerospace industry, 3) medical facilities, 4) automobile industry and other transportation industry and 5) safety devices and safety equipment to control combustions and explosions. Do not use the product for the above use unless agreed by us in writing in advance.
5. Although we make continuous efforts to improve the quality and reliability of our products; nevertheless Semiconductors are likely to fail with a certain probability. So in order to prevent personal injury and/or property damage resulting from such failure, customers are required to incorporate adequate safety measures in their designs, such as system fail safes, redundancy and fire prevention features.
6. Our products are not designed to be Radiation-resistant.
7. Please use the product listed in this datasheet within the specified ranges.
8. We assume no responsibility for damage or loss due to abnormal use.
9. All rights reserved. No part of this datasheet may be copied or reproduced unless agreed by Torex Semiconductor Ltd in writing in advance.

TOREX SEMICONDUCTOR LTD.