

# 产品承认书

## SPECIFICATION FOR APPROVAL

CUSTOMER:

CUSTOMER P/N:

JXD P/N.:

G2436S

DESCRIPTION:

1000 BASE-T MAGNETICS MODULES

REF NO:

QTC-003

REV/NO:

A/0

DATE:

2021/5/26

ATTACHMENT:

■ SPECIFICATION

■ SAMPLE Q'TY OF SAMPLES \_\_\_\_\_ PCS

	√	CUSTOMER'S SIGNATURE	REMARK
FULL APPROVED			
CONDITIONAL APPROVED			
REJECTED			



深圳磁联达电子有限公司

Shenzhen CND-TEK Electronics Co. Ltd.

公司地址: 深圳市南山区西丽镇牛成路221大厦

TEL: 86-755-29016433 FAX: 0755-27652977

Email: cd001@cd-tek.com

Http: //www.cd-tek.com



## 1. FEATURES:

- 1.1 Designed for long haul Gigabit Ethernet 100/1000 Base-T, full duplex applications.
- 1.2 Supports four pairs of category 5 UTP cable,Cable interface for isolation and low common mode emissions.
- 1.3 Low profile Surface Mount Packaging designed for Hi-Temp Reflow Process
- 1.4 Compliant with IEEE 802.3af standard for 1000 Base-T,Designed to support 1:1 Turns Ratio Transceivers.
- 1.5 DC Line Current : 350mA Max @ 57V
- 1.6 Operating Temperature range: -40°C~+85°C
- 1.7 Storage temperature range: -45°C~+125°C

## 2. DIMENSIONS & MARKING

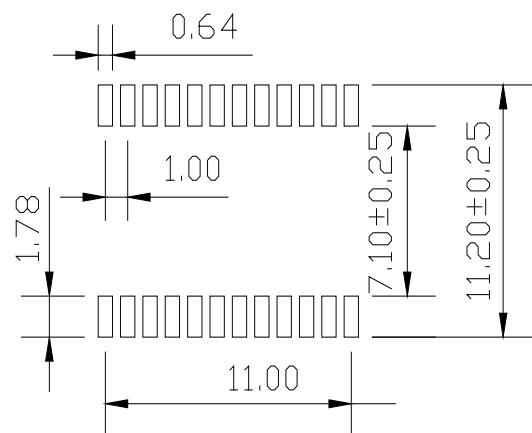
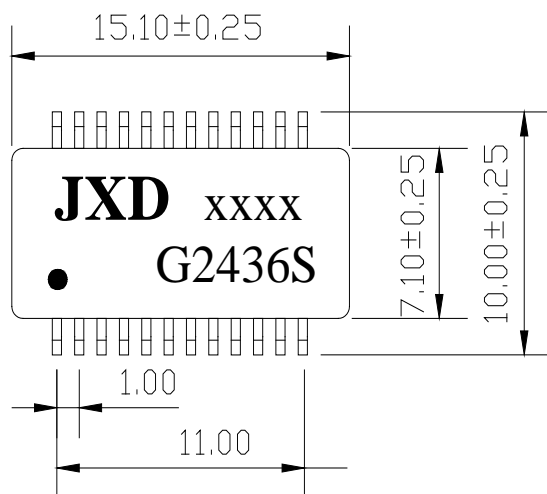

**Recommended Land Pattern**

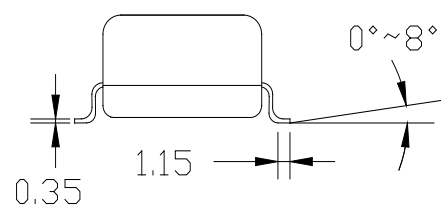
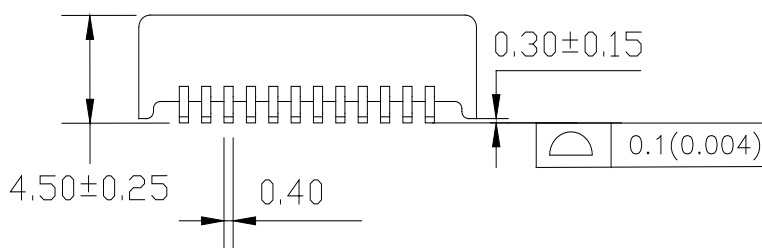

- Note:**
- 1、 Dimension: mm
  - 2、 Unless otherwise specified,all tolerances are:  $\pm 0.05$ mm

DRAWN BY:		CHECKED BY:		APPROVED BY:		CUSTOMER:	
						PART NO. : G2436S	
		深圳磁联达电子有限公司				REV.: A/0	
		Shenzhen CND-TEK Electronics Co. Ltd.				PAGE: 2 OF 4	

### 3. SCHEMATICS:

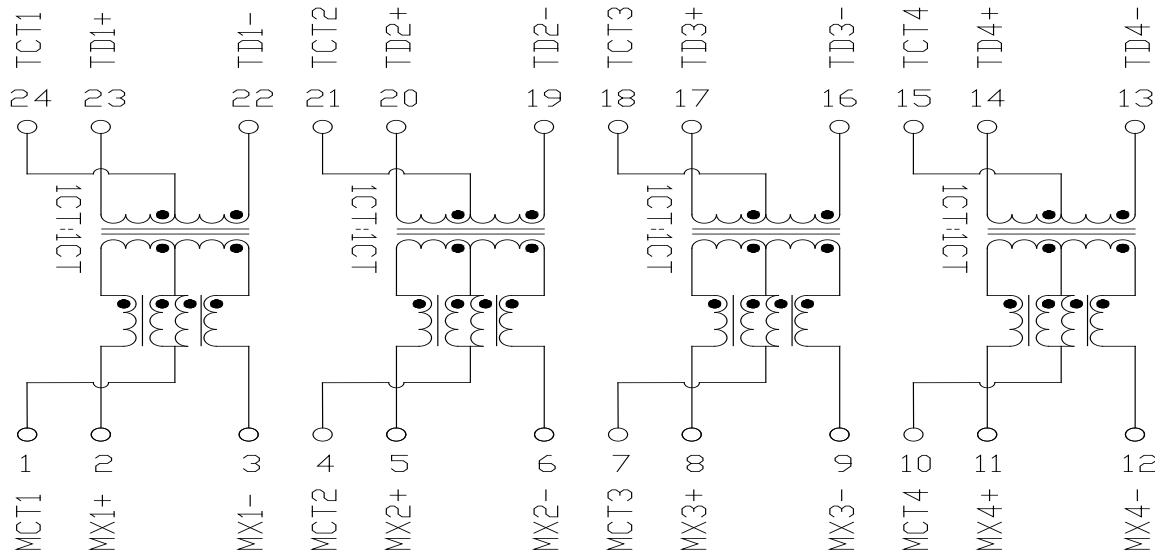

### 4. ELECTRICAL SPECIFICATIONS @25°C

4.1 OCL : 350  $\mu$ H Min. @ 100 KHz, 100mV with 8mA DC Bias

4.2 Leakage Inductance: 0.5  $\mu$ H Max. @ 100KHz, 0.2V

4.3 Cw/w: 28 pF Max. @ 100KHz, 0.2V

4.4 DCR: 0.9 Max.

4.5 Turns Ratio( $\pm$ 5%): 1CT:1(TX), 1CT:1(RX)

4.6 Polarity: 2-23, 5-20, 8-17, 11-14 In-Phase

4.7 Insertion Loss: -1.0 dB Max. @ 1-100MHz

4.8 Return Loss: -16 dB Min. @ 1-30MHz

-12 dB Min. @ 30-60 MHz

-10 dB Min. @ 60-80 MHz

4.9 Cross Talk: -42 dB Min. @ 1-60 MHz

-35 dB Min. @ 60-100 MHz

4.10 Common Mode Rejection : -40 dB Min. @ 1-30 MHz

-35 dB Min. @ 60 MHz

-30 dB Min. @ 80-100 MHz

4.11 Isolation HI-POT: 1500Vrms 1mA 1Second

DRAWN BY: CHECKED BY:		APPROVED BY:	CUSTOMER:
			PART NO. : G2436S
	深圳磁联达电子有限公司		REV.: A/0
	Shenzhen CND-TEK Electronics Co. Ltd.		PAGE: 3 OF 4

## 5. Recommended Lead Free IR Reflow Soldering Curve:

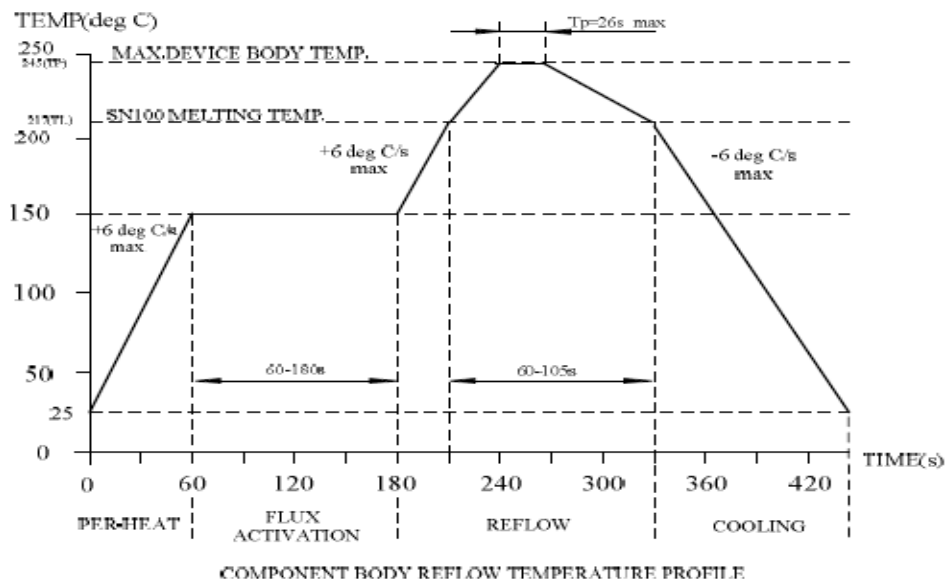

Item	Soldertechnique simulation	Temperature (°C)	Time(s)	Temperature ramp/immersion and emersion rate
1	Solder iron	350±10 (solder irno temp)	4~5	
2	Vapor phase reflow	215±5 (vapor temp)	60±5	
3	IR/convection reflow	255±5 (component temp)	30±5	1°C/s~4°C/s time above 183°C 90s~120s

Note: The curve includes recommended value only, please adjust your equipment to make sure the solder process. Details please refers to the standard J-STD-020.

## 6. Reliability Test Criteria:

6.1 Terminal strength: Pull test withstand 9.8N 60+/-0.5S no looseness or movement.

6.2 Solderbility: Dipped in 245°C+/-5°C molten solder for 3+/-0.5 seconds, 95% min shall be smooth any and bright.

6.3 Resistance to soldering heat : Convection reflow condition setting: peak temperature at 260°C+0/-5°C above 217°C for 90-180 seconds, ramp-up rate 2-3°C/s. Ramp-down rate 6°C/s Max. No mechanical problem found. No electrical failure found per our specification.

6.4 Vibration: 1.5mm amplitude total excursion 10-55-10 Hz traversed in 1minute, x,y,z, axis for 2 hours. Shall not be any abnormality.

6.5 Random drop (Packing condition): Height 60cm, 3 times on the wood floorboard ,shall not be any abnormality.

6.6 Dry heat: 100+/-2°C 96 hours.

6.7 Cold: -20+/-2°C 96 hours.

6.8 Damp Heat: 60+/-2°C, 93+/-3% RH 96 hours.

6.9 Change of temperature: exposed 5 cycle; each consisting of 30 minutes at -20+/-2°C, 2-3minutes at 20+/-2°C, 30 minutes at 85+/-2°C, 2-3 minutes at 20+/-2°C.

DRAWN BY: CHECKED BY:		APPROVED BY:	CUSTOMER:
			PART NO. : G2436S
	深圳磁联达电子有限公司		REV.: A/0
	Shenzhen CND-TEK Electronics Co. Ltd.		PAGE: 4 OF 4