

# Distributed I/O device - FLX ASI DIO 4/3 M12-2A



2773445

<https://www.phoenixcontact.com/us/products/2773445>

Please be informed that the data shown in this PDF document is generated from our Online Catalog. Please find the complete data in the user documentation. Our General Terms of Use for Downloads are valid.



AS-i digital I/O module, AB slave, 4 digital inputs, 24 V DC, 2, 3, and 4-conductor connection technology, 3 digital outputs, 24 V DC, IP67 protection

## Product Description

The digital Fieldline M12 AS-Interface input/output modules with IP67 housing protection make it possible to connect digital sensors and actuators to the AS-i using M12 plugs using the SPEEDCON connection method.

The modules are connected to AS-i using the flat-ribbon cable cable penetration technique.

## Your advantages

- Optimized for direct mounting and DIN rail mounting
- M12 connection technology with SPEEDCON fast locking system for the inputs and outputs
- Tool-free connection to AS-Interface using penetration technique

## Commercial Data

Item number	2773445
Packing unit	1 pc
Minimum order quantity	1 pc
Note	Made to Order (non-returnable)
Sales Key	C21
Product Key	DRI634
Catalog Page	Page 202 (C-6-2019)
GTIN	4046356156622
Weight per Piece (including packing)	302 g
Weight per Piece (excluding packing)	245 g
Customs tariff number	85176200
Country of origin	SG

# Distributed I/O device - FLX ASI DIO 4/3 M12-2A



2773445

<https://www.phoenixcontact.com/us/products/2773445>

## Technical Data

### Dimensions

Width	58 mm
Height	150 mm
Depth	35 mm
Drill hole spacing	108 mm

### Notes

#### Utilization restriction

EMC note	EMC: class A product, see manufacturer's declaration in the download area
----------	---

### Material specifications

Color	black
-------	-------

### Interfaces

#### AS-Interface

Connection method	Flat-ribbon cable penetration technique
Designation connection point	AS-i
Number of positions	4
Transmission speed	167 kbps

### System properties

#### Module

ID code (dec.)	10
ID code (hex)	A

### Input data

#### Digital

Input name	Digital inputs
Description of the input	IEC 61131-2 Type 2
Number of inputs	4
Connection method	M12 connector
Connection technology	2-, 3-conductor

### Output data

#### Digital

Output name	Digital outputs
Connection method	M12 connector
Connection technology	2-conductor
Number of outputs	3

# Distributed I/O device - FLX ASI DIO 4/3 M12-2A



2773445

<https://www.phoenixcontact.com/us/products/2773445>

Maximum output current per channel	2 A
Maximum output current per module / terminal block	4 A

## Product properties

Type	Block design
Product type	I/O component
Mounting position	any
No. of channels	7

## Electrical properties

No. of channels	7
-----------------	---

## Connection data

Connection method	M12 connector
-------------------	---------------

## Ambient conditions

Ambient temperature (operation)	-25 °C ... 70 °C
Degree of protection	IP65/IP67
Ambient temperature (storage/transport)	-25 °C ... 85 °C

## Standards and regulations

Protection class	III (IEC 61140, EN 61140, VDE 0140-1)
------------------	---------------------------------------

## Mounting

Mounting type	Screw on directly or on DIN rail
Mounting type	Wall mounting
Mounting position	any

# Distributed I/O device - FLX ASI DIO 4/3 M12-2A



2773445

<https://www.phoenixcontact.com/us/products/2773445>

## Drawings

Connection diagram

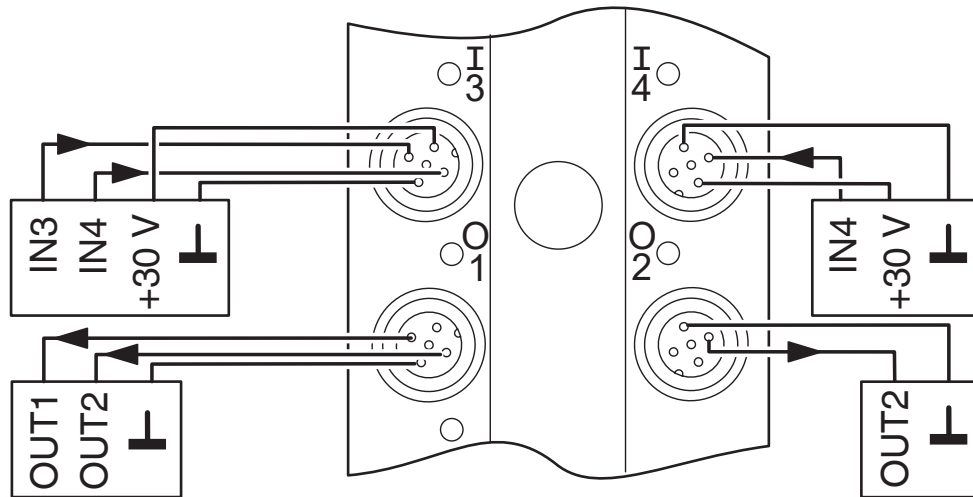

# Distributed I/O device - FLX ASI DIO 4/3 M12-2A



2773445

<https://www.phoenixcontact.com/us/products/2773445>

## Approvals

 **UL Listed**  
Approval ID: FILE E 238705

 **cUL Listed**  
Approval ID: FILE E 238705

 **ASI-Interface**  
Approval ID: 81301/ 06.11.07

**cULus Listed**

# Distributed I/O device - FLX ASI DIO 4/3 M12-2A



2773445

<https://www.phoenixcontact.com/us/products/2773445>

## Classifications

### ECLASS

ECLASS-9.0	27242604
ECLASS-10.0.1	27242604

### ETIM

ETIM 7.0	EC001599
----------	----------

### UNSPSC

UNSPSC 21.0	32151602
-------------	----------

# Distributed I/O device - FLX ASI DIO 4/3 M12-2A



2773445

<https://www.phoenixcontact.com/us/products/2773445>

## Environmental Product Compliance

REACH SVHC

Lead 7439-92-1

# Distributed I/O device - FLX ASI DIO 4/3 M12-2A



2773445

<https://www.phoenixcontact.com/us/products/2773445>

## Accessories

### Screw plug

Screw plug - PROT-M12 - 1680539

<https://www.phoenixcontact.com/us/products/1680539>



An M12 screw plug for the unoccupied M12 sockets of the sensor/actuator cable, boxes and flush-type connectors

---

### Manual addressing device

Manual addressing device - ASI CC ADR - 2741338

<https://www.phoenixcontact.com/us/products/2741338>



Manual addressing device, for AS-i modules



# Distributed I/O device - FLX ASI DIO 4/3 M12-2A



2773445

<https://www.phoenixcontact.com/us/products/2773445>

## Cable for programming

Cable for programming - ASI CC ADR CAB CINCH - 2741341

<https://www.phoenixcontact.com/us/products/2741341>



Cinch connecting cable, for addressing FLX ASI M12 devices

---

## Label sheet, DIN A4

Label sheet, DIN A4 - BMKL 11,5 (108X16) WH - 0821797

<https://www.phoenixcontact.com/us/products/0821797>

Label sheet, DIN A4, Sheet, white, unlabeled, can be labeled with: Office printing systems, mounting type: adhesive, lettering field size: 108 x 16 mm, Number of individual labels: 22



# Distributed I/O device - FLX ASI DIO 4/3 M12-2A



2773445

<https://www.phoenixcontact.com/us/products/2773445>

## Flat-ribbon conductor

Flat-ribbon conductor - VS-ASI-FC-EPDM-YE 100M - 1432402

<https://www.phoenixcontact.com/us/products/1432402>

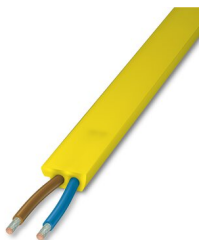

AS-Interface EPDM flat conductor in yellow, 2 x 1.5 mm<sup>2</sup>, 100 m ring

---

## Flat-ribbon conductor

Flat-ribbon conductor - VS-ASI-FC-EPDM-YE 1000M - 1434646

<https://www.phoenixcontact.com/us/products/1434646>

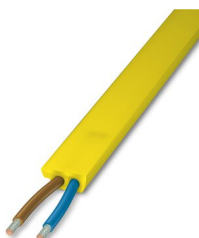

AS-Interface EPDM flat conductor in yellow, 2 x 1.5 mm<sup>2</sup>, 1000 m on a disposable drum

# Distributed I/O device - FLX ASI DIO 4/3 M12-2A



2773445

<https://www.phoenixcontact.com/us/products/2773445>

## Flat-ribbon conductor

Flat-ribbon conductor - VS-ASI-FC-TPE-UL-YE 100M - 1404922

<https://www.phoenixcontact.com/us/products/1404922>

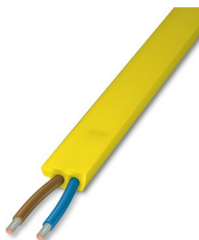

AS-Interface TPE flat conductor with UL in yellow, 2 x 1.5 mm<sup>2</sup>, 100 m ring

---

## Flat-ribbon conductor

Flat-ribbon conductor - VS-ASI-FC-TPE-UL-YE 1000M - 1434662

<https://www.phoenixcontact.com/us/products/1434662>

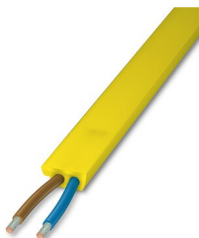

AS-Interface TPE flat conductor with UL in yellow, 2 x 1.5 mm<sup>2</sup>, 1000 m on disposable drum

# Distributed I/O device - FLX ASI DIO 4/3 M12-2A



2773445

<https://www.phoenixcontact.com/us/products/2773445>

## Flat-ribbon conductor

Flat-ribbon conductor - VS-ASI-FC-PVC-UL-YE 100M - 1404906

<https://www.phoenixcontact.com/us/products/1404906>

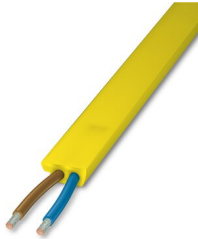

AS-Interface PVC flat conductor with UL in yellow, 2 x 1.5 mm<sup>2</sup>, 100 m ring

---

## Flat-ribbon conductor

Flat-ribbon conductor - VS-ASI-FC-PVC-UL-YE/1000 - 1404867

<https://www.phoenixcontact.com/us/products/1404867>

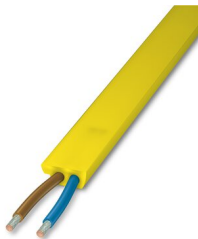

AS-Interface PVC flat conductor with UL in yellow, 2 x 1.5 mm<sup>2</sup>, 1000 m on an one-way drum

---

Phoenix Contact 2022 © - all rights reserved  
<https://www.phoenixcontact.com>

Phoenix Contact USA  
586 Fulling Mill Road  
Middletown, PA 17057, United States  
(+717) 944-1300  
[info@phoenixcon.com](mailto:info@phoenixcon.com)