

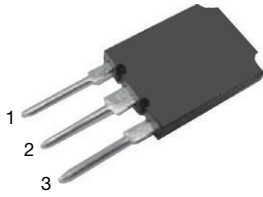

Thyristor High Voltage, Phase Control SCR, 70 A

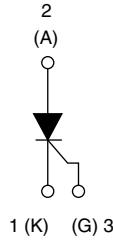

Super TO-247



FEATURES

- High surge capability
- High voltage input rectification
- Designed and qualified according to JEDEC®-JESD 47
- Material categorization: for definitions of compliance please see www.vishay.com/doc?99912



RoHS COMPLIANT

PRIMARY CHARACTERISTICS	
$I_{T(AV)}$	70 A
V_{DRM}/V_{RRM}	1200 V, 1600 V
V_{TM}	1.25 V
I_{GT}	100 mA
T_J	-40 °C to +125 °C
Package	Super TO-247
Circuit configuration	Single SCR

APPLICATIONS

- AC switches
- High voltage input rectification (soft start)
- High current crow-bar
- Other phase-control circuits
- Designed to be used with Vishay input diodes, switches, and output rectifiers which are available in identical package outlines

DESCRIPTION

The VS-70TPS.. PbF high voltage series of silicon controlled rectifiers are specifically designed for high and medium power switching, and phase control applications.

MAJOR RATINGS AND CHARACTERISTICS			
PARAMETER	TEST CONDITIONS	VALUES	UNITS
$I_{T(AV)}$	Sinusoidal waveform	70	A
I_{RMS}	Lead current limitation	75	
V_{RRM}/V_{DRM}	Range	1200 to 1600	V
I_{TSM}		1100	A
V_T	100 A, $T_J = 25\text{ °C}$	1.4	V
dV/dt		500	V/ μ s
dI/dt		150	A/ μ s
T_J		-40 to +125	°C

VOLTAGE RATINGS			
PART NUMBER	V_{RRM}/V_{DRM} , MAXIMUM REPETITIVE PEAK AND OFF-STATE VOLTAGE V	V_{RSM} , MAXIMUM NON-REPETITIVE PEAK REVERSE VOLTAGE V	I_{RRM}/I_{DRM} AT 125 °C mA
VS-70TPS12PbF	1200	1300	15
VS-70TPS16PbF	1600	1700	



VS-70TPS12PbF, VS-70TPS16PbF High Voltage Series

www.vishay.com

Vishay Semiconductors

ABSOLUTE MAXIMUM RATINGS					
PARAMETER	SYMBOL	TEST CONDITIONS		VALUES	UNITS
Maximum average on-state current	$I_{T(AV)}$	$T_C = 82\text{ }^\circ\text{C}$, 180° conduction half sine wave		70	A
Maximum continuous RMS on-state current as AC switch	$I_{T(RMS)}$	Lead current limitation		75	
Maximum peak, one-cycle non-repetitive surge current	I_{TSM}	10 ms sine pulse, rated V_{RRM} applied		930	A ² s
		10 ms sine pulse, no voltage reapplied		1100	
Maximum I^2t for fusing	I^2t	10 ms sine pulse, rated V_{RRM} applied		4325	
		10 ms sine pulse, no voltage reapplied		6115	
Maximum $I^2\sqrt{t}$ for fusing	$I^2\sqrt{t}$	$t = 0.1\text{ ms to }10\text{ ms}$, no voltage reapplied		61 150	A ² √s
Low level value of threshold voltage	$V_{T(TO)1}$	$T_J = 125\text{ }^\circ\text{C}$		0.916	V
High level value of threshold voltage	$V_{T(TO)2}$			1.21	
Low level value of on-state slope resistance	r_{t1}			4.138	mΩ
High level value of on-state slope resistance	r_{t2}			3.43	
Maximum peak on-state voltage	V_{TM}	100 A, $T_J = 25\text{ }^\circ\text{C}$		1.4	V
Maximum rate of rise of turned-on current	di/dt	$T_J = 25\text{ }^\circ\text{C}$		150	A/μs
Maximum holding current	I_H	Anode supply = 6 V, resistive load, initial $I_T = 1\text{ A}$, $T_J = 25\text{ }^\circ\text{C}$		200	mA
Maximum latching current	I_L	Anode supply = 6 V, resistive load, $T_J = 25\text{ }^\circ\text{C}$		400	
Maximum reverse and direct leakage current	I_{RRM}/I_{DRM}	$T_J = 25\text{ }^\circ\text{C}$		1.0	
		$T_J = 125\text{ }^\circ\text{C}$		15	
Maximum rate of rise of off-state voltage	dV/dt	$T_J = 125\text{ }^\circ\text{C}$		500	V/μs

TRIGGERING					
PARAMETER	SYMBOL	TEST CONDITIONS		VALUES	UNITS
Maximum peak gate power	P_{GM}	$T = 30\text{ }\mu\text{s}$		10	W
Maximum average gate power	$P_{G(AV)}$			2.5	
Maximum peak gate current	I_{GM}			2.5	A
Maximum peak negative gate voltage	$-V_{GM}$			10	V
Maximum required DC gate voltage to trigger	V_{GT}	$T_J = -40\text{ }^\circ\text{C}$		1.8	
		$T_J = 25\text{ }^\circ\text{C}$		1.5	
		$T_J = 125\text{ }^\circ\text{C}$		1.1	
Maximum required DC gate current to trigger	I_{GT}	$T_J = -40\text{ }^\circ\text{C}$		150	mA
		$T_J = 25\text{ }^\circ\text{C}$		100	
		$T_J = 125\text{ }^\circ\text{C}$		80	
Maximum DC gate voltage not to trigger	V_{GD}	$T_J = 125\text{ }^\circ\text{C}$, $V_{DRM} = \text{rated value}$		0.25	V
Maximum DC gate current not to trigger	I_{GD}			6	mA



THERMAL AND MECHANICAL SPECIFICATIONS				
PARAMETER	SYMBOL	TEST CONDITIONS	VALUES	UNITS
Maximum junction temperature range	T_J		-40 to +125	°C
Maximum storage temperature range	T_{Stg}		-40 to +150	
Maximum thermal resistance, junction to case	R_{thJC}	DC operation	0.27	°C/W
Maximum thermal resistance, junction to ambient	R_{thJA}		40	
Typical thermal resistance, case to heatsink	R_{thCS}	Mounting surface, smooth and greased	0.2	
Approximate weight			6	g
			0.21	oz.
Mounting torque	minimum		6 (5)	kgf · cm (lbf · in)
	maximum		12 (10)	
Marking device		Case style Super TO-247	70TPS12	
			70TPS16	

ΔR_{thJ-hs} CONDUCTION PER JUNCTION											
DEVICE	SINE HALF WAVE CONDUCTION					RECTANGULAR WAVE CONDUCTION					UNITS
	180°	120°	90°	60°	30°	180°	120°	90°	60°	30°	
VS-70TPS..PbF	0.078	0.092	0.117	0.172	0.302	0.053	0.092	0.125	0.180	0.306	°C/W

Note

- The table above shows the increment of thermal resistance R_{thJ-hs} when devices operate at different conduction angles than DC

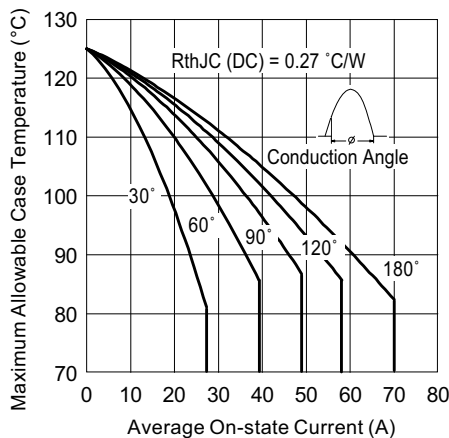

Fig. 1 - Current Rating Characteristics

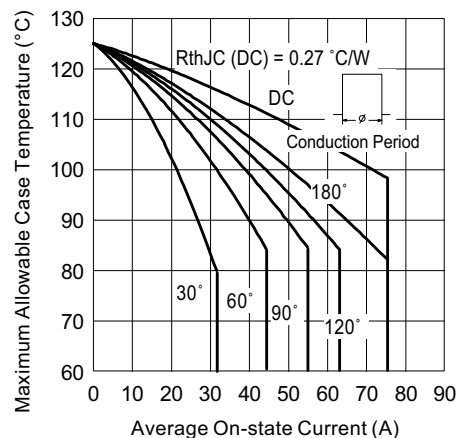

Fig. 2 - Current Rating Characteristics

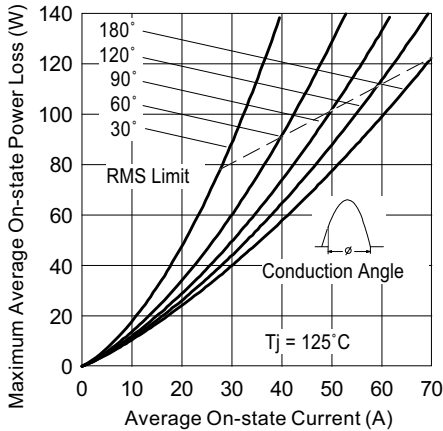

Fig. 3 - On-State Power Loss Characteristics

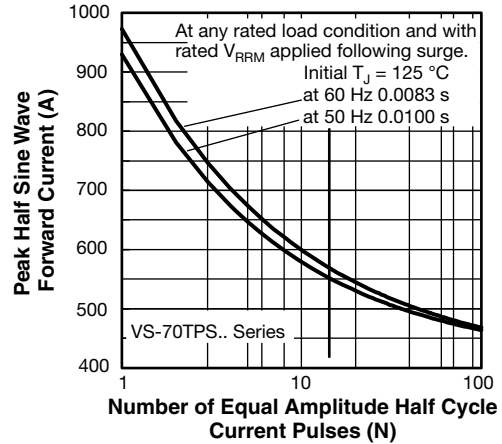

Fig. 5 - Maximum Non-Repetitive Surge Current

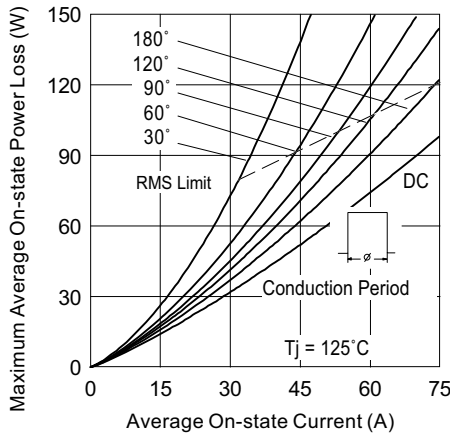

Fig. 4 - On-State Power Loss Characteristics

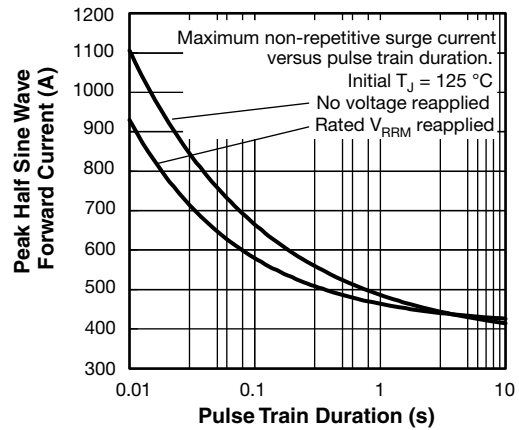

Fig. 6 - Maximum Non-Repetitive Surge Current

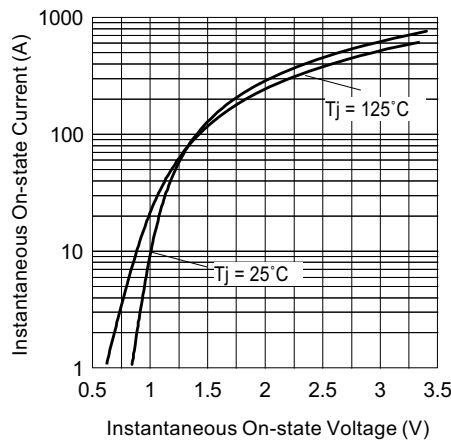

Fig. 7 - On-State Voltage Drop Characteristics

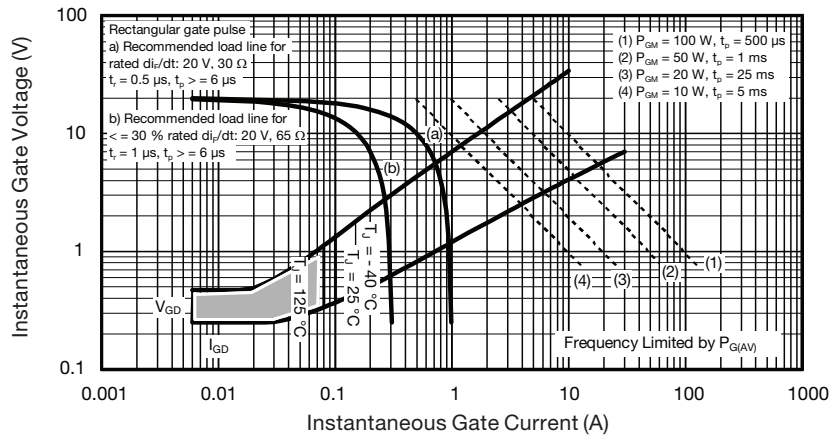

Fig. 8 - Gate Characteristics

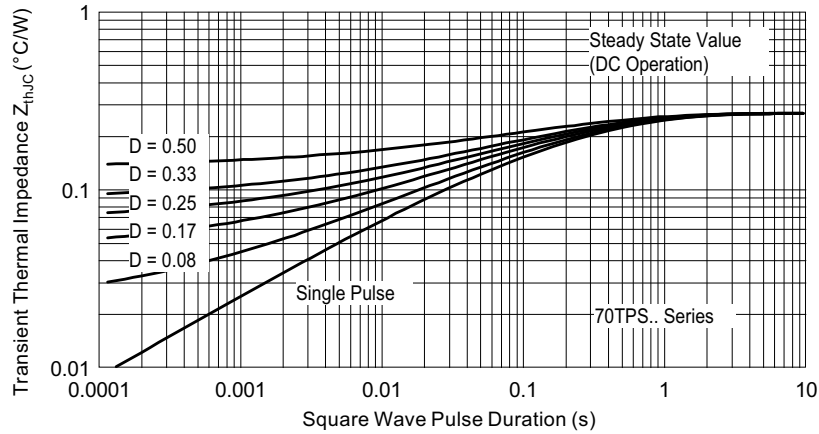
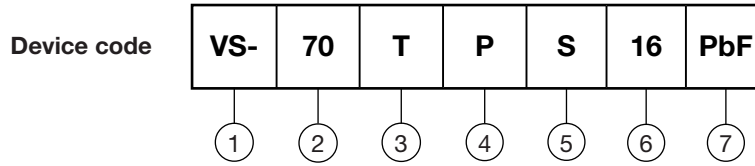

Fig. 9 - Thermal Impedance Z_{thJC} Characteristics



ORDERING INFORMATION TABLE



- 1** - Vishay Semiconductors product
- 2** - Current rating (70 = 70 A)
- 3** - Circuit configuration:
T = thyristor
- 4** - Package:
P = super TO-247
- 5** - Type of silicon:
S = standard recovery rectifier
- 6** - Voltage code x 100 = V_{RRM}

12 = 1200 V
16 = 1600 V
- 7** - PbF = lead (Pb)-free

ORDERING INFORMATION (example)			
PREFERRED P/N	QUANTITY PER T/R	MINIMUM ORDER QUANTITY	PACKAGING DESCRIPTION
VS-70TPS12PbF	25	500	Antistatic plastic tube
VS-70TPS16PbF	25	500	Antistatic plastic tube

LINKS TO RELATED DOCUMENTS	
Dimensions	www.vishay.com/doc?95073
Part marking information	www.vishay.com/doc?95070
SPICE model VS-70TPS12	www.vishay.com/doc?96760
SPICE model VS-70TPS16	www.vishay.com/doc?96761

Super TO-247

DIMENSIONS in millimeters (inches)

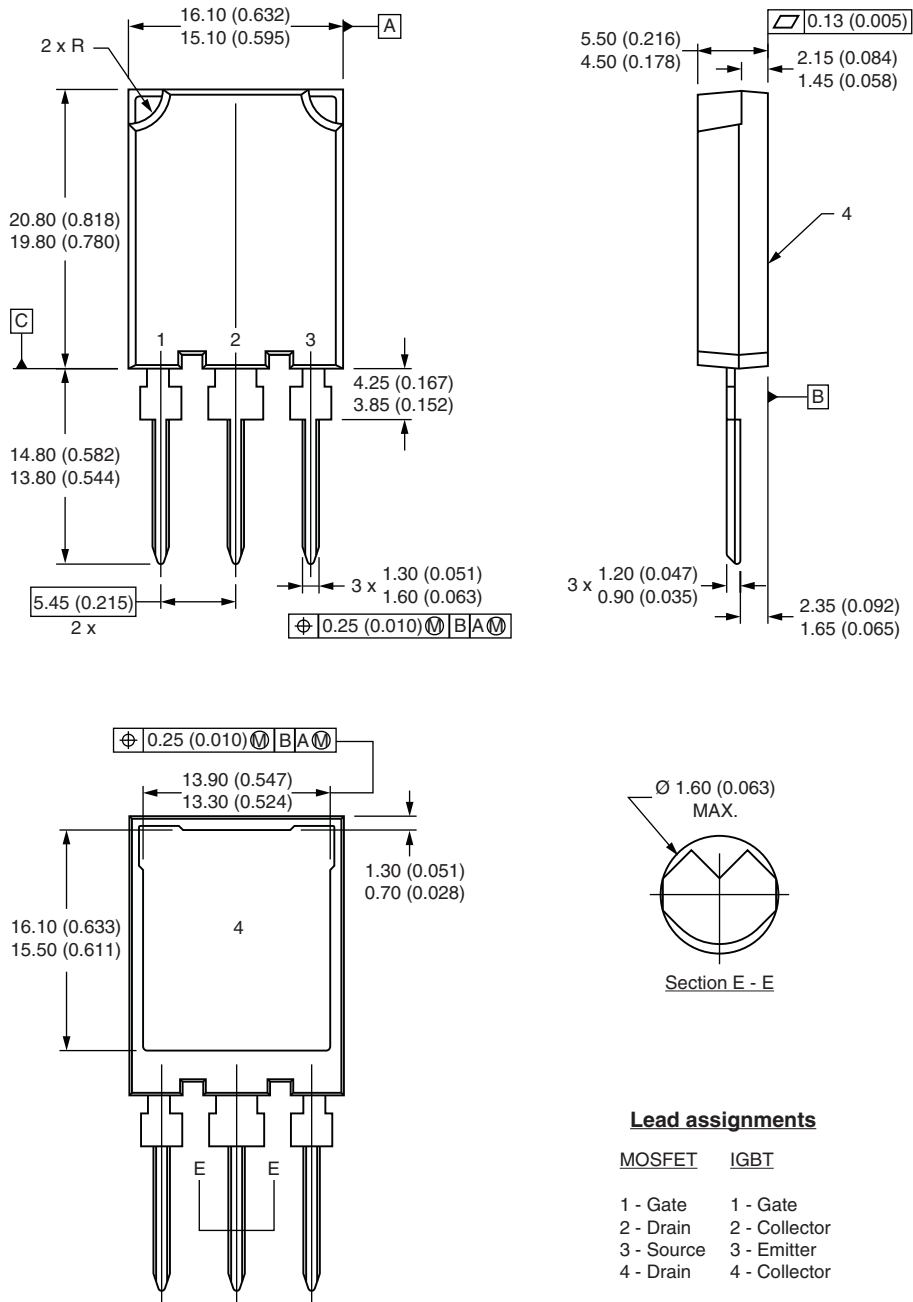

Lead assignments

MOSFET	IGBT
1 - Gate	1 - Gate
2 - Drain	2 - Collector
3 - Source	3 - Emitter
4 - Drain	4 - Collector

Notes

- (1) Dimension and tolerancing per ASME Y14.5M-1994
- (2) Controlling dimension: millimeter
- (3) Outline conforms to JEDEC® outline TO-274AA



Disclaimer

ALL PRODUCT, PRODUCT SPECIFICATIONS AND DATA ARE SUBJECT TO CHANGE WITHOUT NOTICE TO IMPROVE RELIABILITY, FUNCTION OR DESIGN OR OTHERWISE.

Vishay Intertechnology, Inc., its affiliates, agents, and employees, and all persons acting on its or their behalf (collectively, "Vishay"), disclaim any and all liability for any errors, inaccuracies or incompleteness contained in any datasheet or in any other disclosure relating to any product.

Vishay makes no warranty, representation or guarantee regarding the suitability of the products for any particular purpose or the continuing production of any product. To the maximum extent permitted by applicable law, Vishay disclaims (i) any and all liability arising out of the application or use of any product, (ii) any and all liability, including without limitation special, consequential or incidental damages, and (iii) any and all implied warranties, including warranties of fitness for particular purpose, non-infringement and merchantability.

Statements regarding the suitability of products for certain types of applications are based on Vishay's knowledge of typical requirements that are often placed on Vishay products in generic applications. Such statements are not binding statements about the suitability of products for a particular application. It is the customer's responsibility to validate that a particular product with the properties described in the product specification is suitable for use in a particular application. Parameters provided in datasheets and / or specifications may vary in different applications and performance may vary over time. All operating parameters, including typical parameters, must be validated for each customer application by the customer's technical experts. Product specifications do not expand or otherwise modify Vishay's terms and conditions of purchase, including but not limited to the warranty expressed therein.

Hyperlinks included in this datasheet may direct users to third-party websites. These links are provided as a convenience and for informational purposes only. Inclusion of these hyperlinks does not constitute an endorsement or an approval by Vishay of any of the products, services or opinions of the corporation, organization or individual associated with the third-party website. Vishay disclaims any and all liability and bears no responsibility for the accuracy, legality or content of the third-party website or for that of subsequent links.

Except as expressly indicated in writing, Vishay products are not designed for use in medical, life-saving, or life-sustaining applications or for any other application in which the failure of the Vishay product could result in personal injury or death. Customers using or selling Vishay products not expressly indicated for use in such applications do so at their own risk. Please contact authorized Vishay personnel to obtain written terms and conditions regarding products designed for such applications.

No license, express or implied, by estoppel or otherwise, to any intellectual property rights is granted by this document or by any conduct of Vishay. Product names and markings noted herein may be trademarks of their respective owners.