

ULTRALOW QUIESCENT CURRENT 250-mA LOW DROPOUT VOLTAGE REGULATORS

FEATURES

- 250-mA Low Dropout Voltage Regulator
- Available in 1.5 V, 1.8 V, 2.5 V, 2.7 V, 2.8 V, 3.0 V, 3.3 V, 5.0 V Fixed Output and Adjustable Versions
- Dropout Voltage to 140 mV (Typ) at 250 mA (TPS76650)
- Ultralow 35- μ A Typical Quiescent Current
- 3% Tolerance Over Specified Conditions for Fixed Output Versions
- Open-Drain Power Good
- 8-Pin SOIC Package
- Thermal Shutdown Protection

DESCRIPTION

This device is designed to have an ultralow quiescent current and be stable with a 4.7- μ F capacitor. This combination provides high performance at a reasonable cost.

Because the PMOS device behaves as a low-value resistor, the dropout voltage is very low (typically 230 mV at an output current of 250 mA for the TPS76650) and is directly proportional to the output current. Additionally, since the PMOS pass element is a voltage-driven device, the quiescent current is very low and independent of output loading (typically 35 μ A over the full range of output current, 0 mA to 250 mA). These two key specifications yield a significant improvement in operating life for battery-powered systems. This LDO family also features a sleep mode; applying a TTL high signal to $\overline{\text{EN}}$ (enable) shuts down the regulator, reducing the quiescent current to less than 1 μ A (typ).

Power good (PG) is an active high output that can be used to implement a power-on reset or a low-battery indicator.

The TPS766xx is offered in 1.5 V, 1.8 V, 2.5 V, 2.7 V, 2.8 V, 3.0 V, 3.3 V and 5.0 V fixed voltage versions and in an adjustable version (programmable over the range of 1.25 V to 5.5 V). Output voltage tolerance is specified as a maximum of 3% over line, load, and temperature ranges. The TPS766xx family is available in an 8-pin SOIC package.

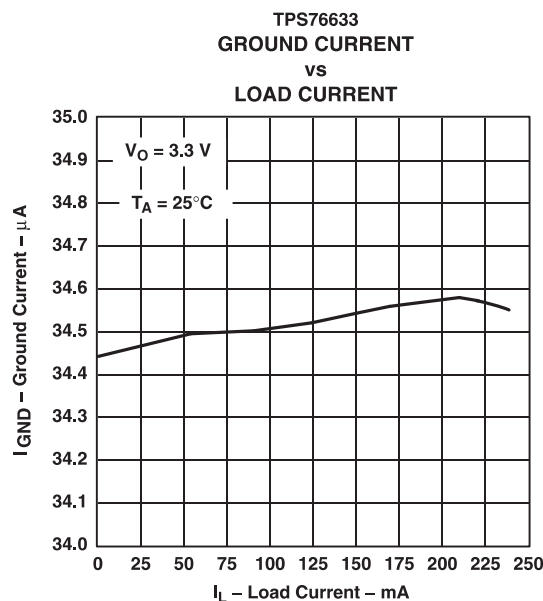
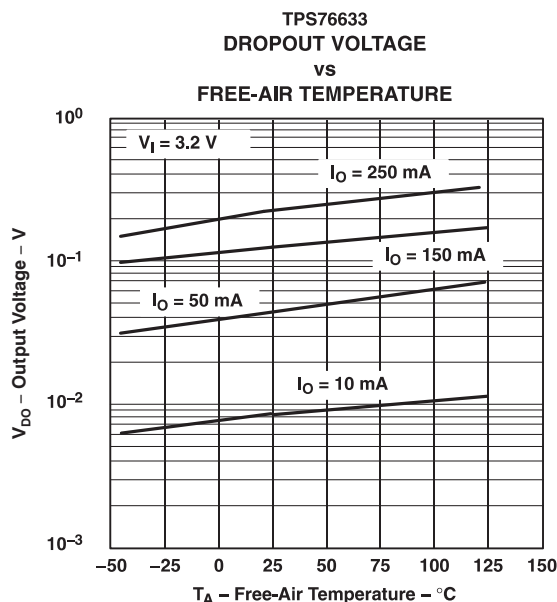

Please be aware that an important notice concerning availability, standard warranty, and use in critical applications of Texas Instruments semiconductor products and disclaimers thereto appears at the end of this data sheet.

All trademarks are the property of their respective owners.



This integrated circuit can be damaged by ESD. Texas Instruments recommends that all integrated circuits be handled with appropriate precautions. Failure to observe proper handling and installation procedures can cause damage.

ESD damage can range from subtle performance degradation to complete device failure. Precision integrated circuits may be more susceptible to damage because very small parametric changes could cause the device not to meet its published specifications.

ORDERING INFORMATION⁽¹⁾

PRODUCT	V _{OUT} ⁽²⁾
TPS766xyz	XX is nominal output voltage (for example, 28 = 2.8V, 01 = Adjustable). ⁽³⁾ Y is package designator. Z is package quantity.

- (1) For the most current package and ordering information see the Package Option Addendum at the end of this document, or see the TI website at www.ti.com.
- (2) Output voltages from 1.5 V to 5.0 V in 50-mV increments are available through the use of innovative factory EEPROM programming; minimum order quantities may apply. Contact factory for details and availability.
- (3) The TPS76601 is programmable using an external resistor divider (see [Application Information](#)).

ABSOLUTE MAXIMUM RATINGS

Over operating free-air temperature range (unless otherwise noted).⁽¹⁾

PARAMETER		TPS766xx	UNIT
V _I	Input voltage range ⁽²⁾	–0.3 to 13.5	V
	Voltage range at \overline{EN}	–0.3 to 16.5	V
	Maximum PG voltage	16.5	V
	Peak output current	Internally limited	
	Continuous total power dissipation	See Dissipation Ratings Table	
V _O	Output voltage (OUT, FB)	7	V
T _J	Operating virtual junction temperature range	–40 to +125	°C
T _{stg}	Storage temperature range	–65 to +150	°C
	ESD rating, HBM	2	kV

- (1) Stresses above these ratings may cause permanent damage. Exposure to absolute maximum conditions for extended periods may degrade device reliability. These are stress ratings only, and functional operation of the device at these or any other conditions beyond those specified is not implied.
- (2) All voltage values are with respect to network terminal ground.

DISSIPATION RATINGS

PACKAGE	AIR FLOW (CFM)	T _A < +25°C POWER RATING	DERATING FACTOR ABOVE T _A = +25°C	T _A = +70°C POWER RATING	T _A = +85°C POWER RATING
D	0	568 mW	5.68 mW/°C	312 mW	227 mW
	250	904 mW	9.04 mW/°C	497 mW	361 mW

RECOMMENDED OPERATING CONDITIONS

		MIN	MAX	UNIT
V _I	Input voltage ⁽¹⁾	2.7	10	V
V _O	Output voltage range	1.2	5.5	V
I _O	Output current ⁽²⁾	0	250	mA
T _J	Operating virtual junction temperature ⁽²⁾	–40	125	°C

- (1) To calculate the minimum input voltage for your maximum output current, use the following equation: $V_{I(\min)} = V_{O(\max)} + V_{DO(\max \text{ load})}$
- (2) Continuous current and operating junction temperature are limited by internal protection circuitry, but it is not recommended that the device operate under conditions beyond those specified in this table for extended periods of time.

ELECTRICAL CHARACTERISTICS

Over recommended operating free-air temperature range, $V_I = V_{O(\text{typ})} + 1 \text{ V}$, $I_O = 10 \mu\text{A}$, $\overline{\text{EN}} = 0 \text{ V}$, $C_O = 4.7 \mu\text{F}$ (unless otherwise noted).

PARAMETER		TEST CONDITIONS	MIN	TYP	MAX	UNIT
Output voltage (10 μA to 250 mA load) ⁽¹⁾	TPS76601	$5.5 \text{ V} \geq V_O \geq 1.25 \text{ V}$, $T_J = +25^\circ\text{C}$		V_O		
		$5.5 \text{ V} \geq V_O \geq 1.25 \text{ V}$, $T_J = -40^\circ\text{C}$ to $+125^\circ\text{C}$	0.97 V_O		1.03 V_O	
	TPS76615	$T_J = +25^\circ\text{C}$, $2.7 \text{ V} < V_{\text{IN}} < 10 \text{ V}$		1.5		
		$T_J = -40^\circ\text{C}$ to $+125^\circ\text{C}$, $2.7 \text{ V} < V_{\text{IN}} < 10 \text{ V}$	1.455		1.545	
	TPS76618	$T_J = +25^\circ\text{C}$, $2.8 \text{ V} < V_{\text{IN}} < 10 \text{ V}$		1.8		
		$T_J = -40^\circ\text{C}$ to $+125^\circ\text{C}$, $2.8 \text{ V} < V_{\text{IN}} < 10 \text{ V}$	1.746		1.854	
	TPS76625	$T_J = +25^\circ\text{C}$, $3.5 \text{ V} < V_{\text{IN}} < 10 \text{ V}$		2.5		
		$T_J = -40^\circ\text{C}$ to $+125^\circ\text{C}$, $3.5 \text{ V} < V_{\text{IN}} < 10 \text{ V}$	2.425		2.575	
	TPS76627	$T_J = +25^\circ\text{C}$, $3.7 \text{ V} < V_{\text{IN}} < 10 \text{ V}$		2.7		
		$T_J = -40^\circ\text{C}$ to $+125^\circ\text{C}$, $3.7 \text{ V} < V_{\text{IN}} < 10 \text{ V}$	2.619		2.781	
	TPS76628	$T_J = +25^\circ\text{C}$, $3.8 \text{ V} < V_{\text{IN}} < 10 \text{ V}$		2.8		
		$T_J = -40^\circ\text{C}$ to $+125^\circ\text{C}$, $3.8 \text{ V} < V_{\text{IN}} < 10 \text{ V}$	2.716		2.884	
	TPS76630	$T_J = +25^\circ\text{C}$, $4.0 \text{ V} < V_{\text{IN}} < 10 \text{ V}$		3.0		
		$T_J = -40^\circ\text{C}$ to $+125^\circ\text{C}$, $4.0 \text{ V} < V_{\text{IN}} < 10 \text{ V}$	2.910		3.090	
	TPS76633	$T_J = +25^\circ\text{C}$, $4.3 \text{ V} < V_{\text{IN}} < 10 \text{ V}$		3.3		
		$T_J = -40^\circ\text{C}$ to $+125^\circ\text{C}$, $4.3 \text{ V} < V_{\text{IN}} < 10 \text{ V}$	3.201		3.399	
TPS76650	$T_J = +25^\circ\text{C}$, $6.0 \text{ V} < V_{\text{IN}} < 10 \text{ V}$		5.0			
	$T_J = -40^\circ\text{C}$ to $+125^\circ\text{C}$, $6.0 \text{ V} < V_{\text{IN}} < 10 \text{ V}$	4.850		5.150		
Quiescent current (GND current) $\overline{\text{EN}} = 0 \text{ V}^{(1)}$	$10 \mu\text{A} < I_O < 250 \text{ mA}$, $T_J = +25^\circ\text{C}$		35			μA
	$I_O = 250 \text{ mA}$, $T_J = -40^\circ\text{C}$ to $+125^\circ\text{C}$			50		
Output voltage line regulation ($\Delta V_O/V_O$) ^{(1),(2)}	$V_O + 1 \text{ V} < V_I \leq 10 \text{ V}$, $T_J = +25^\circ\text{C}$		0.01			%/V
Load regulation	$I_O = 10 \mu\text{A}$ to 250 mA		0.5%			
Output noise voltage	BW = 300 Hz to 50 kHz, $C_O = 4.7 \mu\text{F}$, $T_J = +25^\circ\text{C}$		200			μV_{rms}
Output current limit	$V_O = 0 \text{ V}$		0.8	1.2		A
Thermal shutdown junction temperature			150			$^\circ\text{C}$
Standby current	$\overline{\text{EN}} = V_I$, $T_J = +25^\circ\text{C}$, $2.7 \text{ V} < V_I < 10 \text{ V}$		1			μA
	$\overline{\text{EN}} = V_I$, $T_J = -40^\circ\text{C}$ to $+125^\circ\text{C}$, $2.7 \text{ V} < V_I < 10 \text{ V}$			10		μA
FB input current	TPS76601 $\text{FB} = 1.5 \text{ V}$		2			nA
High level enable input voltage			2.0			V
Low level enable input voltage				0.8		V
Power-supply ripple rejection ⁽¹⁾	$f = 1 \text{ kHz}$, $I_O = 10 \mu\text{A}$, $C_O = 4.7 \mu\text{F}$, $T_J = +25^\circ\text{C}$		63			dB

(1) Minimum IN operating voltage is 2.7 V or $V_{O(\text{typ})} + 1 \text{ V}$, whichever is greater. Maximum IN voltage 10 V.

(2) If $V_O \geq 1.8 \text{ V}$ then $V_{\text{imin}} = 2.7 \text{ V}$, $V_{\text{imax}} = 10 \text{ V}$:

$$\text{Line Reg. (mV)} = (\%/V) \times \frac{V_O(V_{\text{imax}} - 2.7 \text{ V})}{100} \times 1000$$

If $V_O \leq 2.5 \text{ V}$ then $V_{\text{imin}} = V_O + 1 \text{ V}$, $V_{\text{imax}} = 10 \text{ V}$:

$$\text{Line Reg. (mV)} = (\%/V) \times \frac{V_O(V_{\text{imax}} - (V_O + 1 \text{ V}))}{100} \times 1000$$

ELECTRICAL CHARACTERISTICS (continued)

Over recommended operating free-air temperature range, $V_I = V_{O(\text{typ})} + 1 \text{ V}$, $I_O = 10 \mu\text{A}$, $\overline{\text{EN}} = 0 \text{ V}$, $C_O = 4.7 \mu\text{F}$ (unless otherwise noted).

PARAMETER		TEST CONDITIONS		MIN	TYP	MAX	UNIT	
PG	Minimum input voltage for valid PG	$I_{O(\text{PG})} = 300 \mu\text{A}$		1.1				
	Trip threshold voltage	V_O decreasing		92	98		$\%V_O$	
	Hysteresis voltage	Measured at V_O		0.5			$\%V_O$	
	Output low voltage	$V_I = 2.7 \text{ V}$,	$I_{O(\text{PG})} = 1 \text{ mA}$		0.15	0.4		V
	Leakage current	$V_{(\text{PG})} = 5 \text{ V}$		1			μA	
Input current ($\overline{\text{EN}}$)		$\overline{\text{EN}} = 0 \text{ V}$		-1	0	1	μA	
		$\overline{\text{EN}} = V_I$		-1	1			
Dropout voltage ⁽³⁾	TPS76628	$I_O = 250 \text{ mA}$,	$T_J = +25^\circ\text{C}$	310			mV	
		$I_O = 250 \text{ mA}$,	$T_J = -40^\circ\text{C to } +125^\circ\text{C}$	540				
	TPS76630	$I_O = 250 \text{ mA}$,	$T_J = +25^\circ\text{C}$	270				
		$I_O = 250 \text{ mA}$,	$T_J = -40^\circ\text{C to } +125^\circ\text{C}$	470				
	TPS76633	$I_O = 250 \text{ mA}$,	$T_J = +25^\circ\text{C}$	230				
		$I_O = 250 \text{ mA}$,	$T_J = -40^\circ\text{C to } +125^\circ\text{C}$	400				
	TPS76650	$I_O = 250 \text{ mA}$,	$T_J = +25^\circ\text{C}$	140				
		$I_O = 250 \text{ mA}$,	$T_J = -40^\circ\text{C to } +125^\circ\text{C}$	250				

(3) IN voltage equals $V_{O(\text{Typ})} - 100 \text{ mV}$; TPS76601 output voltage set to 3.3 V nominal with external resistor divider. TPS76615, TPS76618, TPS76625, and TPS76627 dropout voltage limited by input voltage range limitations (that is, TPS76630 input voltage must drop to 2.9 V for purpose of this test).

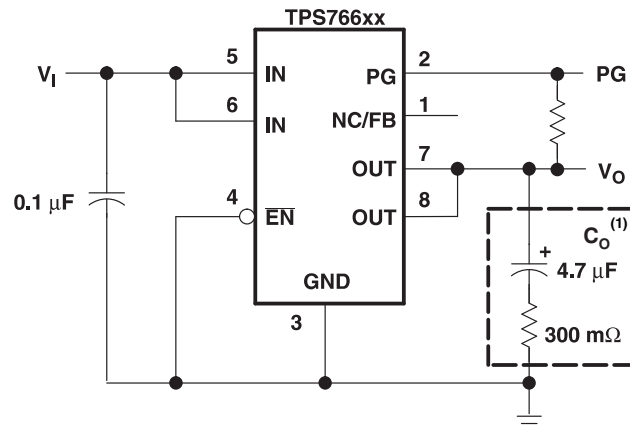

(1) See [Applications Information](#) section for capacitor selection details.

Figure 1. Typical Application Configuration for Fixed Output Options

FUNCTIONAL BLOCK DIAGRAM—ADJUSTABLE VERSION

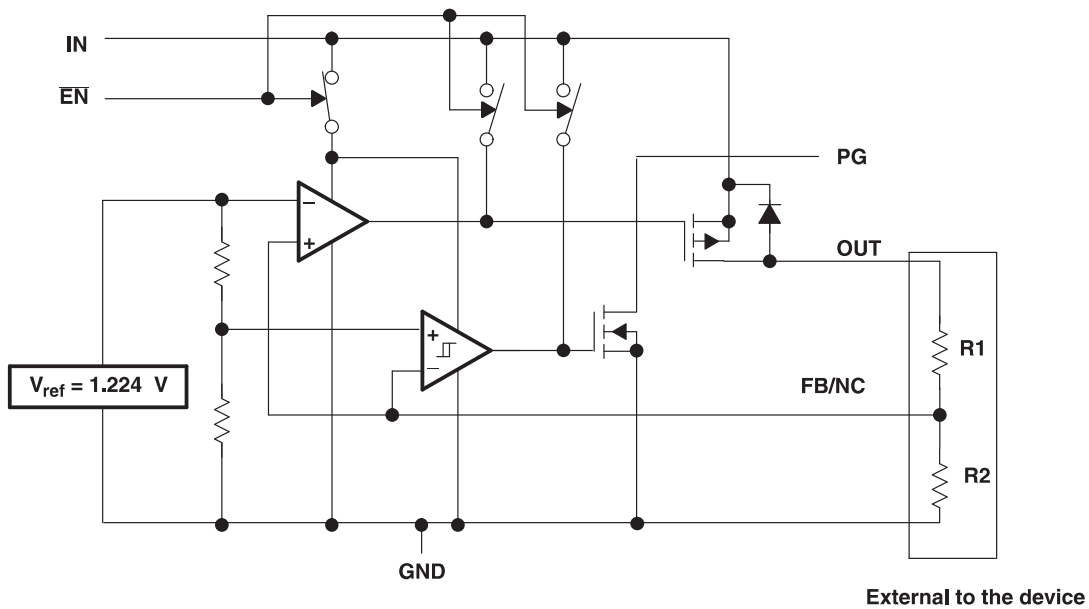

FUNCTIONAL BLOCK DIAGRAM—FIXED-VOLTAGE VERSION

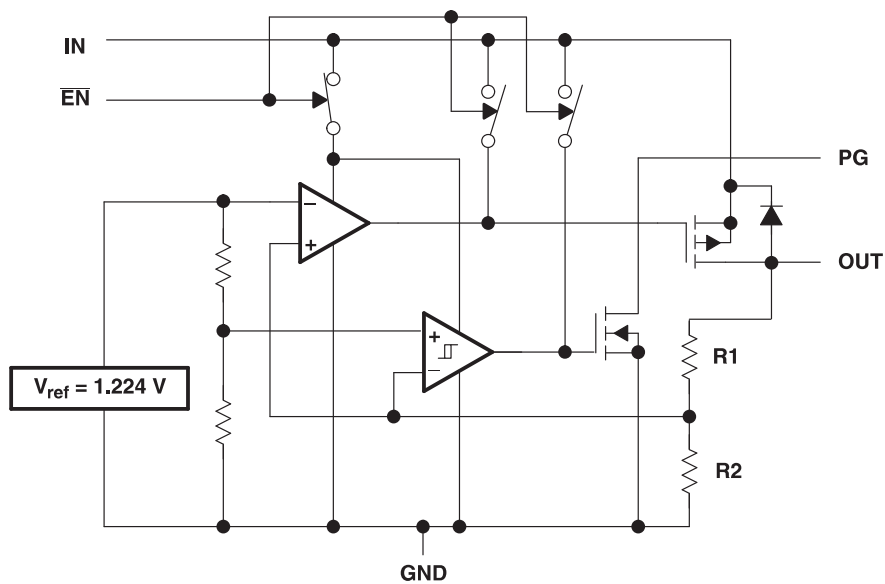

**D PACKAGE
 SOIC-8
 (TOP VIEW)**

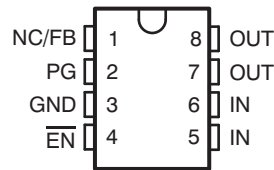

PIN DESCRIPTIONS

TPS766xx		I/O	DESCRIPTION
NAME	NO.		
$\overline{\text{EN}}$	4	I	Enable input.
FB/NC	1	I	Feedback input voltage for adjustable device (not connected for fixed options).
GND	3		Regulator ground.
IN	5, 6	I	Input voltage.
OUT	7, 8	O	Regulated output voltage.
PG	2	O	Power good output.

Table 1. Table of Graphs

		FIGURE
Output voltage	vs Load current	Figure 2, Figure 3
	vs Free-air temperature	Figure 4, Figure 5
Ground current	vs Load current	Figure 6, Figure 7
	vs Free-air temperature	Figure 8, Figure 9
Power-supply ripple rejection	vs Frequency	Figure 10
Output spectral noise density	vs Frequency	Figure 11
Output impedance	vs Frequency	Figure 12
Dropout voltage	vs Free-air temperature	Figure 13, Figure 14
Line transient response		Figure 15, Figure 17
Load transient response		Figure 16, Figure 18
Output voltage	vs Time	Figure 19
Dropout voltage	vs Input voltage	Figure 20
Equivalent series resistance (ESR)	vs Output current	Figure 21 to Figure 24
Equivalent series resistance (ESR)	vs Added ceramic capacitance	Figure 25, Figure 26

TYPICAL CHARACTERISTICS

TPS76633
 OUTPUT VOLTAGE
 vs
 LOAD CURRENT

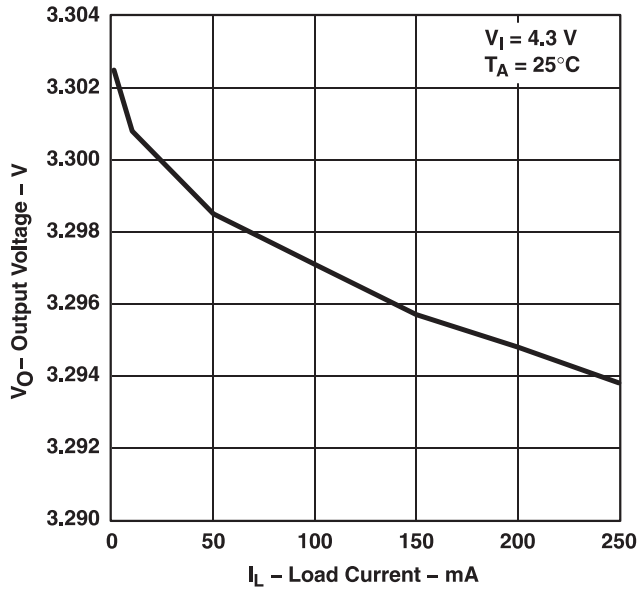

Figure 2.

TPS76615
 OUTPUT VOLTAGE
 vs
 LOAD CURRENT

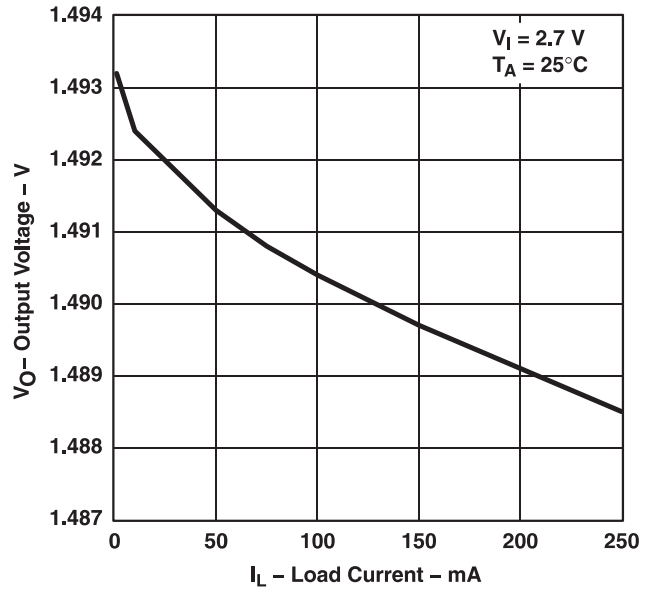

Figure 3.

TPS76633
 OUTPUT VOLTAGE
 vs
 FREE-AIR TEMPERATURE

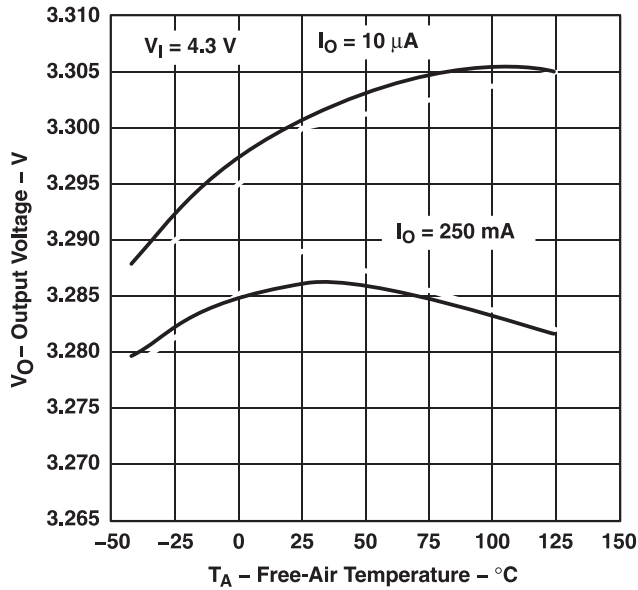

Figure 4.

TPS76615
 OUTPUT VOLTAGE
 vs
 FREE-AIR TEMPERATURE

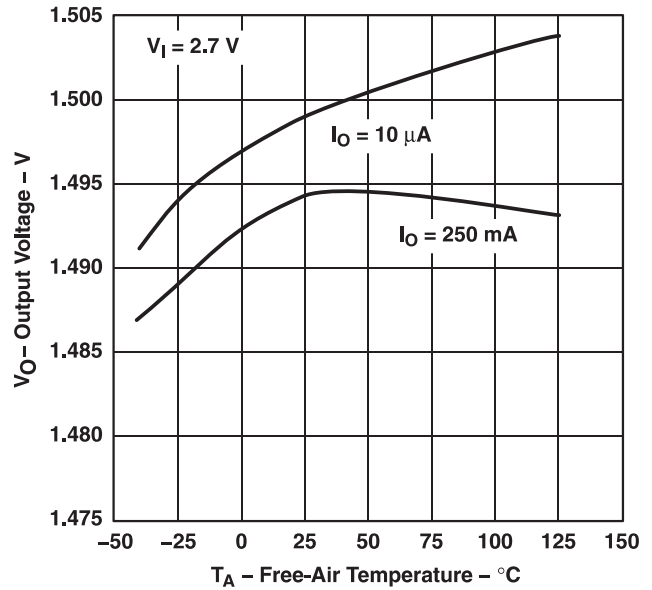

Figure 5.

TYPICAL CHARACTERISTICS (continued)

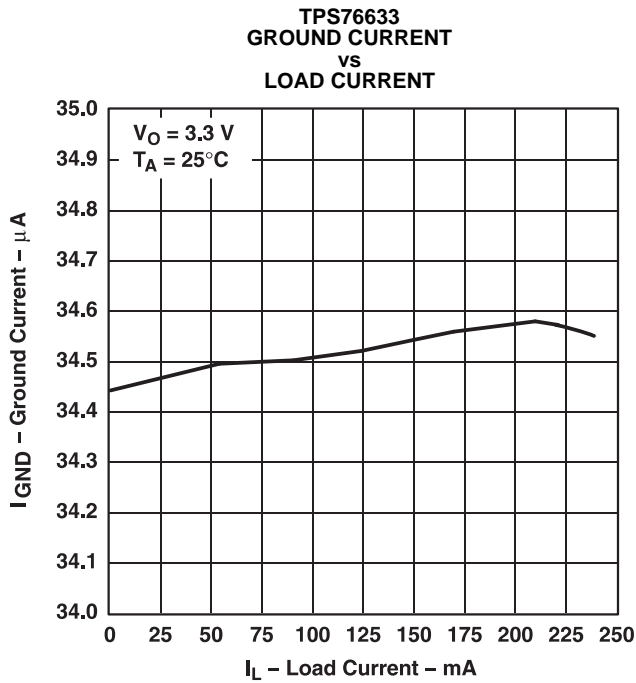

Figure 6.

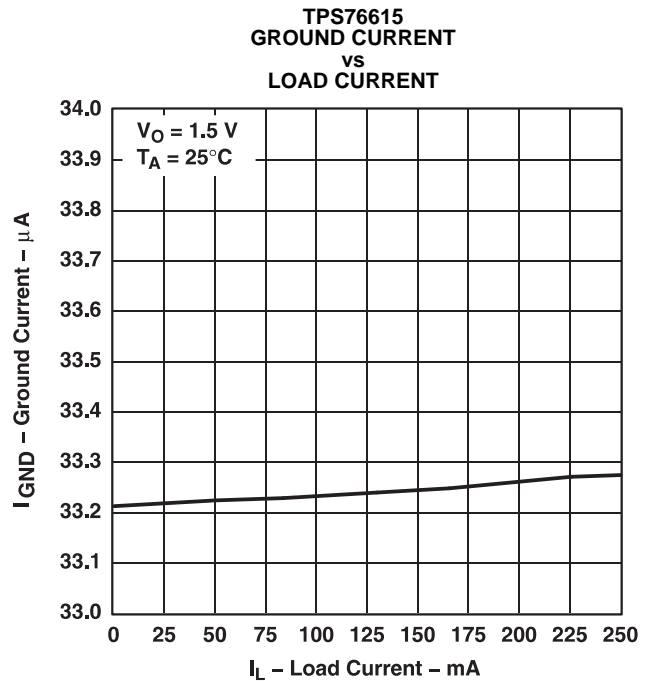

Figure 7.

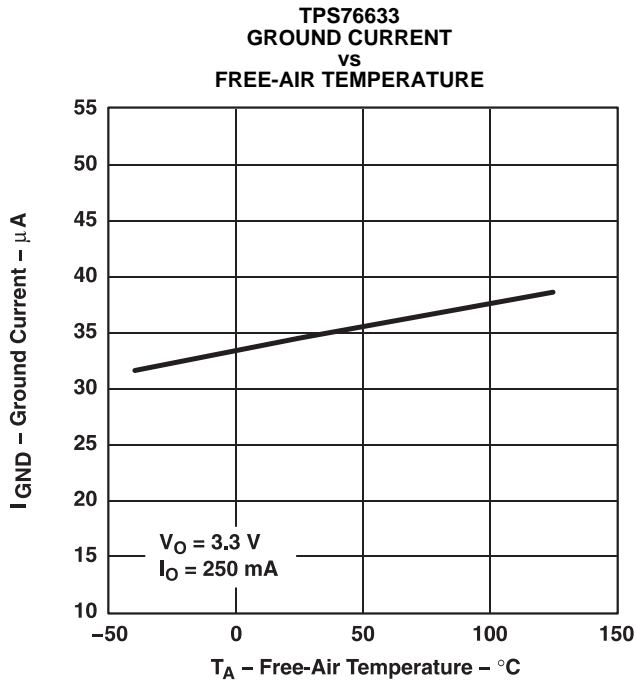

Figure 8.

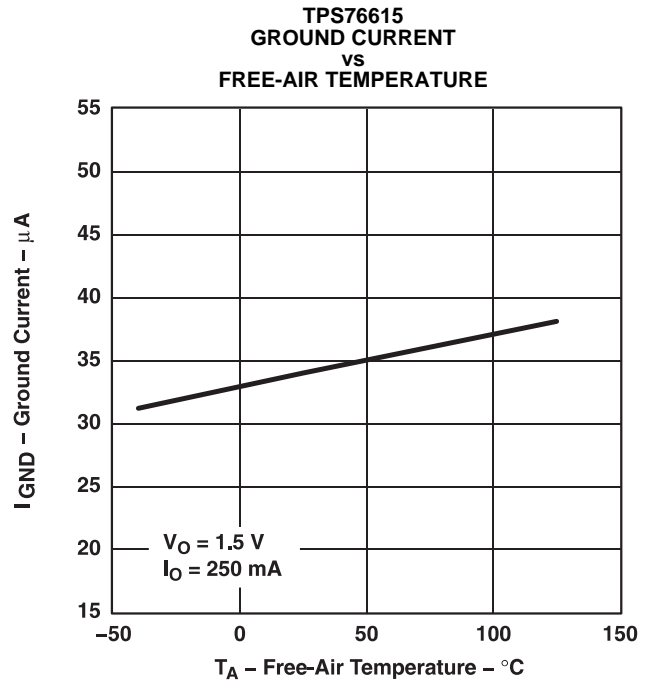
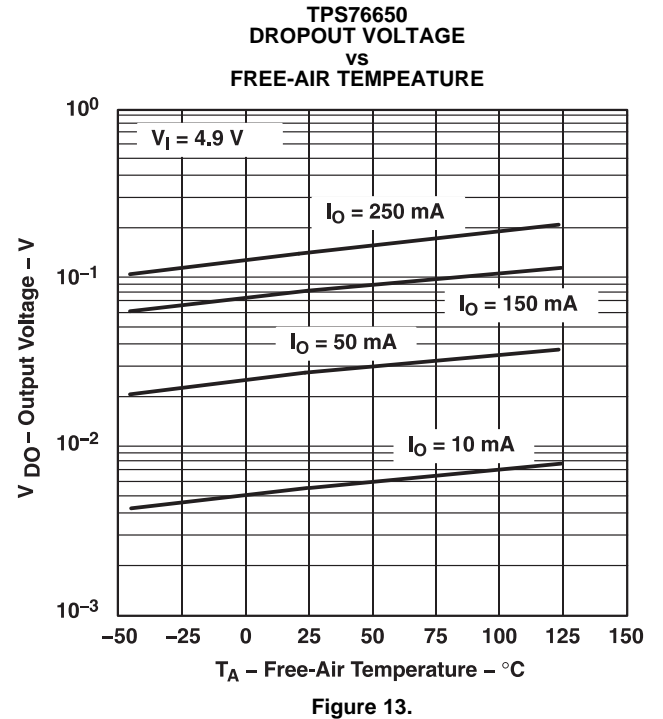
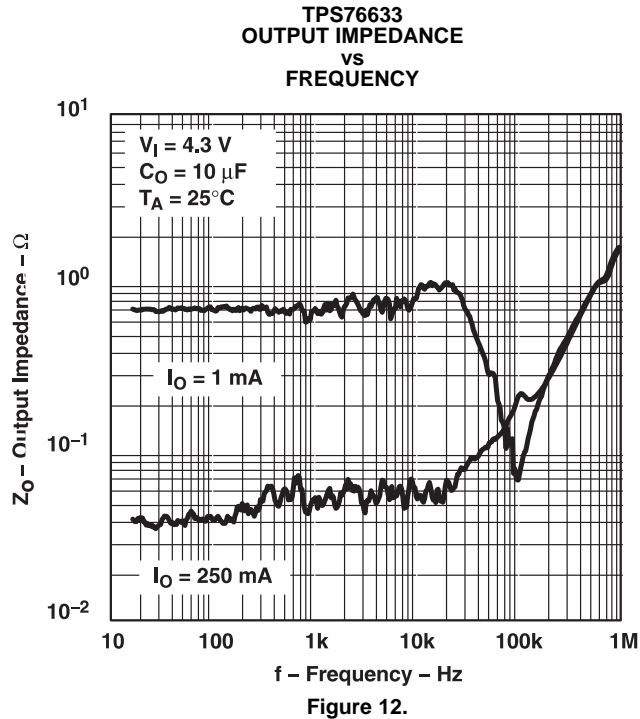
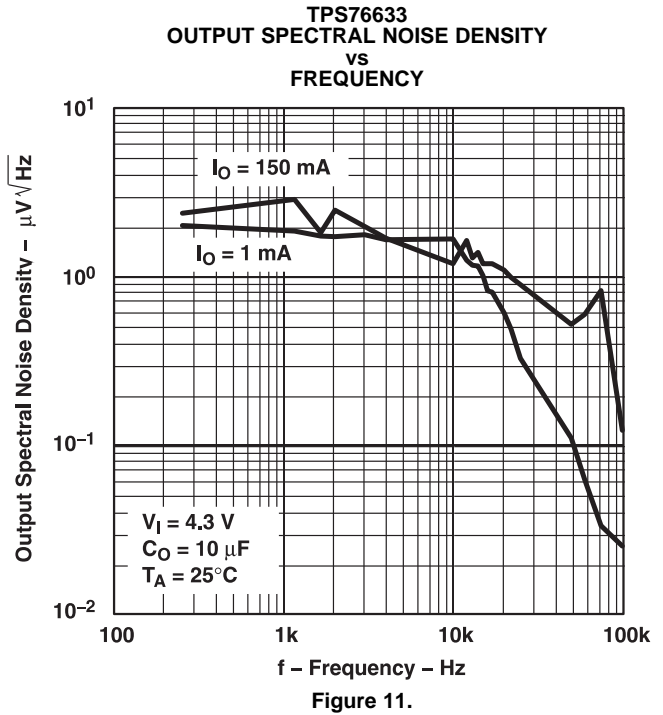
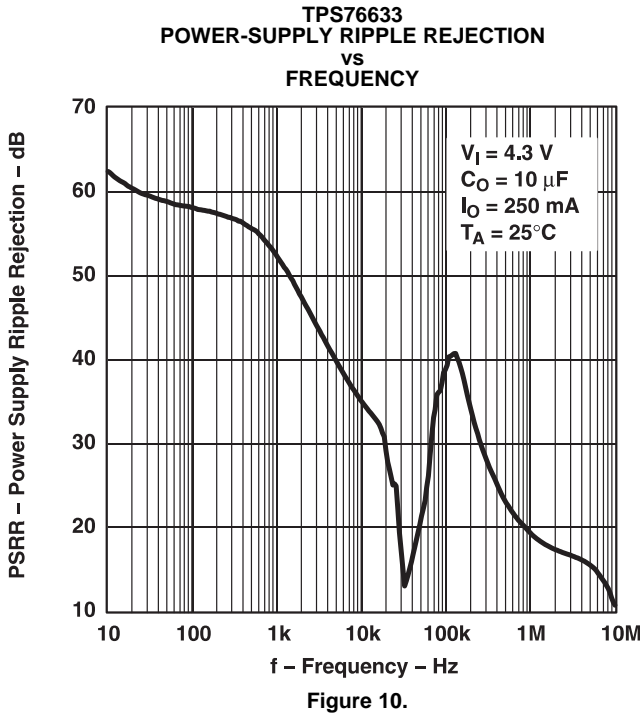
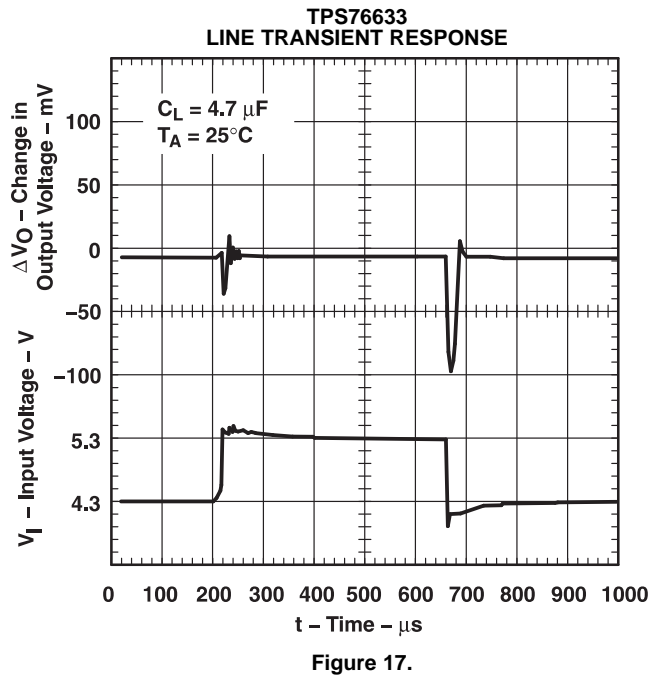
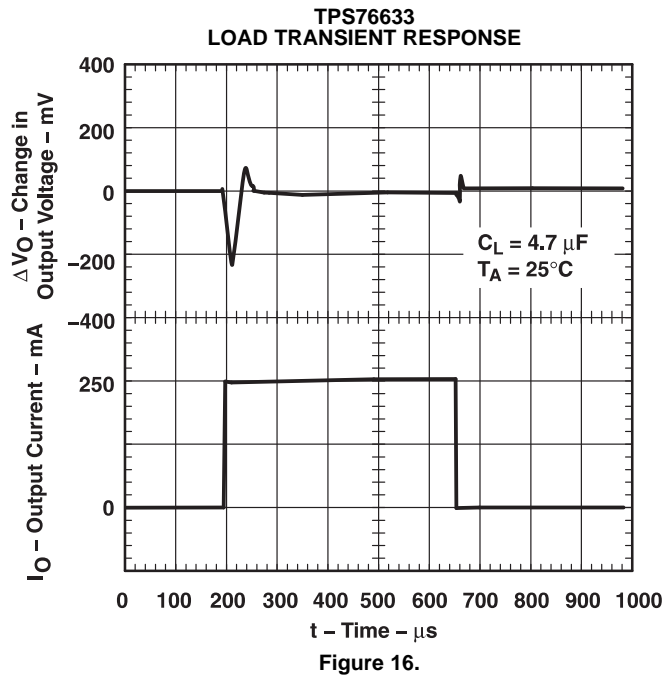
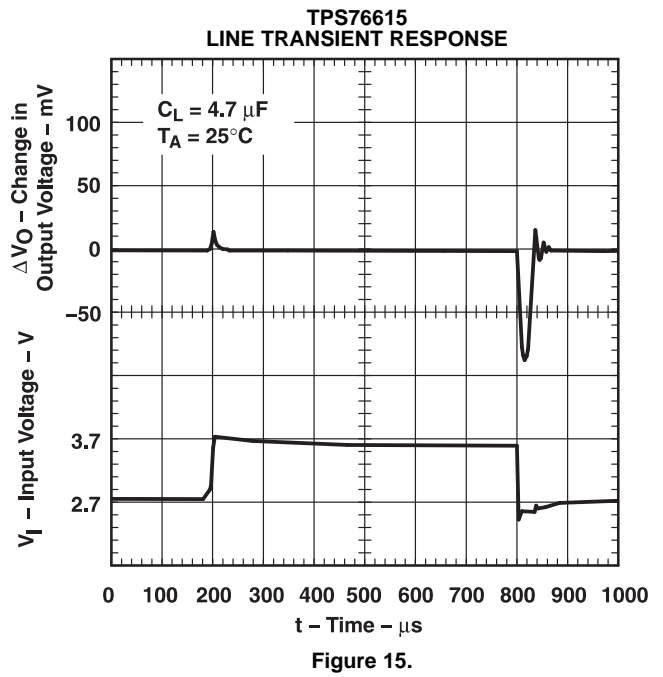
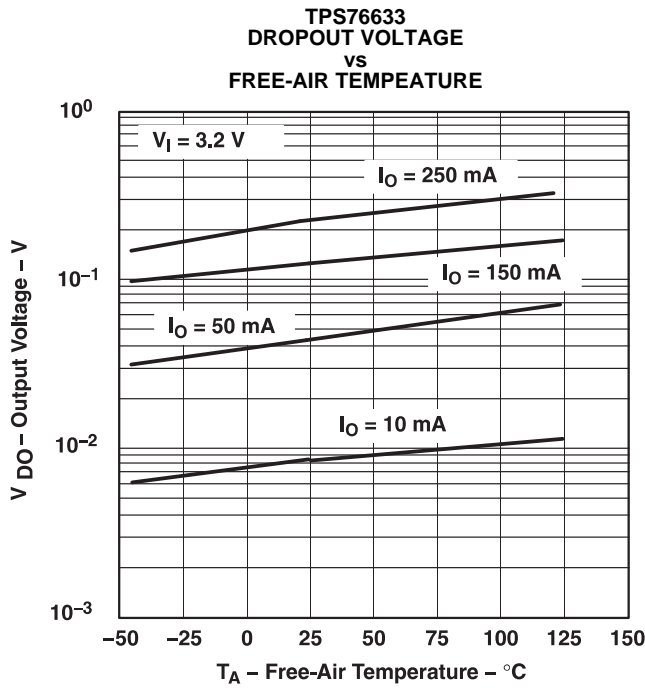

Figure 9.

TYPICAL CHARACTERISTICS (continued)



TYPICAL CHARACTERISTICS (continued)



TYPICAL CHARACTERISTICS (continued)

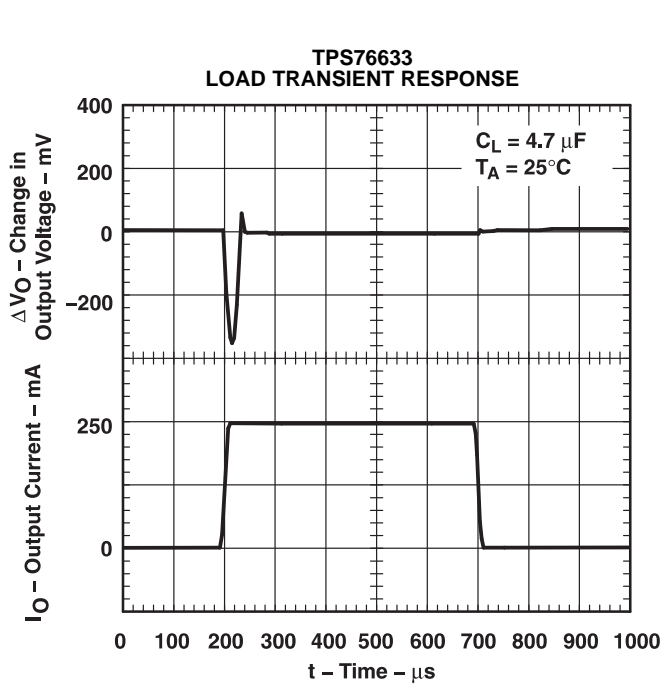

Figure 18.

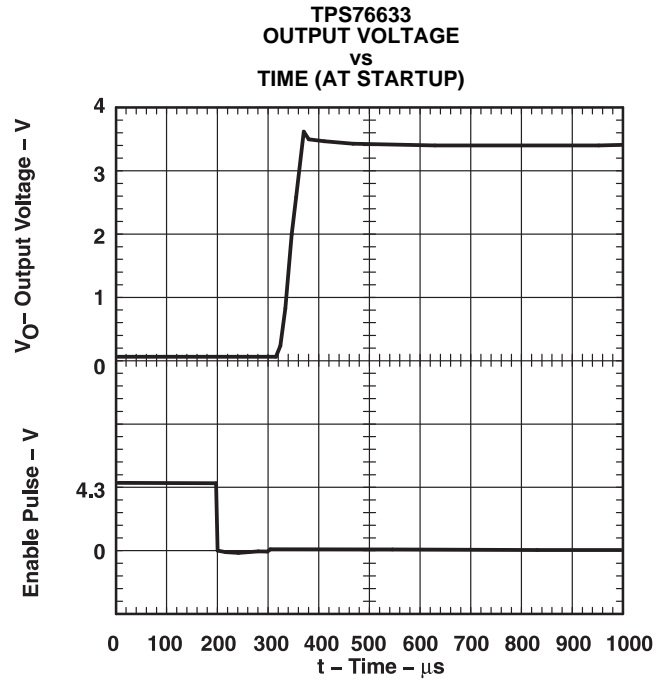

Figure 19.

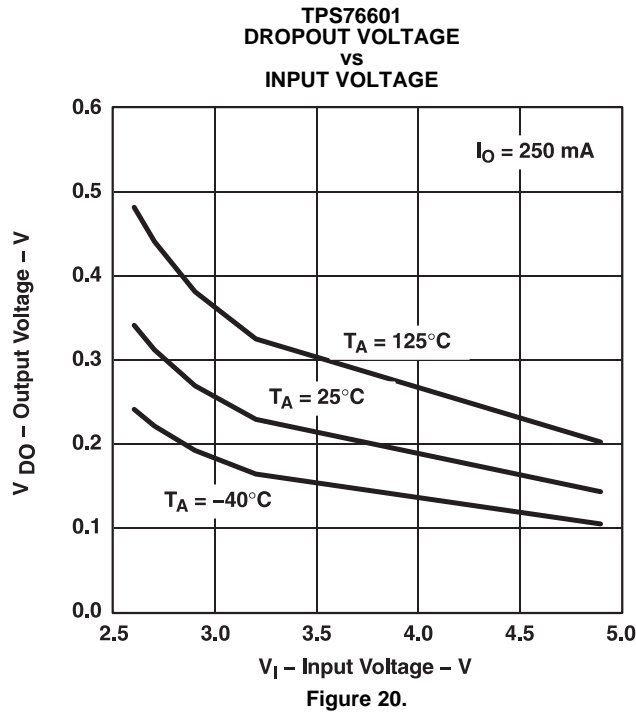

Figure 20.

TYPICAL CHARACTERISTICS (continued)

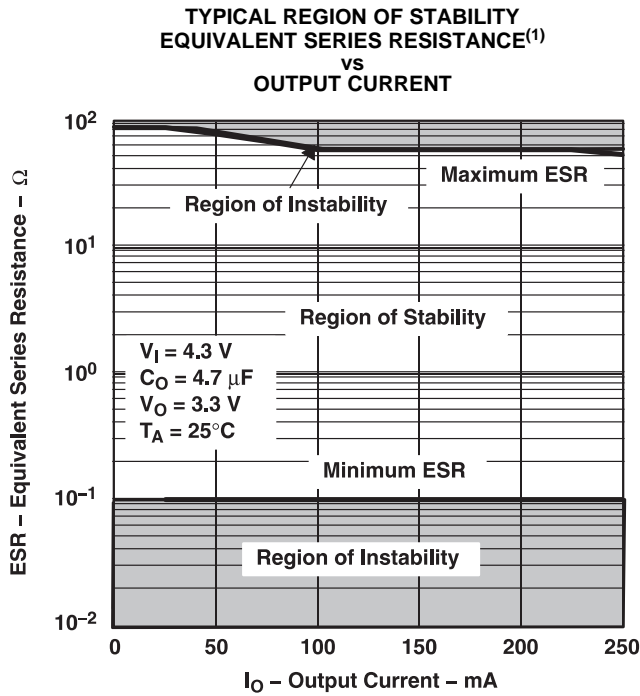

Figure 21.

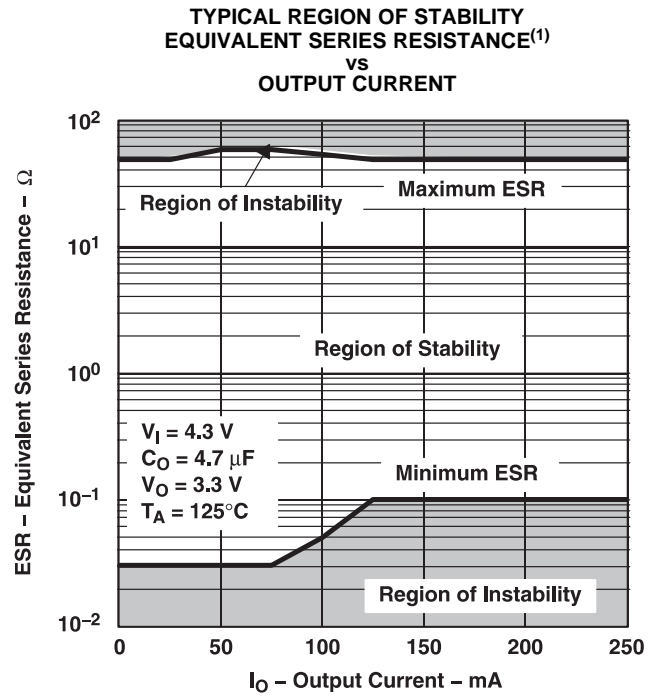

Figure 22.

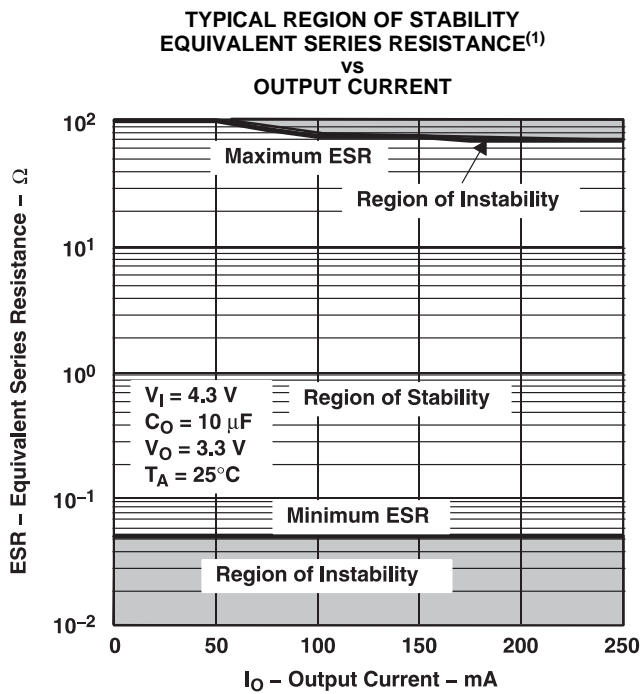

Figure 23.

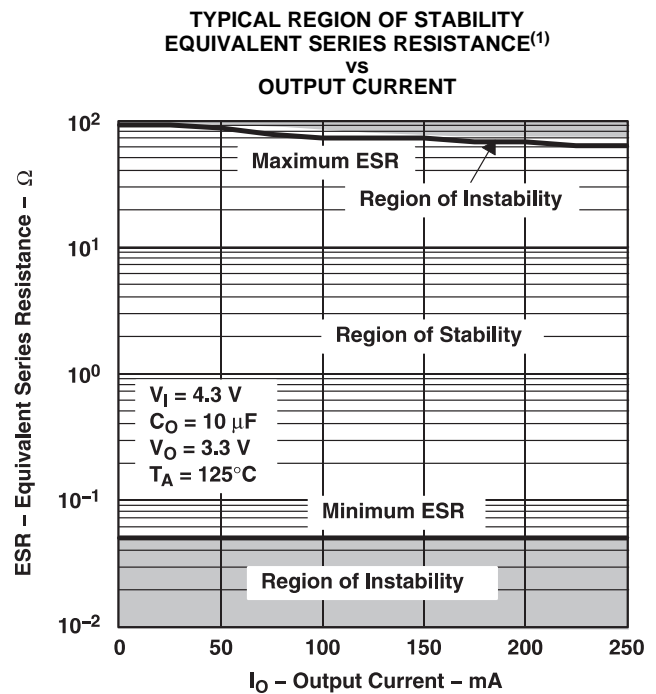

Figure 24.

⁽¹⁾ Equivalent series resistance (ESR) refers to the total series resistance, including the ESR of the capacitor, any series resistance added externally, and PWB trace resistance to C_O .

TYPICAL CHARACTERISTICS (continued)

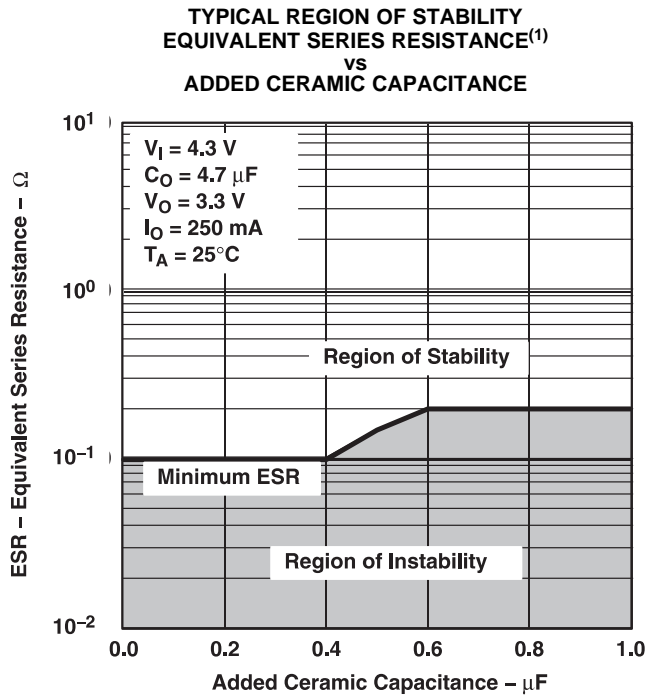

Figure 25.

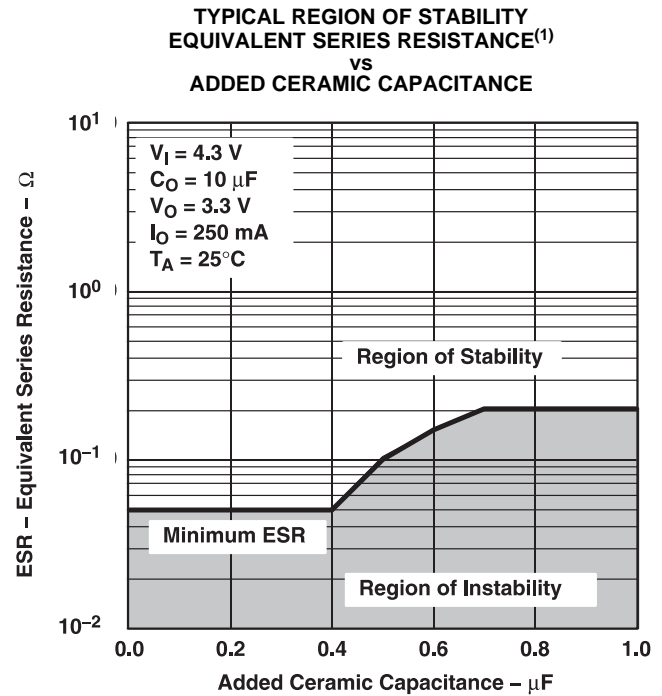

Figure 26.

⁽¹⁾ Equivalent series resistance (ESR) refers to the total series resistance, including the ESR of the capacitor, any series resistance added externally, and PWB trace resistance to C_O .

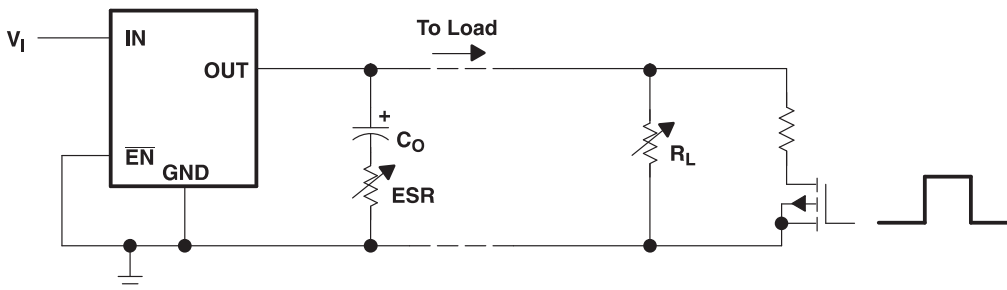

Figure 27. Test Circuit for Typical Regions of Stability (Figure 21 through Figure 24) (Fixed Output Options)

APPLICATION INFORMATION

The TPS766xx family includes eight fixed-output voltage regulators (1.5 V, 1.8 V, 2.5 V, 2.7 V, 2.8 V, 3.0 V, 3.3 V, and 5.0 V), and an adjustable regulator, the TPS76601 (adjustable from 1.25 V to 5.5 V).

DEVICE OPERATION

The TPS766xx features very low quiescent current that remains virtually constant even with varying loads. Conventional LDO regulators use a pnp pass element, the base current of which is directly proportional to the load current through the regulator ($I_B = I_C/\beta$). The TPS766xx uses a PMOS transistor to pass current; because the gate of the PMOS is voltage driven, operating current is low and invariable over the full load range.

Another pitfall associated with the pnp pass element is its tendency to saturate when the device goes into dropout. The resulting drop in β forces an increase in I_B to maintain the load. During power up, this increase in I_B translates to large start-up currents. Systems with limited supply current may fail to start up. In battery-powered systems, it means rapid battery discharge when the voltage decays below the minimum required for regulation. The TPS766xx quiescent current remains low even when the regulator drops out, eliminating both problems.

The TPS766xx family also features a shutdown mode that places the output in the high-impedance state (essentially equal to the feedback-divider resistance) and reduces quiescent current to 1 μ A (typ). If the shutdown feature is not used, EN should be tied to ground. Response to an enable transition is quick; regulated output voltage is reestablished in typically 160 μ s.

MINIMUM LOAD REQUIREMENTS

The TPS766xx family is stable even at zero load; no minimum load is required for operation.

FB—PIN CONNECTION (ADJUSTABLE VERSION ONLY)

The FB pin is an input pin to sense the output voltage and close the loop for the adjustable option. The output voltage is sensed through a resistor divider network to close the loop as shown in [Figure 29](#). Normally, this connection should be as short as possible; however, the connection can be made near a critical circuit to improve performance at that point. Internally, FB connects to a high-impedance, wide-bandwidth amplifier and noise pickup feeds through to the regulator output. Routing the FB connection to minimize or avoid noise pickup is essential.

EXTERNAL CAPACITOR REQUIREMENTS

An input capacitor is not usually required; however, a ceramic bypass capacitor (0.047 μ F or larger) improves load transient response and noise rejection if the TPS766xx is located more than a few inches from the power supply. A higher-capacitance electrolytic capacitor may be necessary if large (hundreds of milliamps) load transients with fast rise times are anticipated.

Like most low dropout regulators, the TPS766xx requires an output capacitor connected between OUT and GND to stabilize the internal control loop. The minimum recommended capacitance value is 4.7 μ F and the ESR (equivalent series resistance) must be between 300 m Ω and 20 Ω . Capacitor values 4.7 μ F or larger are acceptable, provided the ESR is less than 20 Ω . Solid tantalum electrolytic and aluminum electrolytic capacitors are all suitable, provided they meet the requirements described previously. Ceramic capacitors, with series resistors that are sized to meet the previously described requirements, may also be used.

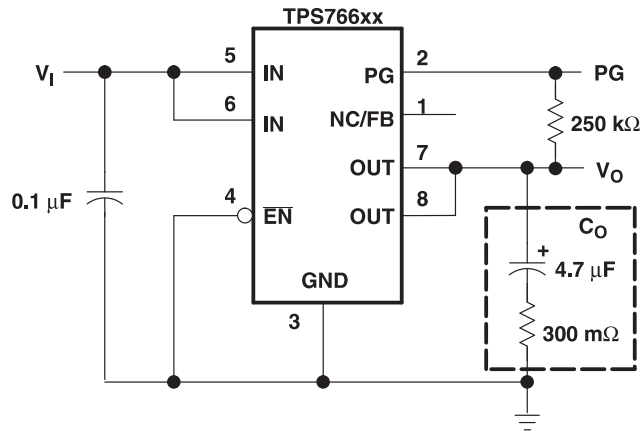

Figure 28. Typical Application Circuit (Fixed Versions)

PROGRAMMING THE TPS76601 ADJUSTABLE LDO REGULATOR

The output voltage of the TPS76601 adjustable regulator is programmed using an external resistor divider as shown in Figure 29. The output voltage is calculated using:

$$V_O = V_{ref} \times \left(1 + \frac{R1}{R2}\right) \quad (1)$$

Where:

- $V_{ref} = 1.224 \text{ V typ}$ (the internal reference voltage)

Resistors R1 and R2 should be chosen for approximately 7-μA divider current. Lower value resistors can be used but offer no inherent advantage and waste more power. Higher values should be avoided because leakage currents at FB increase the output voltage error. The recommended design procedure is to choose $R2 = 169 \text{ k}\Omega$ to set the divider current at 7 μA, and then calculate R1 using:

$$R1 = \left(\frac{V_O}{V_{ref}} - 1\right) \times R2 \quad (2)$$

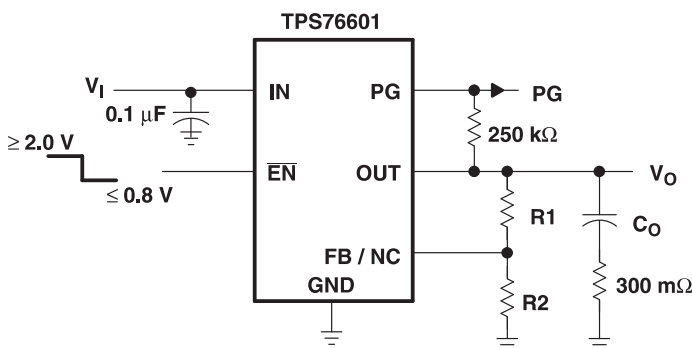

OUTPUT VOLTAGE PROGRAMMING GUIDE

OUTPUT VOLTAGE	R1	R2	UNIT
2.5 V	174	169	kΩ
3.3 V	287	169	kΩ
3.6 V	324	169	kΩ
4.0 V	383	169	kΩ
5.0 V	523	169	kΩ

Figure 29. TPS76601 Adjustable LDO Regulator Programming

POWER-GOOD INDICATOR

The TPS766xx features a power-good (PG) output that can be used to monitor the status of the regulator. The internal comparator monitors the output voltage: when the output drops to between 92% and 98% of its nominal regulated value, the PG output transistor turns on, taking the signal low. The open-drain output requires a pullup resistor. If not used, it can be left floating. PG can be used to drive power-on reset circuitry or used as a low-battery indicator.

REGULATOR PROTECTION

The TPS766xx PMOS-pass transistor has a built-in back diode that conducts reverse currents when the input voltage drops below the output voltage (for example, during power down). Current is conducted from the output to the input and is not internally limited. When extended reverse voltage is anticipated, external limiting may be appropriate.

The TPS766xx also features internal current limiting and thermal protection. During normal operation, the TPS766xx limits output current to approximately 0.8 A (typ). When current limiting engages, the output voltage scales back linearly until the overcurrent condition ends. While current limiting is designed to prevent gross device failure, care should be taken not to exceed the power dissipation ratings of the package. If the temperature of the device exceeds +150°C (typ), thermal-protection circuitry shuts it down. Once the device has cooled below +130°C (typ), regulator operation resumes.

POWER DISSIPATION AND JUNCTION TEMPERATURE

Specified regulator operation is assured to a junction temperature of +125°C; the maximum junction temperature should be restricted to +125°C under normal operating conditions. This restriction limits the power dissipation the regulator can handle in any given application. To ensure the junction temperature is within acceptable limits, calculate the maximum allowable dissipation, $P_{D(max)}$, and the actual dissipation, P_D , which must be less than or equal to $P_{D(max)}$.

The maximum-power-dissipation limit is determined using the following equation:

$$P_{D(max)} = \frac{T_{Jmax} - T_A}{R_{\theta JA}} \quad (3)$$

Where:

- T_{Jmax} is the maximum allowable junction temperature;
- $R_{\theta JA}$ is the thermal resistance junction-to-ambient for the package (that is, 176°C/W for the 8-terminal SOIC); and
- T_A is the ambient temperature.

The regulator dissipation is calculated using:

$$P_D = (V_I - V_O) \times I_O \quad (4)$$

Power dissipation resulting from quiescent current is negligible. Excessive power dissipation triggers the thermal protection circuit.

PACKAGING INFORMATION

Orderable Device	Status (1)	Package Type	Package Drawing	Pins	Package Qty	Eco Plan (2)	Lead finish/ Ball material (6)	MSL Peak Temp (3)	Op Temp (°C)	Device Marking (4/5)	Samples
TPS76601D	ACTIVE	SOIC	D	8	75	RoHS & Green	NIPDAU	Level-1-260C-UNLIM		76601	Samples
TPS76601DG4	ACTIVE	SOIC	D	8	75	RoHS & Green	NIPDAU	Level-1-260C-UNLIM		76601	Samples
TPS76601DR	ACTIVE	SOIC	D	8	2500	RoHS & Green	NIPDAU	Level-1-260C-UNLIM		76601	Samples
TPS76615D	ACTIVE	SOIC	D	8	75	RoHS & Green	NIPDAU	Level-1-260C-UNLIM		76615	Samples
TPS76615DR	ACTIVE	SOIC	D	8	2500	RoHS & Green	NIPDAU	Level-1-260C-UNLIM		76615	Samples
TPS76618D	ACTIVE	SOIC	D	8	75	RoHS & Green	NIPDAU	Level-1-260C-UNLIM		76618	Samples
TPS76618DR	ACTIVE	SOIC	D	8	2500	RoHS & Green	NIPDAU	Level-1-260C-UNLIM		76618	Samples
TPS76625D	ACTIVE	SOIC	D	8	75	RoHS & Green	NIPDAU	Level-1-260C-UNLIM		76625	Samples
TPS76625DR	ACTIVE	SOIC	D	8	2500	RoHS & Green	NIPDAU	Level-1-260C-UNLIM		76625	Samples
TPS76628D	ACTIVE	SOIC	D	8	75	RoHS & Green	NIPDAU	Level-1-260C-UNLIM		76628	Samples
TPS76628DR	ACTIVE	SOIC	D	8	2500	RoHS & Green	NIPDAU	Level-1-260C-UNLIM		76628	Samples
TPS76630D	ACTIVE	SOIC	D	8	75	RoHS & Green	NIPDAU	Level-1-260C-UNLIM		76630	Samples
TPS76633D	ACTIVE	SOIC	D	8	75	RoHS & Green	NIPDAU	Level-1-260C-UNLIM	-40 to 125	76633	Samples
TPS76633DG4	ACTIVE	SOIC	D	8	75	RoHS & Green	NIPDAU	Level-1-260C-UNLIM	-40 to 125	76633	Samples
TPS76633DR	ACTIVE	SOIC	D	8	2500	RoHS & Green	NIPDAU	Level-1-260C-UNLIM	-40 to 125	76633	Samples
TPS76650D	ACTIVE	SOIC	D	8	75	RoHS & Green	NIPDAU	Level-1-260C-UNLIM		76650	Samples
TPS76650DR	ACTIVE	SOIC	D	8	2500	RoHS & Green	NIPDAU	Level-1-260C-UNLIM		76650	Samples
TPS76650DRG4	ACTIVE	SOIC	D	8	2500	RoHS & Green	NIPDAU	Level-1-260C-UNLIM		76650	Samples

⁽¹⁾ The marketing status values are defined as follows:

ACTIVE: Product device recommended for new designs.

LIFEBUY: TI has announced that the device will be discontinued, and a lifetime-buy period is in effect.

NRND: Not recommended for new designs. Device is in production to support existing customers, but TI does not recommend using this part in a new design.

PREVIEW: Device has been announced but is not in production. Samples may or may not be available.

OBSOLETE: TI has discontinued the production of the device.

⁽²⁾ **RoHS:** TI defines "RoHS" to mean semiconductor products that are compliant with the current EU RoHS requirements for all 10 RoHS substances, including the requirement that RoHS substance do not exceed 0.1% by weight in homogeneous materials. Where designed to be soldered at high temperatures, "RoHS" products are suitable for use in specified lead-free processes. TI may reference these types of products as "Pb-Free".

RoHS Exempt: TI defines "RoHS Exempt" to mean products that contain lead but are compliant with EU RoHS pursuant to a specific EU RoHS exemption.

Green: TI defines "Green" to mean the content of Chlorine (Cl) and Bromine (Br) based flame retardants meet JS709B low halogen requirements of ≤ 1000 ppm threshold. Antimony trioxide based flame retardants must also meet the ≤ 1000 ppm threshold requirement.

⁽³⁾ **MSL, Peak Temp.** - The Moisture Sensitivity Level rating according to the JEDEC industry standard classifications, and peak solder temperature.

⁽⁴⁾ There may be additional marking, which relates to the logo, the lot trace code information, or the environmental category on the device.

⁽⁵⁾ Multiple Device Markings will be inside parentheses. Only one Device Marking contained in parentheses and separated by a "~" will appear on a device. If a line is indented then it is a continuation of the previous line and the two combined represent the entire Device Marking for that device.

⁽⁶⁾ **Lead finish/Ball material** - Orderable Devices may have multiple material finish options. Finish options are separated by a vertical ruled line. Lead finish/Ball material values may wrap to two lines if the finish value exceeds the maximum column width.

Important Information and Disclaimer: The information provided on this page represents TI's knowledge and belief as of the date that it is provided. TI bases its knowledge and belief on information provided by third parties, and makes no representation or warranty as to the accuracy of such information. Efforts are underway to better integrate information from third parties. TI has taken and continues to take reasonable steps to provide representative and accurate information but may not have conducted destructive testing or chemical analysis on incoming materials and chemicals. TI and TI suppliers consider certain information to be proprietary, and thus CAS numbers and other limited information may not be available for release.

In no event shall TI's liability arising out of such information exceed the total purchase price of the TI part(s) at issue in this document sold by TI to Customer on an annual basis.

TAPE AND REEL INFORMATION

QUADRANT ASSIGNMENTS FOR PIN 1 ORIENTATION IN TAPE

*All dimensions are nominal

Device	Package Type	Package Drawing	Pins	SPQ	Reel Diameter (mm)	Reel Width W1 (mm)	A0 (mm)	B0 (mm)	K0 (mm)	P1 (mm)	W (mm)	Pin1 Quadrant
TPS76601DR	SOIC	D	8	2500	330.0	12.4	6.4	5.2	2.1	8.0	12.0	Q1
TPS76615DR	SOIC	D	8	2500	330.0	12.4	6.4	5.2	2.1	8.0	12.0	Q1
TPS76618DR	SOIC	D	8	2500	330.0	12.4	6.4	5.2	2.1	8.0	12.0	Q1
TPS76625DR	SOIC	D	8	2500	330.0	12.4	6.4	5.2	2.1	8.0	12.0	Q1
TPS76628DR	SOIC	D	8	2500	330.0	12.4	6.4	5.2	2.1	8.0	12.0	Q1
TPS76633DR	SOIC	D	8	2500	330.0	12.4	6.4	5.2	2.1	8.0	12.0	Q1
TPS76650DR	SOIC	D	8	2500	330.0	12.4	6.4	5.2	2.1	8.0	12.0	Q1

TAPE AND REEL BOX DIMENSIONS

*All dimensions are nominal

Device	Package Type	Package Drawing	Pins	SPQ	Length (mm)	Width (mm)	Height (mm)
TPS76601DR	SOIC	D	8	2500	350.0	350.0	43.0
TPS76615DR	SOIC	D	8	2500	350.0	350.0	43.0
TPS76618DR	SOIC	D	8	2500	350.0	350.0	43.0
TPS76625DR	SOIC	D	8	2500	350.0	350.0	43.0
TPS76628DR	SOIC	D	8	2500	350.0	350.0	43.0
TPS76633DR	SOIC	D	8	2500	356.0	356.0	35.0
TPS76650DR	SOIC	D	8	2500	350.0	350.0	43.0

TUBE

*All dimensions are nominal

Device	Package Name	Package Type	Pins	SPQ	L (mm)	W (mm)	T (μm)	B (mm)
TPS76601D	D	SOIC	8	75	505.46	6.76	3810	4
TPS76601DG4	D	SOIC	8	75	505.46	6.76	3810	4
TPS76615D	D	SOIC	8	75	505.46	6.76	3810	4
TPS76618D	D	SOIC	8	75	505.46	6.76	3810	4
TPS76625D	D	SOIC	8	75	505.46	6.76	3810	4
TPS76628D	D	SOIC	8	75	505.46	6.76	3810	4
TPS76630D	D	SOIC	8	75	505.46	6.76	3810	4
TPS76633D	D	SOIC	8	75	506.6	8	3940	4.32
TPS76633D	D	SOIC	8	75	505.46	6.76	3810	4
TPS76633DG4	D	SOIC	8	75	506.6	8	3940	4.32
TPS76633DG4	D	SOIC	8	75	505.46	6.76	3810	4
TPS76650D	D	SOIC	8	75	505.46	6.76	3810	4



D0008A

PACKAGE OUTLINE

SOIC - 1.75 mm max height

SMALL OUTLINE INTEGRATED CIRCUIT



4214825/C 02/2019

NOTES:

1. Linear dimensions are in inches [millimeters]. Dimensions in parenthesis are for reference only. Controlling dimensions are in inches. Dimensioning and tolerancing per ASME Y14.5M.
2. This drawing is subject to change without notice.
3. This dimension does not include mold flash, protrusions, or gate burrs. Mold flash, protrusions, or gate burrs shall not exceed $.006$ [0.15] per side.
4. This dimension does not include interlead flash.
5. Reference JEDEC registration MS-012, variation AA.

EXAMPLE BOARD LAYOUT

D0008A

SOIC - 1.75 mm max height

SMALL OUTLINE INTEGRATED CIRCUIT



LAND PATTERN EXAMPLE
EXPOSED METAL SHOWN
SCALE:8X



SOLDER MASK DETAILS

4214825/C 02/2019

NOTES: (continued)

- 6. Publication IPC-7351 may have alternate designs.
- 7. Solder mask tolerances between and around signal pads can vary based on board fabrication site.

EXAMPLE STENCIL DESIGN

D0008A

SOIC - 1.75 mm max height

SMALL OUTLINE INTEGRATED CIRCUIT



SOLDER PASTE EXAMPLE
BASED ON .005 INCH [0.125 MM] THICK STENCIL
SCALE:8X

4214825/C 02/2019

NOTES: (continued)

8. Laser cutting apertures with trapezoidal walls and rounded corners may offer better paste release. IPC-7525 may have alternate design recommendations.
9. Board assembly site may have different recommendations for stencil design.

IMPORTANT NOTICE AND DISCLAIMER

TI PROVIDES TECHNICAL AND RELIABILITY DATA (INCLUDING DATA SHEETS), DESIGN RESOURCES (INCLUDING REFERENCE DESIGNS), APPLICATION OR OTHER DESIGN ADVICE, WEB TOOLS, SAFETY INFORMATION, AND OTHER RESOURCES "AS IS" AND WITH ALL FAULTS, AND DISCLAIMS ALL WARRANTIES, EXPRESS AND IMPLIED, INCLUDING WITHOUT LIMITATION ANY IMPLIED WARRANTIES OF MERCHANTABILITY, FITNESS FOR A PARTICULAR PURPOSE OR NON-INFRINGEMENT OF THIRD PARTY INTELLECTUAL PROPERTY RIGHTS.

These resources are intended for skilled developers designing with TI products. You are solely responsible for (1) selecting the appropriate TI products for your application, (2) designing, validating and testing your application, and (3) ensuring your application meets applicable standards, and any other safety, security, regulatory or other requirements.

These resources are subject to change without notice. TI grants you permission to use these resources only for development of an application that uses the TI products described in the resource. Other reproduction and display of these resources is prohibited. No license is granted to any other TI intellectual property right or to any third party intellectual property right. TI disclaims responsibility for, and you will fully indemnify TI and its representatives against, any claims, damages, costs, losses, and liabilities arising out of your use of these resources.

TI's products are provided subject to [TI's Terms of Sale](#) or other applicable terms available either on ti.com or provided in conjunction with such TI products. TI's provision of these resources does not expand or otherwise alter TI's applicable warranties or warranty disclaimers for TI products.

TI objects to and rejects any additional or different terms you may have proposed.

Mailing Address: Texas Instruments, Post Office Box 655303, Dallas, Texas 75265
Copyright © 2022, Texas Instruments Incorporated