

RPM6900 series are remote control receiver modules. Small-sized and light-weight modules have been achieved by using resin mold.

●Applications

All household electric appliances such as TV, DVD, air conditioner and audio equipment.

●Features

- 1) Good EMI noise shielding characteristics.
- 2) Excellent sun light noise shielding performance.
- 3) Built-in electric-magnetic shield no requiring shield-casing.

●RPM6900 series list

	Height to lens	5.5mm	4.8mm
	Frequency (kHz)	Straight Type RSIP-A3	L forming RSIP-A3 V4
Product No.	36.7	RPM6937	RPM6937-V4
	37.9	RPM6938	RPM6938-V4
	40.0	RPM6940	RPM6940-V4

●Absolute maximum ratings (Ta = 25°C)

Parameter	Symbol	Limits	Unit
Supply Voltage	Vcc	6.3	V
Output Current	Io	2.5	mA
Storage temperature	Tstg	-30 to +100	°C
Operating temperature	Topr	-10 to +75	°C

●Recommended operating conditions (Ta = 25°C)

Parameter	Symbol	Min.	Typ.	Max.	Unit
Supply Voltage	Vcc	4.5	5.0	5.5	V

●Block diagram

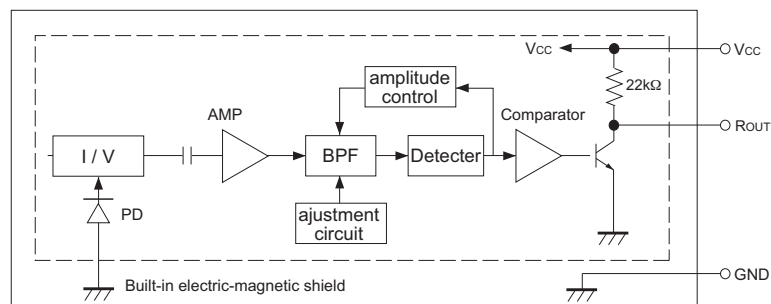

●Terminal description

Pin No.	Pin name	Function
1	Rout	OUTPUT TERMINAL
2	GND	GROUND
3	Vcc	POWER SUPPLY

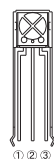

●Electrical, Optical characteristics (Unless otherwise noted, Ta = 25°C Vcc=5V)

Parameter	Symbol	Min.	Typ.	Max.	Unit	Conditions
Consumption Current	I _{CC}	-	1.5	2.0	mA	No outside light, No signal input
Effective Distance	L	10	16	-	m	Outer light condition E _e < 10 (lx) *1
High Level Output Voltage	V _H	4.5	-	-	V	*1
Low Level Output Voltage	V _L	-	-	0.5	V	I _{sink} ≤ 400μA *1
ON Pulse Width	T _{ON}	400	600	800	μs	Outer light condition E _e < 10 (lx) *1
OFF Pulse Width	T _{OFF}	400	600	800	μs	Outer light condition E _e < 10 (lx) *1
Center frequency	f _o	-	*3	-	kHz	
Horizontal half angle	θ 80%	-	35	-	deg	*2
Vertical half angle	θ 80%	-	30	-	deg	*2

*1 600/600μs burst wave is transmitted by standard transmitter. However, it must be measured after the initial transmission pulse is 10 pulse.

*2 It is an angle when the linear arrival distance become 80%.

*3 RPM6937 36.7kHz
 RPM6938 37.8kHz
 RPM6940 40.0kHz

● Measurement Conditions

(1) Transmit signal

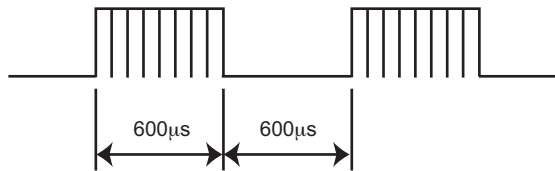

Carrier frequency=f_o, Duty=50%

Fig.1 Transmit signal

(2) Standard transmitter

λ peak=940nm
 λ Δ=40nm

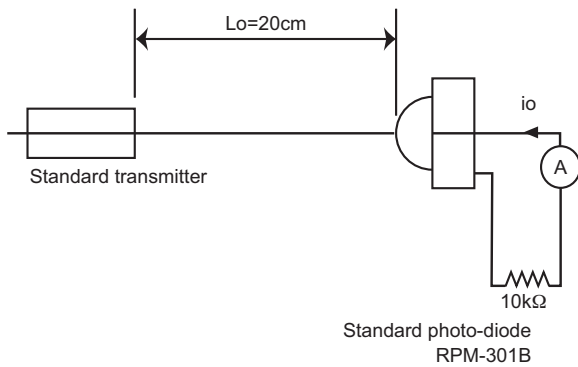

Fig.2 Measurement of standard transmitter proofreading

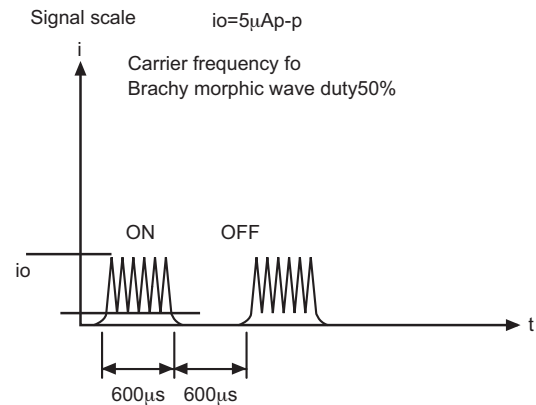

Fig.3 Standard photo diode current

When standard transmitter output the signal at Fig.1 standard photodiode output become i_o=5μAp-p (Fig.3) under the measurement condition Fig.2.

(The radiant intensity of standard transmitter : 50mW / sr)

RPM-301B : standard photodiode has short current I_{sc}=27μA at E=1000(lx)
 (using CIE standard light source A)

(3) Measurement effective distance, horizontal & vertical half angle

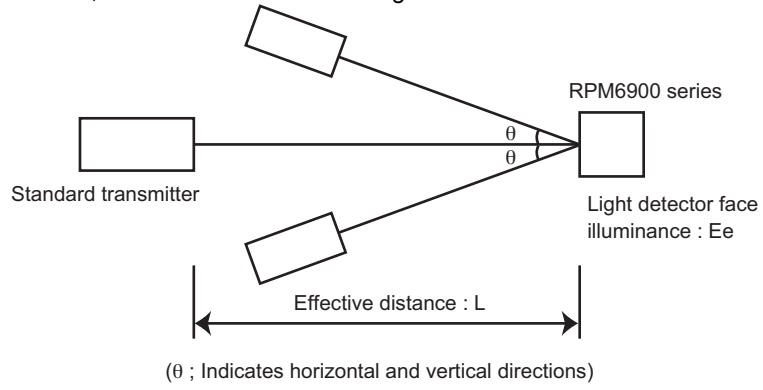

Fig.4 Measurement condition for effective distance

Effective distance L : Effective distance at $\theta=0^\circ$ Fig.4
 Horizontal & vertical half angle θ : The angle which effective distance became 50% of L .

(4) Output signal

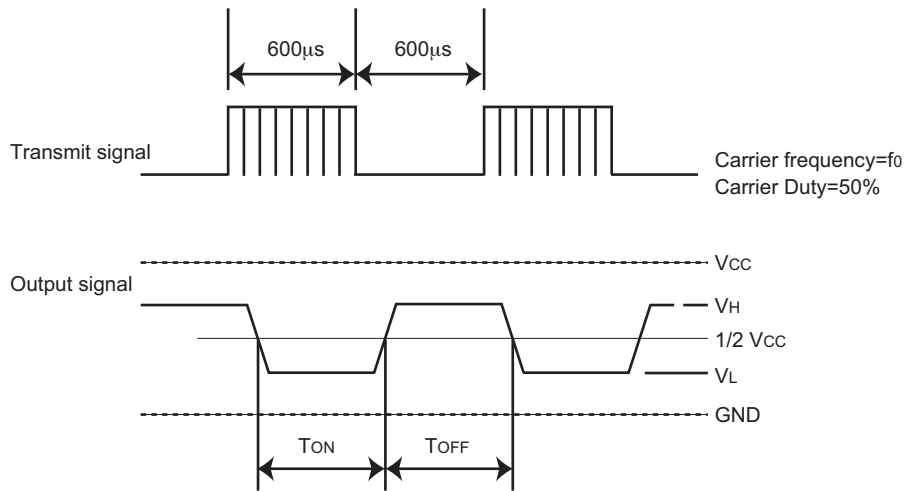

Fig.5

●Notes

(1) All characteristics of the receiver in this specification are specified by supplying burst wave form (Fig.1) with ROHM standard transmitter (Fig.2).

If in case of other burst wave form will be used, please check these spec. Carefully under the evaluations.

(2) When the receiver will be used as the wire-less remote controller, please use the signal method the signal format which refer to "Measures to prevent malfunctioning of IR remote-controlled electric home appliances". (Published July 1987 by Association of Electric Home Appliances)

If using other signal method, signal format, (ex: signal format which not including the leader signal) the receiver might have chances to miss-function.

(3) Please set up transmitter's carrier frequency as same as the receiver's f_0 frequency. Otherwise error might be occurred.

(4) If transmission signal has non-continues carrier, error might be occurred. Continuous carrier is necessary.



(5) The receiver was designed to use as in-door use only.

Therefore, please understand that the receiver cannot cover all characteristics, in case of using it out-door.

(6) Noise environment (Light noise from inverter Lamp, and other kind of Lamps, Power ripple, electromagnetic noise from power circuit, and etc) may cause a reduced effective distance.

(7) The receiver may not work properly if receiving signal judgment is done by single pulse due to the surrounding / environmental noises.

To prevent such misjudgment, please make sure that the receiver is set up to work only when receiving series of coded signal.

(8) Emitting unit (remote control transmitter) has to be considered about its emitting device function, characteristics and characteristics of the receiver.

(9) Do not supply unnecessary stress to lead.

(10) Please pay careful attention to the lens.

It might have a chance to miss-function when the lens get dust or dirty. And also please do not touch the lens.

(11) In order to prevent products from ESD, human body and solder iron, etc. are required to be grounded.

●Electrical and optical characteristics curves

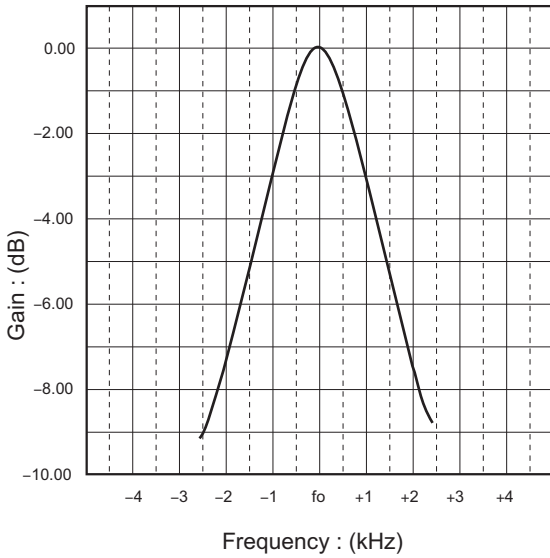

Fig.7 BPF characteristic

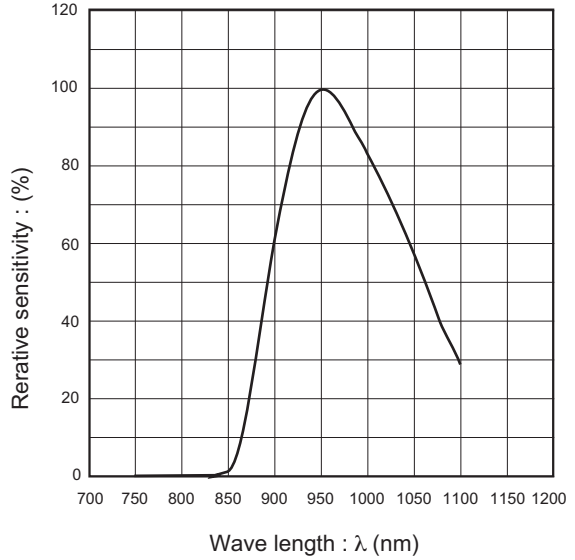

Fig.8 Optical bandwidth of the photo-diode encapsulation

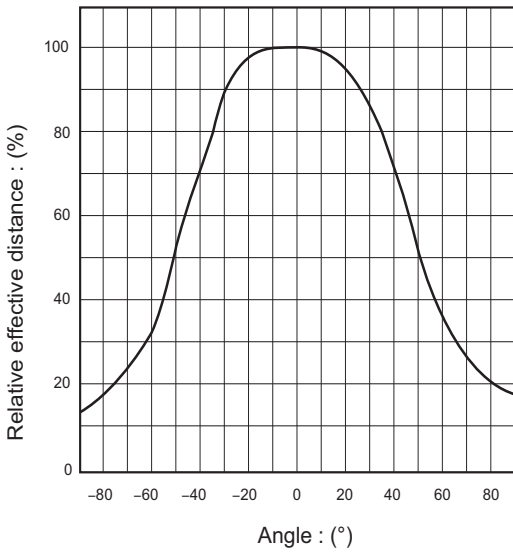

Fig.9 Direction characteristic (Horizontal direction)

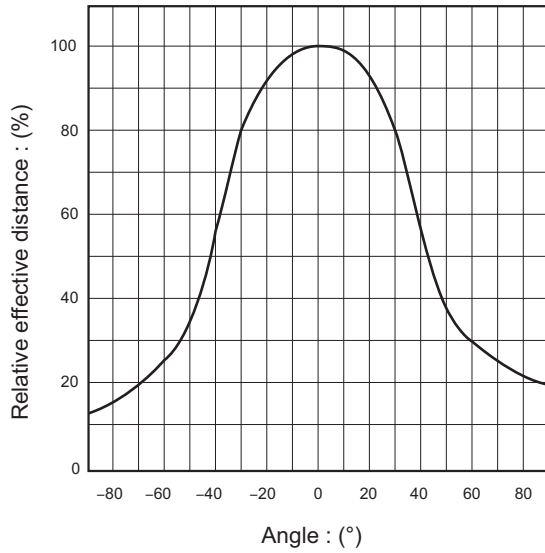
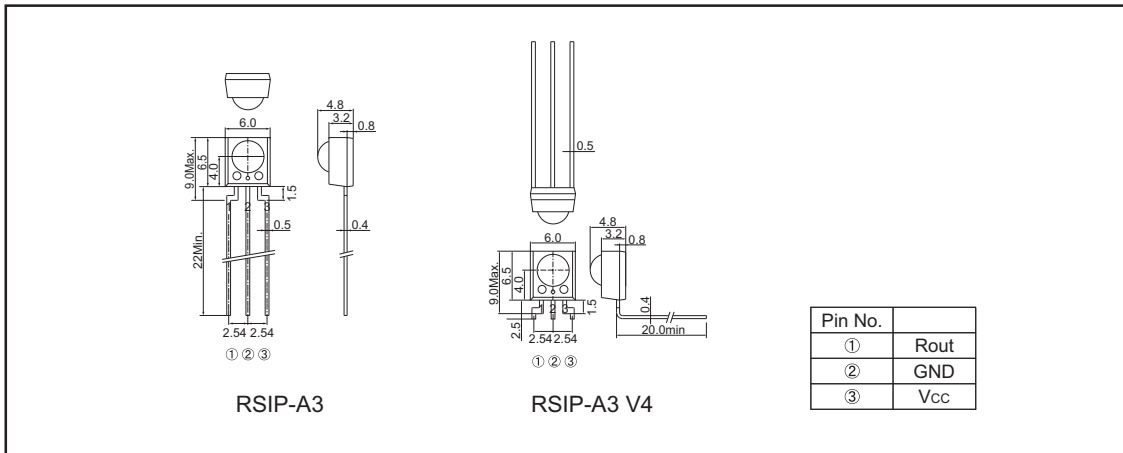

Fig.10 Direction characteristic (Vertical direction)

●Dimensions (Unit : mm)



Notes

- 1) The information contained herein is subject to change without notice.
- 2) Before you use our Products, please contact our sales representative and verify the latest specifications :
- 3) Although ROHM is continuously working to improve product reliability and quality, semiconductors can break down and malfunction due to various factors.
Therefore, in order to prevent personal injury or fire arising from failure, please take safety measures such as complying with the derating characteristics, implementing redundant and fire prevention designs, and utilizing backups and fail-safe procedures. ROHM shall have no responsibility for any damages arising out of the use of our Products beyond the rating specified by ROHM.
- 4) Examples of application circuits, circuit constants and any other information contained herein are provided only to illustrate the standard usage and operations of the Products. The peripheral conditions must be taken into account when designing circuits for mass production.
- 5) The technical information specified herein is intended only to show the typical functions of and examples of application circuits for the Products. ROHM does not grant you, explicitly or implicitly, any license to use or exercise intellectual property or other rights held by ROHM or any other parties. ROHM shall have no responsibility whatsoever for any dispute arising out of the use of such technical information.
- 6) The Products are intended for use in general electronic equipment (i.e. AV/OA devices, communication, consumer systems, gaming/entertainment sets) as well as the applications indicated in this document.
- 7) The Products specified in this document are not designed to be radiation tolerant.
- 8) For use of our Products in applications requiring a high degree of reliability (as exemplified below), please contact and consult with a ROHM representative : transportation equipment (i.e. cars, ships, trains), primary communication equipment, traffic lights, fire/crime prevention, safety equipment, medical systems, servers, solar cells, and power transmission systems.
- 9) Do not use our Products in applications requiring extremely high reliability, such as aerospace equipment, nuclear power control systems, and submarine repeaters.
- 10) ROHM shall have no responsibility for any damages or injury arising from non-compliance with the recommended usage conditions and specifications contained herein.
- 11) ROHM has used reasonable care to ensure the accuracy of the information contained in this document. However, ROHM does not warrants that such information is error-free, and ROHM shall have no responsibility for any damages arising from any inaccuracy or misprint of such information.
- 12) Please use the Products in accordance with any applicable environmental laws and regulations, such as the RoHS Directive. For more details, including RoHS compatibility, please contact a ROHM sales office. ROHM shall have no responsibility for any damages or losses resulting non-compliance with any applicable laws or regulations.
- 13) When providing our Products and technologies contained in this document to other countries, you must abide by the procedures and provisions stipulated in all applicable export laws and regulations, including without limitation the US Export Administration Regulations and the Foreign Exchange and Foreign Trade Act.
- 14) This document, in part or in whole, may not be reprinted or reproduced without prior consent of ROHM.



Thank you for your accessing to ROHM product informations.
More detail product informations and catalogs are available, please contact us.

ROHM Customer Support System

<http://www.rohm.com/contact/>

Mouser Electronics

Authorized Distributor

Click to View Pricing, Inventory, Delivery & Lifecycle Information:

[ROHM Semiconductor:](#)

[RPM6933](#) [RPM6933-V4](#) [RPM6936](#) [RPM6936-V4](#) [RPM6937](#) [RPM6937-V4](#) [RPM6938](#) [RPM6940](#) [RPM6940-V4](#)
[RPM6938-V4](#)