

## EMMA-360

~170° side emitter

### TECHNICAL SPECIFICATIONS:

Dimensions	9.9 x 9.9 mm
Height	5.7 mm
Fastening	glue, pin
ROHS compliant	yes ⓘ

### MATERIAL SPECIFICATIONS:

Component	Type	Material	Colour	Finish
EMMA-360	Single lens	PMMA	clear	

### ORDERING INFORMATION:

Component	Qty in box	MOQ	MPQ	Box weight (kg)
C13055_EMMA-360 » Box size:	5000	300	100	1.6



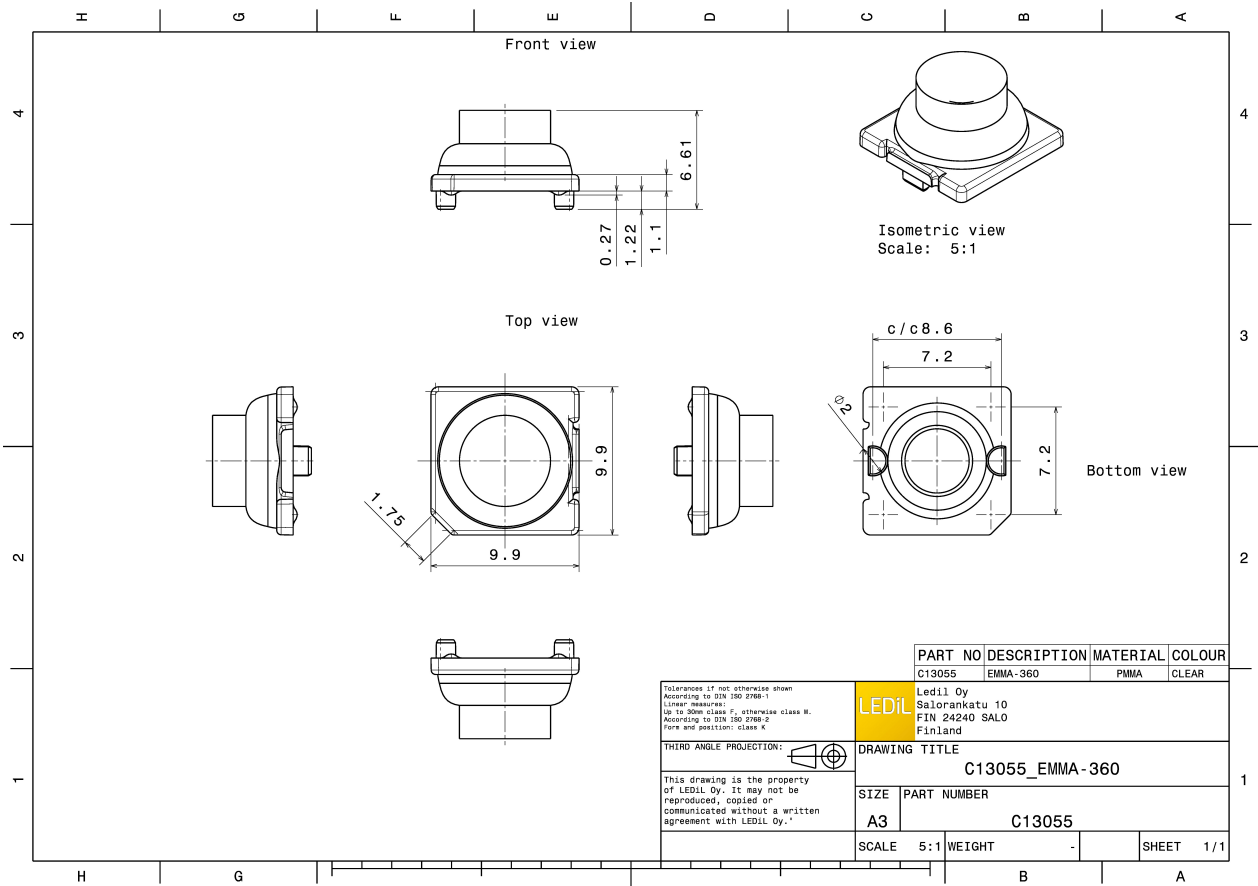

See also our general installation guide: [www.ledil.com/installation\\_guide](http://www.ledil.com/installation_guide)

#### PHOTOMETRIC DATA (MEASURED):

##### CREE LED

LED XB-D  
 FWHM / FWTM 170.0°  
 Efficiency 93 %  
 Peak intensity 0.4 cd/lm  
 LEDs/each optic 1  
 Light colour White  
 Required components:

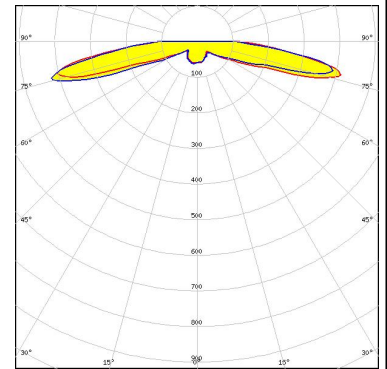

##### CREE LED

LED XP-E2  
 FWHM / FWTM 172.0°  
 Efficiency 94 %  
 Peak intensity 0.4 cd/lm  
 LEDs/each optic 1  
 Light colour White  
 Required components:

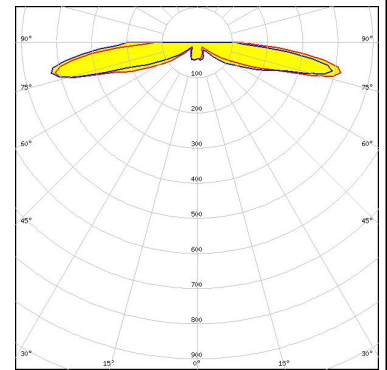

##### CREE LED

LED XP-G  
 FWHM / FWTM 173.0°  
 Efficiency 88 %  
 Peak intensity 0.4 cd/lm  
 LEDs/each optic 1  
 Light colour White  
 Required components:

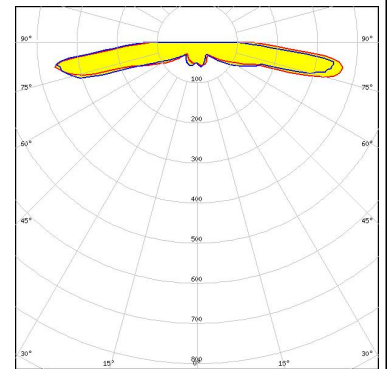

##### CREE LED

LED XP-G2  
 FWHM / FWTM 172.0°  
 Efficiency 90 %  
 Peak intensity 0.4 cd/lm  
 LEDs/each optic 1  
 Light colour White  
 Required components:

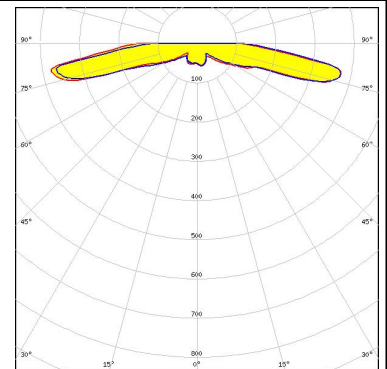

#### PHOTOMETRIC DATA (MEASURED):



LED XT-E  
 FWHM / FWTM 174.0° / 188.0°  
 Efficiency 94 %  
 Peak intensity 0.4 cd/lm  
 LEDs/each optic 1  
 Light colour White  
 Required components:

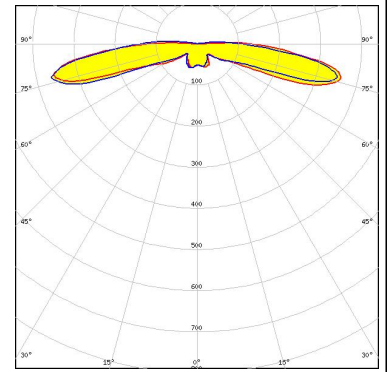

LED LUXEON 3535 2D  
 FWHM / FWTM 170.0°  
 Efficiency 94 %  
 Peak intensity 0.4 cd/lm  
 LEDs/each optic 1  
 Light colour White  
 Required components:

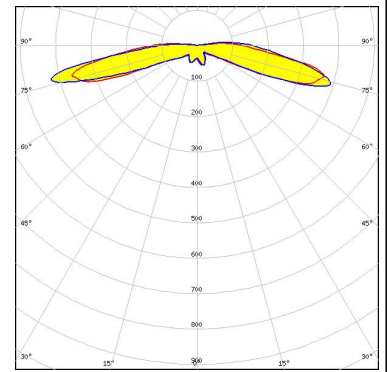

LED LUXEON A  
 FWHM / FWTM 173.0°  
 Efficiency 92 %  
 Peak intensity 0.4 cd/lm  
 LEDs/each optic 1  
 Light colour White  
 Required components:

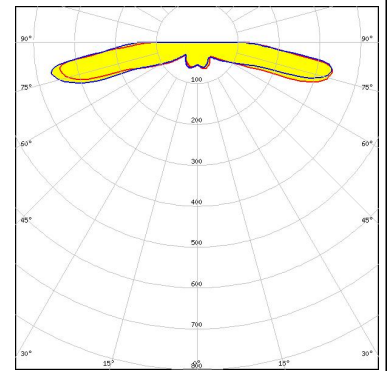

LED LUXEON Rebel  
 FWHM / FWTM 165.0°  
 Efficiency 93 %  
 Peak intensity 0.5 cd/lm  
 LEDs/each optic 1  
 Light colour White  
 Required components:

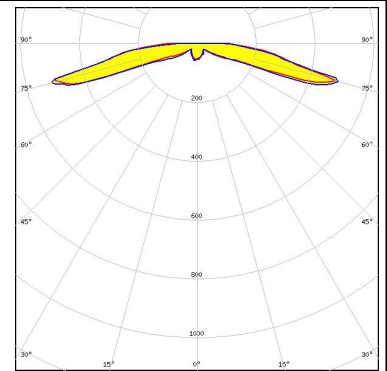

### PHOTOMETRIC DATA (MEASURED):



LED NCSxx19A  
FWHM / FWTM 165.0°  
Efficiency 90 %  
Peak intensity 0.4 cd/lm  
LEDs/each optic 1  
Light colour White  
Required components:

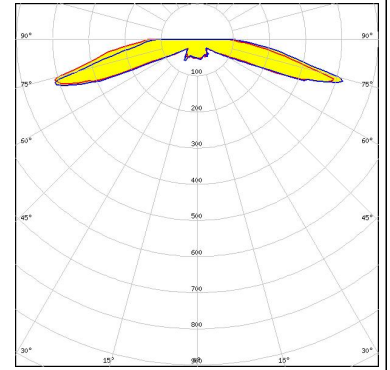

LED OSLON Square EC  
FWHM / FWTM 170.0°  
Efficiency 92 %  
Peak intensity 0.4 cd/lm  
LEDs/each optic 1  
Light colour White  
Required components:

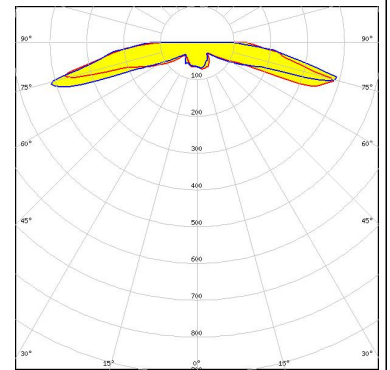

#### PHOTOMETRIC DATA (SIMULATED):



LED J Series 2835  
 FWHM / FWTM 167.0° / 194.0°  
 Efficiency 96 %  
 Peak intensity 0.4 cd/lm  
 LEDs/each optic 1  
 Light colour White  
 Required components:

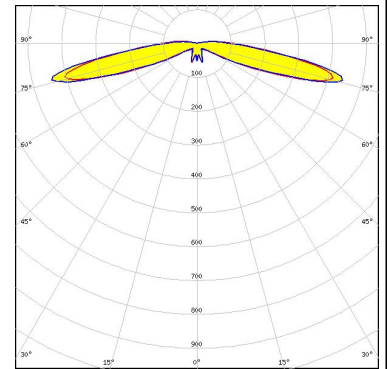

LED J Series 3030  
 FWHM / FWTM 167.0° / 198.0°  
 Efficiency 96 %  
 Peak intensity 0.4 cd/lm  
 LEDs/each optic 1  
 Light colour White  
 Required components:

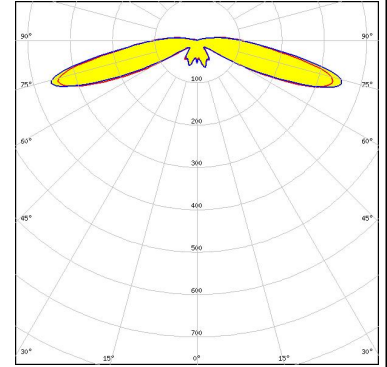

LED XE-G  
 FWHM / FWTM 176.0° / 188.0°  
 Efficiency 96 %  
 Peak intensity 0.4 cd/lm  
 LEDs/each optic 1  
 Light colour Green  
 Required components:

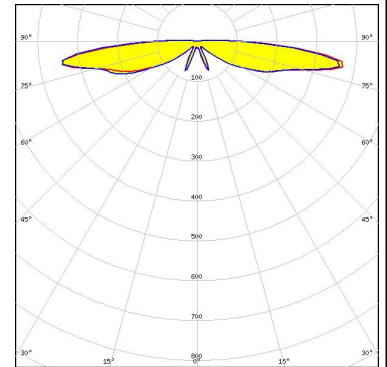

LED XE-G  
 FWHM / FWTM 175.0° / 188.0°  
 Efficiency 96 %  
 Peak intensity 0.4 cd/lm  
 LEDs/each optic 1  
 Light colour White  
 Required components:

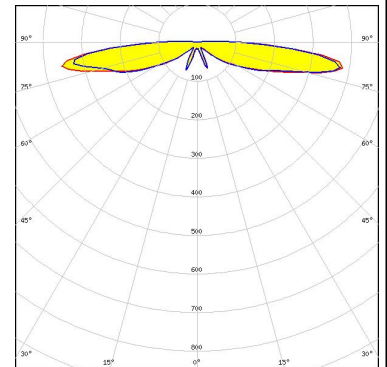

#### PHOTOMETRIC DATA (SIMULATED):

<p><b>CREE</b> LED</p> <p>LED: XQ-E HD            FWHM / FWTM: 172.0° / 189.0°            Efficiency: 97 %            Peak intensity: 0.5 cd/lm            LEDs/each optic: 1            Light colour: Red            Required components:</p>	
<p><b>CREE</b> LED</p> <p>LED: XQ-E HD            FWHM / FWTM: 170.0° / 182.0°            Efficiency: 89 %            Peak intensity: 0.4 cd/lm            LEDs/each optic: 1            Light colour: PC Amber            Required components:</p>	
<p><b>CREE</b> LED</p> <p>LED: XQ-E HD            FWHM / FWTM: 164.0° / 174.0°            Efficiency: 92 %            Peak intensity: 0.5 cd/lm            LEDs/each optic: 1            Light colour: White            Required components:</p>	
<p><b>CREE</b> LED</p> <p>LED: XQ-E HI            FWHM / FWTM: 166.0° / 181.0°            Efficiency: 97 %            Peak intensity: 0.6 cd/lm            LEDs/each optic: 1            Light colour: Red            Required components:</p>	

#### PHOTOMETRIC DATA (SIMULATED):

##### LUMILEDS

LED LUXEON C  
 FWHM / FWTM 175.0° / 188.0°  
 Efficiency 95 %  
 Peak intensity 0.5 cd/lm  
 LEDs/each optic 1  
 Light colour Green  
 Required components:

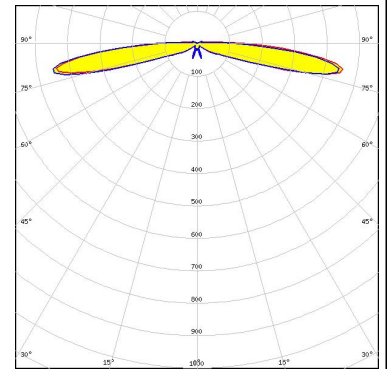

##### LUMILEDS

LED LUXEON C  
 FWHM / FWTM 177.0° / 192.0°  
 Efficiency 95 %  
 Peak intensity 0.5 cd/lm  
 LEDs/each optic 1  
 Light colour Red  
 Required components:

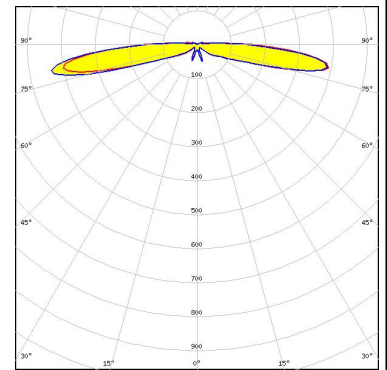

##### LUMILEDS

LED LUXEON CZ  
 FWHM / FWTM 166.0° / 178.0°  
 Efficiency 97 %  
 Peak intensity 0.7 cd/lm  
 LEDs/each optic 1  
 Light colour Blue  
 Required components:

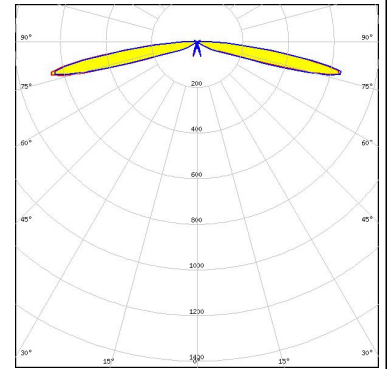

##### LUMILEDS

LED LUXEON CZ  
 FWHM / FWTM 166.0° / 178.0°  
 Efficiency 97 %  
 Peak intensity 0.7 cd/lm  
 LEDs/each optic 1  
 Light colour Royal Blue  
 Required components:

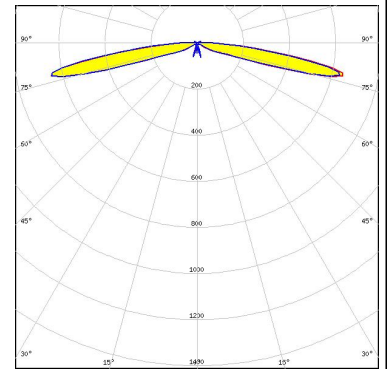



#### PHOTOMETRIC DATA (SIMULATED):

##### LUMILEDS

LED LUXEON CZ  
 FWHM / FWTM 168.0° / 179.0°  
 Efficiency 97 %  
 Peak intensity 0.6 cd/lm  
 LEDs/each optic 1  
 Light colour Red  
 Required components:

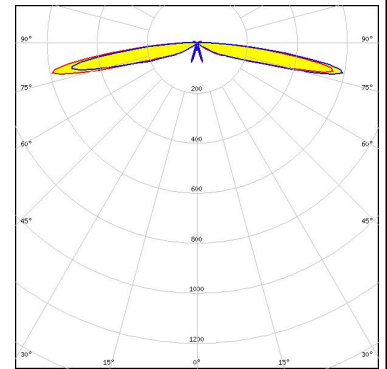

##### LUMILEDS

LED LUXEON CZ  
 FWHM / FWTM 168.0° / 179.0°  
 Efficiency 97 %  
 Peak intensity 0.6 cd/lm  
 LEDs/each optic 1  
 Light colour Amber  
 Required components:

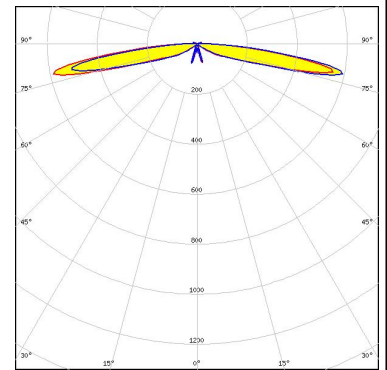

##### LUMILEDS

LED LUXEON CZ  
 FWHM / FWTM 166.0° / 178.0°  
 Efficiency 97 %  
 Peak intensity 0.7 cd/lm  
 LEDs/each optic 1  
 Light colour Green  
 Required components:

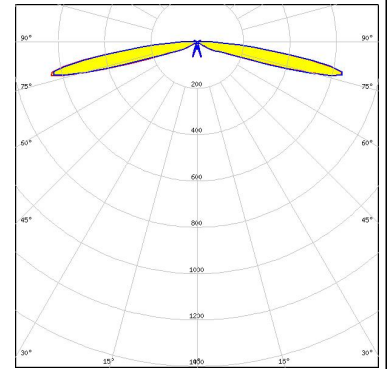

##### LUMILEDS

LED LUXEON Rubix  
 FWHM / FWTM 168.0° / 178.0°  
 Efficiency 97 %  
 Peak intensity 0.7 cd/lm  
 LEDs/each optic 1  
 Light colour Green  
 Required components:

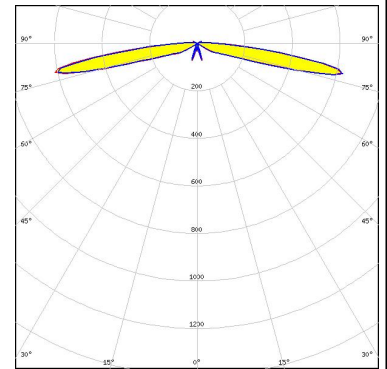

#### PHOTOMETRIC DATA (SIMULATED):

<p><b>LUMILEDS</b></p> <p>LED LUXEON V2            FWHM / FWTM 172.0° / 196.0°            Efficiency 94 %            Peak intensity 0.4 cd/lm            LEDs/each optic 1            Light colour White            Required components:</p>	
<p><b>NICHIA</b></p> <p>LED NCSxE17A            FWHM / FWTM 166.0° / 189.0°            Efficiency 94 %            Peak intensity 0.4 cd/lm            LEDs/each optic 1            Light colour Green            Required components:</p>	
<p><b>NICHIA</b></p> <p>LED NF2W757G-MT (Tunable White)            FWHM / FWTM 174.0 + 178.0° / 182.0°            Efficiency 90 %            Peak intensity 0.4 cd/lm            LEDs/each optic 1            Light colour Tunable White            Required components:</p>	
<p><b>NICHIA</b></p> <p>LED NVSxE21A            FWHM / FWTM 164.0° / 188.0°            Efficiency 96 %            Peak intensity 0.4 cd/lm            LEDs/each optic 1            Light colour White            Required components:</p>	

#### PHOTOMETRIC DATA (SIMULATED):

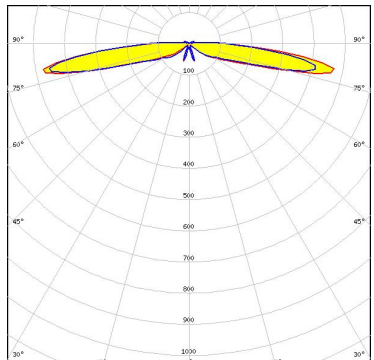
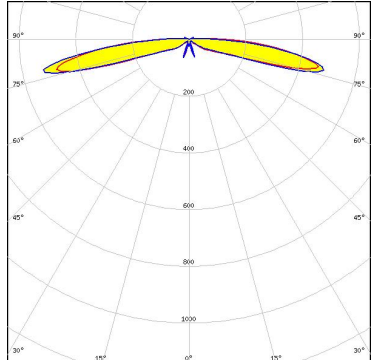
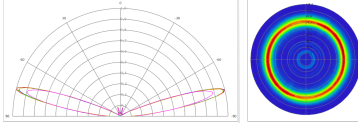
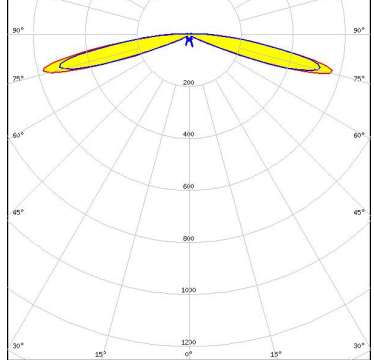
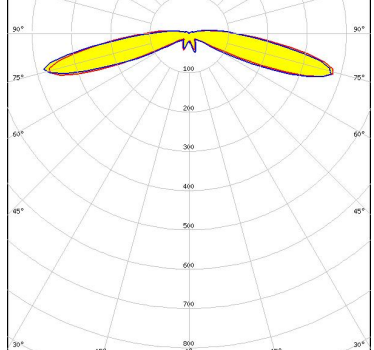
<p><b>OSRAM</b> Opto Semiconductors</p> <p>LED: OSLON Signal            FWHM / FWTM: 172.0° / 188.0°            Efficiency: 97 %            Peak intensity: 0.5 cd/lm            LEDs/each optic: 1            Light colour: Red            Required components:</p>		
<p><b>OSRAM</b> Opto Semiconductors</p> <p>LED: OSLON SSL 150            FWHM / FWTM: 171.0° / 187.0°            Efficiency: 97 %            Peak intensity: 0.5 cd/lm            LEDs/each optic: 1            Light colour: Red            Required components:</p>		
<p><b>OSRAM</b> Opto Semiconductors</p> <p>LED: SFH 4716AS            FWHM / FWTM: 164.0° / 180.0°            Efficiency: 96 %            LEDs/each optic: 1            Light colour: IR            Required components:</p>		
<p><b>SAMSUNG</b></p> <p>LED: LM28xB Series            FWHM / FWTM: 169.0° / 199.0°            Efficiency: 97 %            Peak intensity: 0.4 cd/lm            LEDs/each optic: 1            Light colour: White            Required components:</p>		

#### PHOTOMETRIC DATA (SIMULATED):

<p> SEOUL SEMICONDUCTOR</p> <p>LED MJT 3030</p> <p>FWHM / FWTM 172.0° / 194.0°</p> <p>Efficiency 95 %</p> <p>Peak intensity 0.5 cd/lm</p> <p>LEDs/each optic 1</p> <p>Light colour White</p> <p>Required components:</p>	
<p> SEOUL SEMICONDUCTOR</p> <p>LED Z8Y22P</p> <p>FWHM / FWTM 152.0°</p> <p>Efficiency 87 %</p> <p>Peak intensity 0.4 cd/lm</p> <p>LEDs/each optic 1</p> <p>Light colour White</p> <p>Required components:</p>	

### GENERAL INFORMATION:

NOTE: The typical beam angle will be changed by different color, chip size and chip position tolerance. The typical total beam angle is the full angle measured where the luminous intensity is half of the peak value.

### MATERIALS:

As part of our continuous research and improvement processes, and to ensure the best possible quality and availability of our products, LEDiL reserves the right to change material grades without notice.

### PRODUCT DATA USER AGREEMENT AND DISCLAIMER:

The measured data in the provided downloadable LEDiL Product Datasheets and Mechanical 2D-Drawings is rounded and provided as reference for planning. LEDiL Oy's optical specifications have been verified by conducting performance testing of the products in accordance with the company's quality system. The reported data are averaged results of multiple measurements with typical variation. LEDiL Oy reserves the right to without prior notification make changes and improvements to its products.

LEDiL Oy assumes neither warranty, nor guarantee nor any other liability of any kind for the contents and correctness of the provided data. The provided data has been generated with highest diligence but the provided data may in reality not represent the complete possible variation range of all intrinsic parameters. Therefore, in certain cases a deviation from the provided data could occur.

LEDiL Oy reserves the right to undertake technical changes of its products without further notification which could lead to changes in the provided data. LEDiL Oy assumes no liability of any kind for the possible deviation from any provided data or any other damage resulting from the usage of the provided data.

The user agrees to this disclaimer and user agreement with the download or usage of the provided files.

#### LEDiL Oy

Joensuunkatu 13  
FI-24240 SALO  
Finland

#### LEDiL Inc.

228 West Page Street  
Suite D  
Sycamore IL 60178  
USA

#### Ledil Optics Technology (Shenzhen) Co., Ltd.

# 405 , Block B  
Casic Motor Building  
Shenzhen 518057  
P.R.CHINA

#### Local sales and technical support

[www.ledil.com/  
where\\_to\\_buy](http://www.ledil.com/where_to_buy)

#### Shipping locations

Salo, Finland  
Hong Kong, China

#### Distribution Partners

[www.ledil.com/  
where\\_to\\_buy](http://www.ledil.com/where_to_buy)