

STRADA-SQ-A-T

Short IESNA Type II beam for narrow roads or high poles with extremely low glare. Version with location pins. Assembly with installation tape. Optimized for CREE XP-L.

TECHNICAL SPECIFICATIONS:

Dimensions	25.0 x 25.0 mm
Height	9.1 mm
Fastening	tape, pin, screw
ROHS compliant	yes ⓘ



MATERIAL SPECIFICATIONS:

Component	Type	Material	Colour	Finish
STRADA-SQ-A-T	Single lens	PMMA	clear	
ROSE-TAPE	Tape	Acrylic foam	black	

ORDERING INFORMATION:

Component	Type	Qty in box	MOQ	MPQ	Box weight (kg)
CA13119_STRADA-SQ-A-T	Single lens			98	10.1
» Box size:					

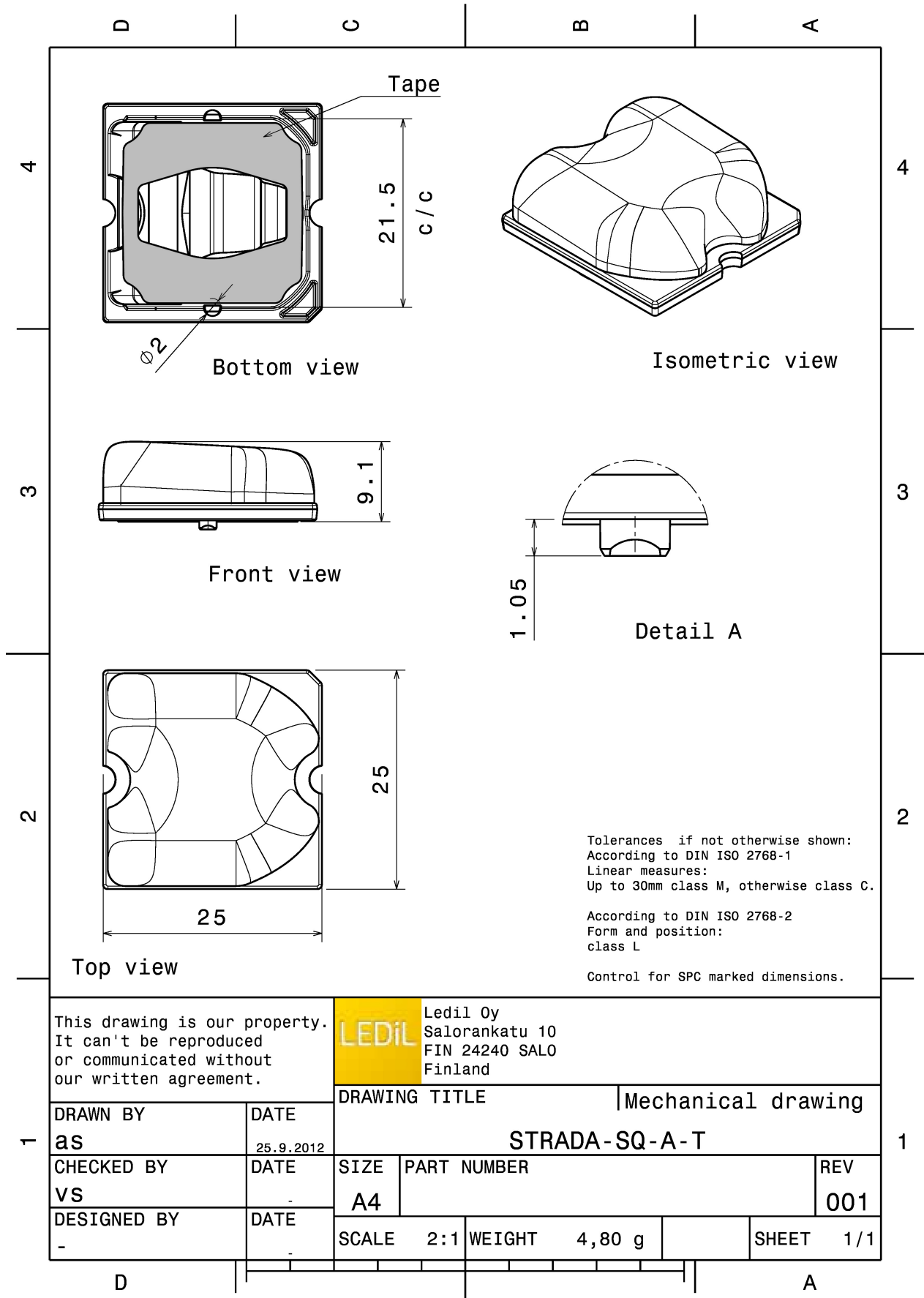

See also our general installation guide: www.ledil.com/installation_guide

PHOTOMETRIC DATA (MEASURED):

<p>CREE LED</p> <p>LED XHP50 FWHM / FWTM Asymmetric Efficiency 94 % Peak intensity 0.6 cd/lm LEDs/each optic 1 Light colour White Required components:</p>	
<p>CREE LED</p> <p>LED XM-L FWHM / FWTM Asymmetric Efficiency 93 % Peak intensity 0.3 cd/lm LEDs/each optic 1 Light colour White Required components:</p>	
<p>CREE LED</p> <p>LED XM-L2 FWHM / FWTM Asymmetric Efficiency 94 % Peak intensity 0.7 cd/lm LEDs/each optic 1 Light colour White Required components:</p>	
<p>CREE LED</p> <p>LED XP-L HD FWHM / FWTM Asymmetric Efficiency 93 % Peak intensity 0.7 cd/lm LEDs/each optic 1 Light colour White Required components:</p>	

PHOTOMETRIC DATA (MEASURED):

<p>CREE LED</p> <p>LED: XP-L2 FWHM / FWTM: Asymmetric Efficiency: 93 % Peak intensity: 0.6 cd/lm LEDs/each optic: 1 Light colour: White Required components:</p>	
<p>LUMILEDS</p> <p>LED: LUXEON M/MX FWHM / FWTM: Asymmetric Efficiency: 93 % Peak intensity: 0.3 cd/lm LEDs/each optic: 1 Light colour: White Required components:</p>	
<p>LUMILEDS</p> <p>LED: LUXEON MZ FWHM / FWTM: Asymmetric Efficiency: 93 % Peak intensity: 0.8 cd/lm LEDs/each optic: 1 Light colour: White Required components:</p>	
<p>LUMILEDS</p> <p>LED: LUXEON T FWHM / FWTM: Asymmetric Efficiency: 92 % Peak intensity: 0.9 cd/lm LEDs/each optic: 1 Light colour: White Required components:</p>	

PHOTOMETRIC DATA (MEASURED):

LUMILEDS

LED LUXEON TX
 FWHM / FWTM Asymmetric
 Efficiency 94 %
 Peak intensity 0.9 cd/lm
 LEDs/each optic 1
 Light colour White
 Required components:

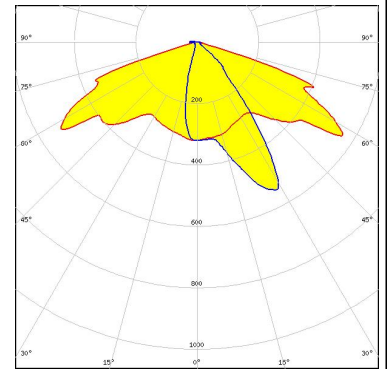

LUMILEDS

LED LUXEON XR-M linear 1x3, 1x4, 1x5
 FWHM / FWTM Asymmetric
 Efficiency 94 %
 Peak intensity 0.5 cd/lm
 LEDs/each optic 1
 Light colour White
 Required components:

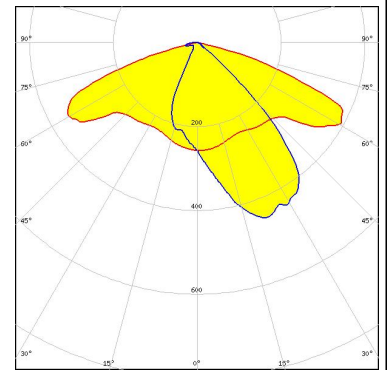

NICHIA

LED NS9x383
 FWHM / FWTM Asymmetric
 Efficiency 92 %
 Peak intensity 0.7 cd/lm
 LEDs/each optic 1
 Light colour White
 Required components:

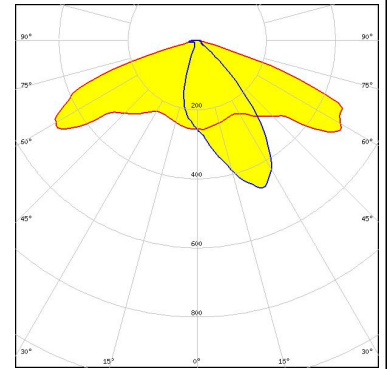

NICHIA

LED NV4x144A
 FWHM / FWTM Asymmetric
 Efficiency 93 %
 Peak intensity 0.6 cd/lm
 LEDs/each optic 1
 Light colour White
 Required components:

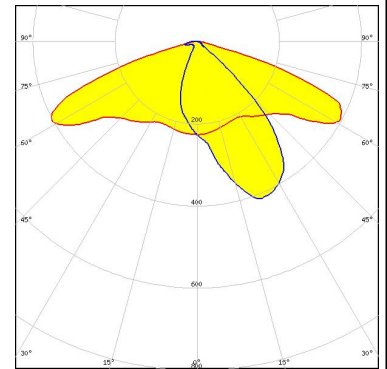

PHOTOMETRIC DATA (MEASURED):



LED NVSW319B
FWHM / FWTM Asymmetric
Efficiency 94 %
Peak intensity 1.3 cd/lm
LEDs/each optic 1
Light colour White
Required components:

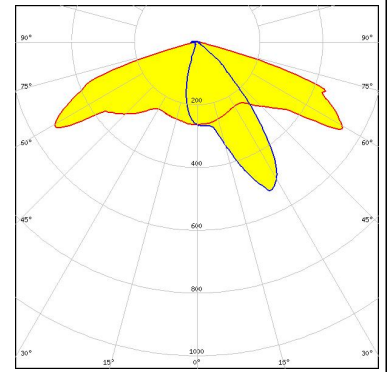

LED Duris S10
FWHM / FWTM Asymmetric
Efficiency 93 %
Peak intensity 0.6 cd/lm
LEDs/each optic 1
Light colour White
Required components:

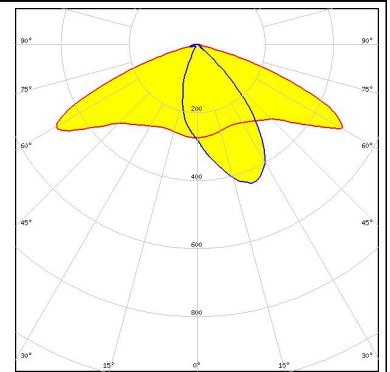

PHOTOMETRIC DATA (SIMULATED):

<p>NICHIA</p> <p>LED: NVSxx19B/NVSxx19C FWHM / FWTM: Asymmetric Efficiency: 90 % LEDs/each optic: 1 Light colour: White Required components:</p>	
<p>OSRAM <small>Opto Semiconductors</small></p> <p>LED: OSCONIQ C 2424 FWHM / FWTM: Asymmetric Efficiency: 93 % Peak intensity: 0.6 cd/lm LEDs/each optic: 4 Light colour: White Required components:</p>	

GENERAL INFORMATION:

NOTE: The typical beam angle will be changed by different color, chip size and chip position tolerance. The typical total beam angle is the full angle measured where the luminous intensity is half of the peak value.

MATERIALS:

As part of our continuous research and improvement processes, and to ensure the best possible quality and availability of our products, LEDiL reserves the right to change material grades without notice.

PRODUCT DATA USER AGREEMENT AND DISCLAIMER:

The measured data in the provided downloadable LEDiL Product Datasheets and Mechanical 2D-Drawings is rounded and provided as reference for planning. LEDiL Oy's optical specifications have been verified by conducting performance testing of the products in accordance with the company's quality system. The reported data are averaged results of multiple measurements with typical variation. LEDiL Oy reserves the right to without prior notification make changes and improvements to its products.

LEDiL Oy assumes neither warranty, nor guarantee nor any other liability of any kind for the contents and correctness of the provided data. The provided data has been generated with highest diligence but the provided data may in reality not represent the complete possible variation range of all intrinsic parameters. Therefore, in certain cases a deviation from the provided data could occur.

LEDiL Oy reserves the right to undertake technical changes of its products without further notification which could lead to changes in the provided data. LEDiL Oy assumes no liability of any kind for the possible deviation from any provided data or any other damage resulting from the usage of the provided data.

The user agrees to this disclaimer and user agreement with the download or usage of the provided files.

LEDiL Oy

Joensuunkatu 13
FI-24240 SALO
Finland

LEDiL Inc.

228 West Page Street
Suite D
Sycamore IL 60178
USA

Ledil Optics Technology (Shenzhen) Co., Ltd.

405 , Block B
Casic Motor Building
Shenzhen 518057
P.R.CHINA

Local sales and technical support

[www.ledil.com/
where_to_buy](http://www.ledil.com/where_to_buy)

Shipping locations

Salo, Finland
Hong Kong, China

Distribution Partners

[www.ledil.com/
where_to_buy](http://www.ledil.com/where_to_buy)