

## STRADA-SQ-FT

Forward throw beam for area lighting. Assembly with installation tape. Version with location pins.

### TECHNICAL SPECIFICATIONS:

Dimensions	25.0 x 25.0 mm
Height	12.7 mm
Fastening	pin, screw, tape
ROHS compliant	yes ⓘ

### MATERIAL SPECIFICATIONS:

Component	Type	Material	Colour	Finish
STRADA-SQ-FT	Single lens	PMMA	clear	
ROSE-TAPE	Tape	Acrylic foam	black	

### ORDERING INFORMATION:

Component		Qty in box	MOQ	MPQ	Box weight (kg)
CA13752_STRADA-SQ-FT	Single lens	1568	294	98	7.2
» Box size: 480 x 280 x 300 mm					



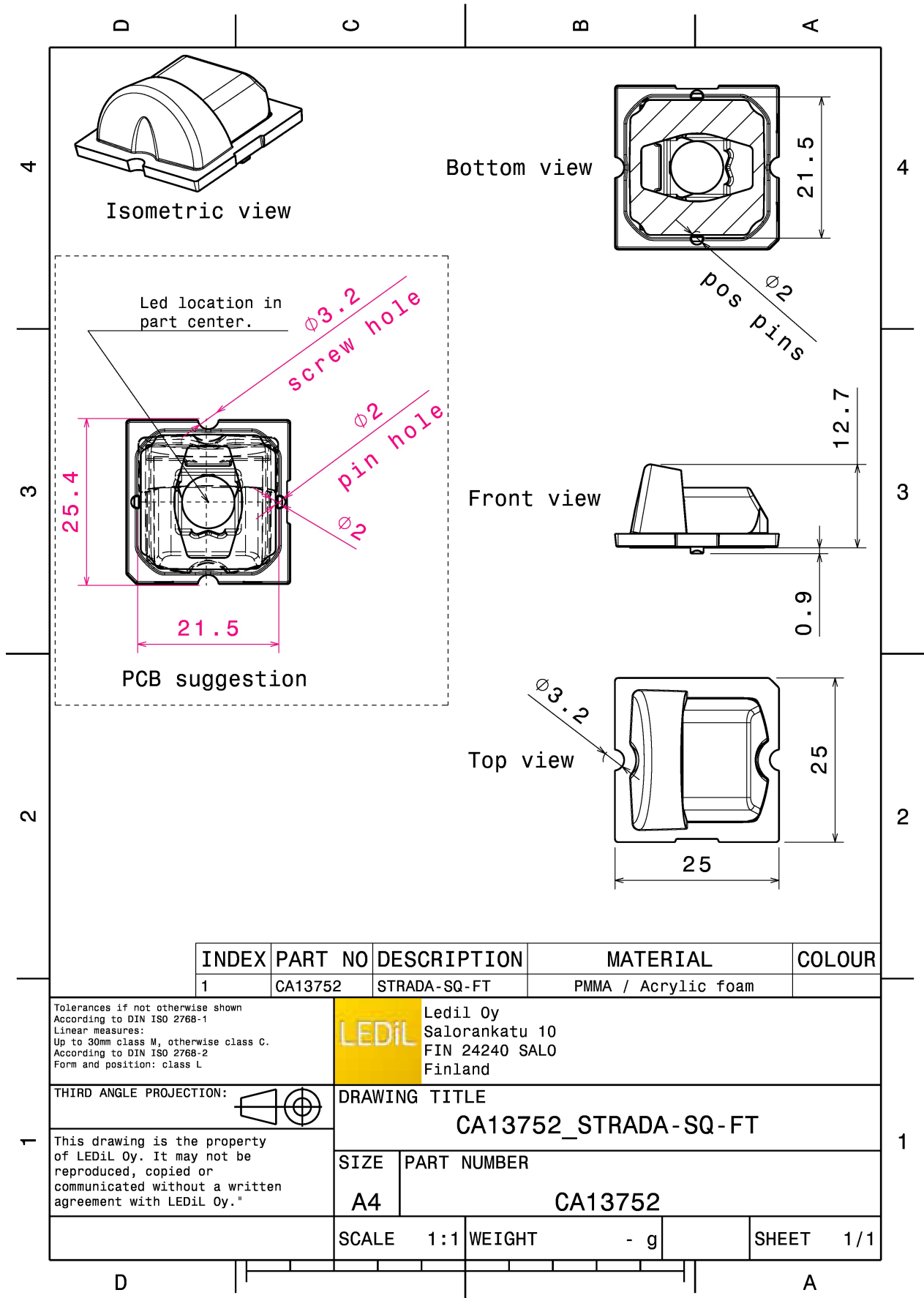

INDEX	PART NO	DESCRIPTION	MATERIAL	COLOUR
1	CA13752	STRADA-SQ-FT	PMMA / Acrylic foam	

Tolerances if not otherwise shown  
According to DIN ISO 2768-1  
Linear measures:  
Up to 30mm class M, otherwise class C.  
According to DIN ISO 2768-2  
Form and position: class L



Ledil Oy  
Salorankatu 10  
FIN 24240 SALO  
Finland

THIRD ANGLE PROJECTION:

DRAWING TITLE  
CA13752\_STRADA-SQ-FT

This drawing is the property of LEDiL Oy. It may not be reproduced, copied or communicated without a written agreement with LEDiL Oy."

SIZE	PART NUMBER
A4	CA13752

SCALE	1:1	WEIGHT	- g	SHEET	1/1
-------	-----	--------	-----	-------	-----

See also our general installation guide: [www.ledil.com/installation\\_guide](http://www.ledil.com/installation_guide)

#### PHOTOMETRIC DATA (MEASURED):

##### CREE LED

LED MK-R  
 FWHM / FWTM Asymmetric  
 Efficiency 89 %  
 Peak intensity 0.6 cd/lm  
 LEDs/each optic 1  
 Light colour White  
 Required components:

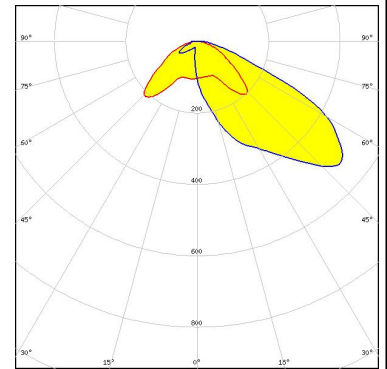

##### CREE LED

LED XHP50  
 FWHM / FWTM Asymmetric  
 Efficiency 90 %  
 Peak intensity 0.6 cd/lm  
 LEDs/each optic 1  
 Light colour White  
 Required components:

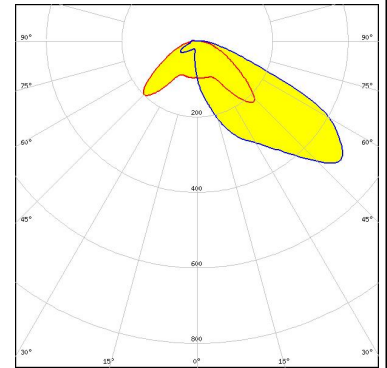

##### CREE LED

LED XM-L  
 FWHM / FWTM Asymmetric  
 Efficiency 90 %  
 Peak intensity 0.7 cd/lm  
 LEDs/each optic 1  
 Light colour White  
 Required components:

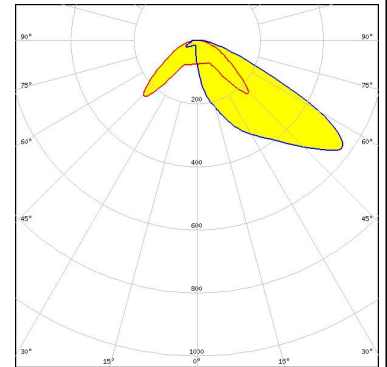

##### CREE LED

LED XP-L HD  
 FWHM / FWTM Asymmetric  
 Efficiency 91 %  
 Peak intensity 0.7 cd/lm  
 LEDs/each optic 1  
 Light colour White  
 Required components:

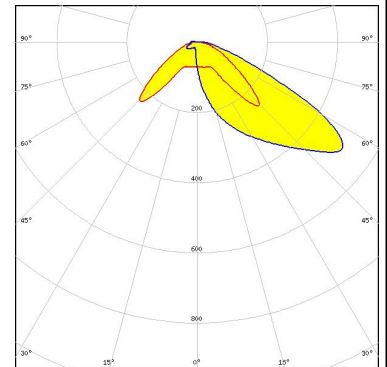

#### PHOTOMETRIC DATA (MEASURED):

<p><b>CREE</b> LED</p> <p>LED: XP-L2            FWHM / FWTM: Asymmetric            Efficiency: 90 %            Peak intensity: 0.7 cd/lm            LEDs/each optic: 1            Light colour: White            Required components:</p>	
<p><b>LUMILEDS</b></p> <p>LED: LUXEON M/MX            FWHM / FWTM: Asymmetric            Efficiency: 88 %            Peak intensity: 0.6 cd/lm            LEDs/each optic: 1            Light colour: White            Required components:</p>	
<p><b>LUMILEDS</b></p> <p>LED: LUXEON MZ            FWHM / FWTM: Asymmetric            Efficiency: 90 %            Peak intensity: 0.7 cd/lm            LEDs/each optic: 1            Light colour: White            Required components:</p>	
<p><b>LUMILEDS</b></p> <p>LED: LUXEON XR-M linear 1x3, 1x4, 1x5            FWHM / FWTM: Asymmetric            Efficiency: 92 %            Peak intensity: 0.7 cd/lm            LEDs/each optic: 1            Light colour: White            Required components:</p>	







### PHOTOMETRIC DATA (MEASURED):

		
LED	NVSW319B	
FWHM / FWTM	Asymmetric	
Efficiency	90 %	
Peak intensity	0.7 cd/lm	
LEDs/each optic	1	
Light colour	White	
Required components:		
		
		
LED	Duris S10	
FWHM / FWTM	Asymmetric	
Efficiency	89 %	
Peak intensity	0.6 cd/lm	
LEDs/each optic	1	
Light colour	White	
Required components:		
		

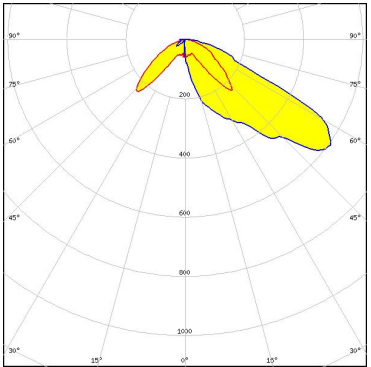
### PHOTOMETRIC DATA (SIMULATED):

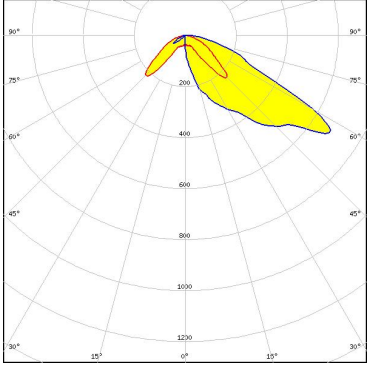
<p><b>CREE</b> ⇄ <b>LED</b></p> <p>LED: MX-3            FWHM / FWTM: Asymmetric            Efficiency: 90 %            LEDs/each optic: 1            Light colour: White            Required components:</p>	
<p><b>CREE</b> ⇄ <b>LED</b></p> <p>LED: MX-6            FWHM / FWTM: Asymmetric            Efficiency: 90 %            LEDs/each optic: 1            Light colour: White            Required components:</p>	
<p><b>CREE</b> ⇄ <b>LED</b></p> <p>LED: XHP50.3 HD            FWHM / FWTM: Asymmetric            Efficiency: 90 %            Peak intensity: 0.7 cd/lm            LEDs/each optic: 1            Light colour: White            Required components:</p>	
<p><b>CREE</b> ⇄ <b>LED</b></p> <p>LED: XHP50.3 HI            FWHM / FWTM: Asymmetric            Efficiency: 92 %            Peak intensity: 0.7 cd/lm            LEDs/each optic: 1            Light colour: White            Required components:</p>	

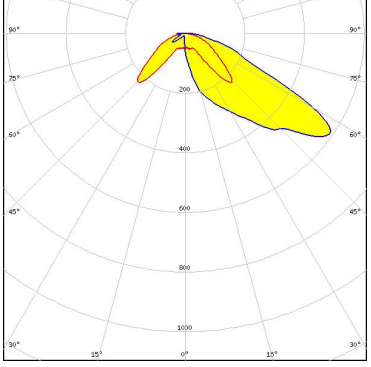
### PHOTOMETRIC DATA (SIMULATED):

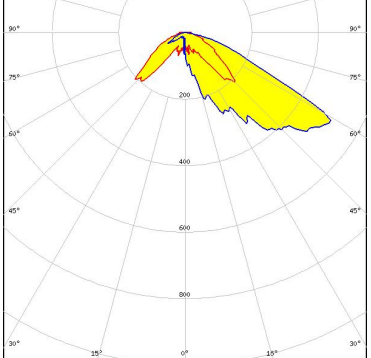
	<p>LED XM-L2            FWHM / FWTM Asymmetric            Efficiency 90 %            LEDs/each optic 1            Light colour White            Required components:</p>	
	<p>LED XP-G2            FWHM / FWTM Asymmetric            Efficiency 89 %            LEDs/each optic 1            Light colour White            Required components:</p>	
	<p>LED XP-G3            FWHM / FWTM Asymmetric            Efficiency 91 %            Peak intensity 0.8 cd/lm            LEDs/each optic 1            Light colour Red            Required components:</p>	
	<p>LED XP-G3            FWHM / FWTM Asymmetric            Efficiency 76 %            Peak intensity 0.7 cd/lm            LEDs/each optic 1            Light colour White            Required components:</p>	

Protective plate, glass

### PHOTOMETRIC DATA (SIMULATED):

#### CREE LED

LED XP-L2  
 FWHM / FWTM Asymmetric  
 Efficiency 76 %  
 Peak intensity 0.6 cd/lm  
 LEDs/each optic 1  
 Light colour White  
 Required components:

Protective plate, glass

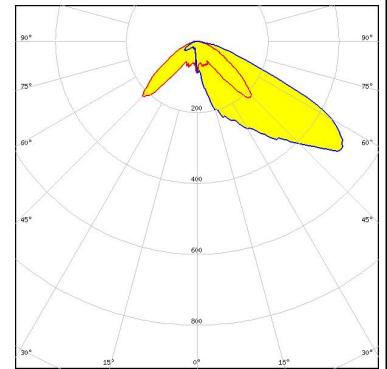

#### CREE LED

LED XT-E  
 FWHM / FWTM Asymmetric  
 Efficiency 93 %  
 Peak intensity 0.6 cd/lm  
 LEDs/each optic 1  
 Light colour White  
 Required components:

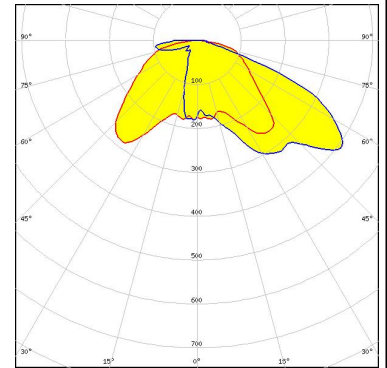

#### LUMILEDS

LED LUXEON M/MX  
 FWHM / FWTM Asymmetric  
 Efficiency 78 %  
 Peak intensity 0.6 cd/lm  
 LEDs/each optic 1  
 Light colour White  
 Required components:

Protective plate, glass

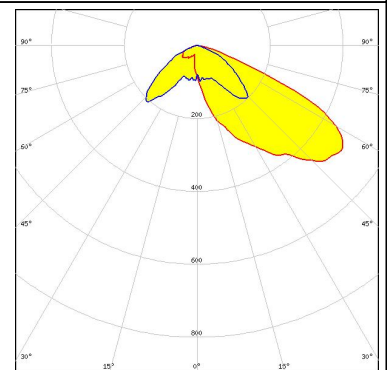

#### LUMINUS

LED SFT-40-WCS  
 FWHM / FWTM Asymmetric  
 Efficiency 78 %  
 Peak intensity 0.7 cd/lm  
 LEDs/each optic 1  
 Light colour White  
 Required components:

Protective plate, glass

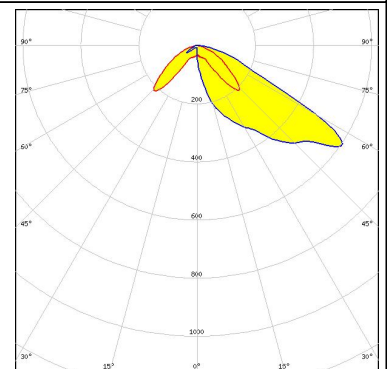

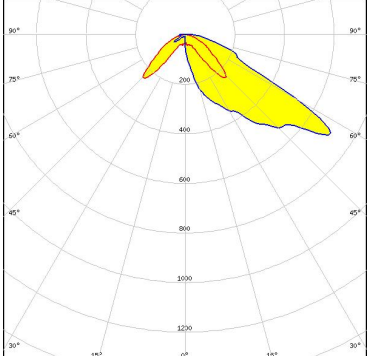
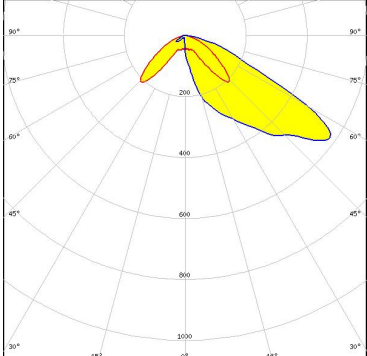
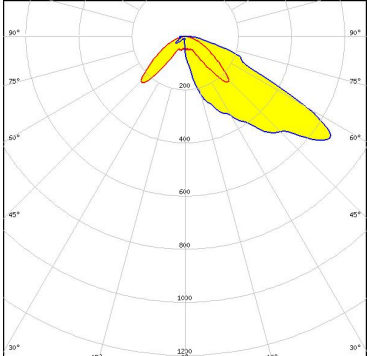
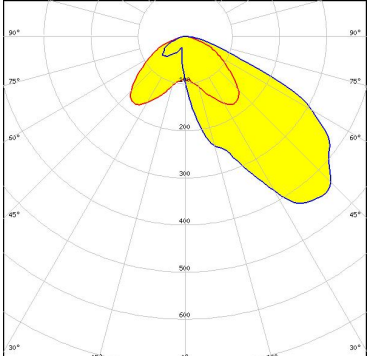

#### PHOTOMETRIC DATA (SIMULATED):

<p><b>LUMINUS</b></p> <p>LED SFT-40-WCS            FWHM / FWTM Asymmetric            Efficiency 93 %            Peak intensity 0.9 cd/lm            LEDs/each optic 1            Light colour White            Required components:</p>	
<p><b>LUMINUS</b></p> <p>LED SFT-70X-WCS            FWHM / FWTM Asymmetric            Efficiency 78 %            Peak intensity 0.7 cd/lm            LEDs/each optic 1            Light colour White            Required components:</p> <p style="background-color: #ADD8E6; padding: 2px; display: inline-block;">Protective plate, glass</p>	
<p><b>LUMINUS</b></p> <p>LED SFT-70X-WCS            FWHM / FWTM Asymmetric            Efficiency 93 %            Peak intensity 0.8 cd/lm            LEDs/each optic 1            Light colour White            Required components:</p>	
<p><b>NICHIA</b></p> <p>LED NVSxE21A            FWHM / FWTM Asymmetric            Efficiency 78 %            Peak intensity 0.5 cd/lm            LEDs/each optic 9            Light colour White            Required components:</p> <p style="background-color: #ADD8E6; padding: 2px; display: inline-block;">Protective plate, glass</p>	

### PHOTOMETRIC DATA (SIMULATED):

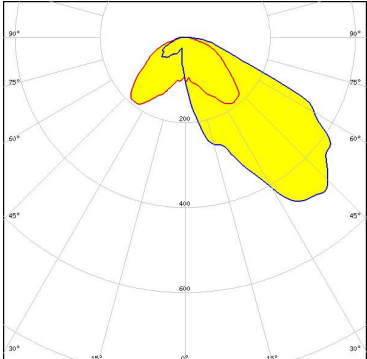
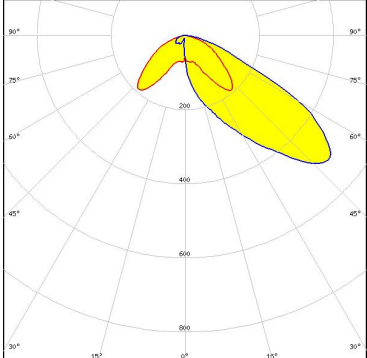
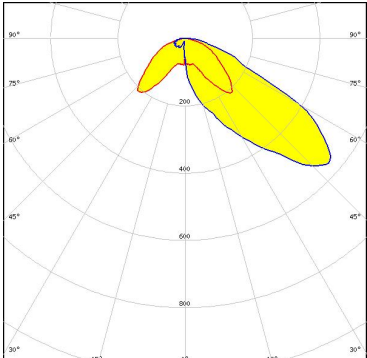
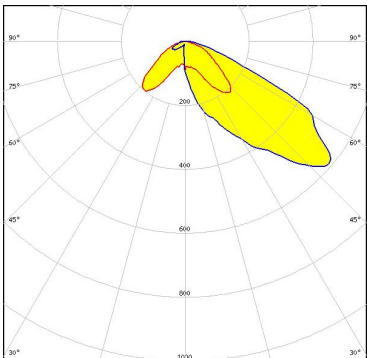
<p><b>NICHIA</b></p> <p>LED: NVSxE21A            FWHM / FWTM: Asymmetric            Efficiency: 91 %            Peak intensity: 0.6 cd/lm            LEDs/each optic: 9            Light colour: White            Required components:</p>	
<p><b>NICHIA</b></p> <p>LED: NVSxE21A            FWHM / FWTM: Asymmetric            Efficiency: 78 %            Peak intensity: 0.6 cd/lm            LEDs/each optic: 4            Light colour: White            Required components:</p> <p style="background-color: #ADD8E6; padding: 2px; display: inline-block;">Protective plate, glass</p>	
<p><b>NICHIA</b></p> <p>LED: NVSxE21A            FWHM / FWTM: Asymmetric            Efficiency: 93 %            Peak intensity: 0.7 cd/lm            LEDs/each optic: 4            Light colour: White            Required components:</p>	
<p><b>OSRAM</b>  <small>Opto Semiconductors</small></p> <p>LED: OSCONIQ C 2424            FWHM / FWTM: Asymmetric            Efficiency: 92 %            Peak intensity: 0.7 cd/lm            LEDs/each optic: 4            Light colour: White            Required components:</p>	

#### PHOTOMETRIC DATA (SIMULATED):

#### OSRAM

Opto Semiconductors

LED OSCONIQ P 7070  
 FWHM / FWTM Asymmetric  
 Efficiency 89 %  
 Peak intensity 0.8 cd/lm  
 LEDs/each optic 1  
 Light colour White  
 Required components:

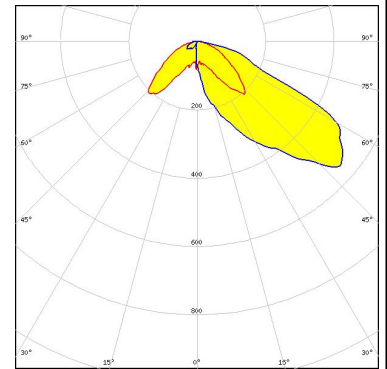

#### OSRAM

Opto Semiconductors

LED SFH 4716AS  
 FWHM / FWTM Asymmetric  
 Efficiency 92 %  
 LEDs/each optic 1  
 Light colour IR  
 Required components:

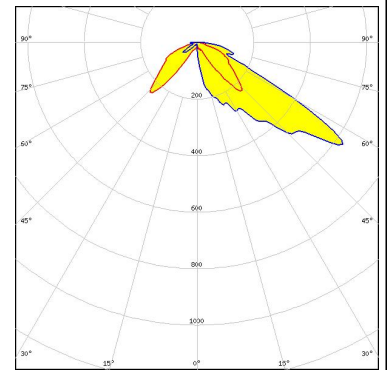

#### SAMSUNG

LED LH181B  
 FWHM / FWTM Asymmetric  
 Efficiency 92 %  
 Peak intensity 0.7 cd/lm  
 LEDs/each optic 4  
 Light colour White  
 Required components:

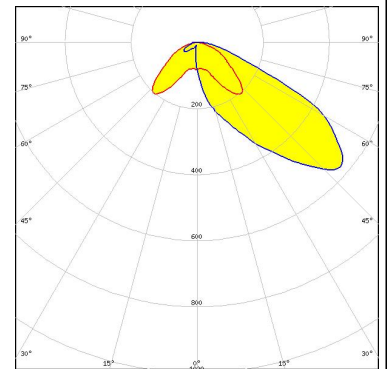

### GENERAL INFORMATION:

NOTE: The typical beam angle will be changed by different color, chip size and chip position tolerance. The typical total beam angle is the full angle measured where the luminous intensity is half of the peak value.

### MATERIALS:

As part of our continuous research and improvement processes, and to ensure the best possible quality and availability of our products, LEDiL reserves the right to change material grades without notice.

### PRODUCT DATA USER AGREEMENT AND DISCLAIMER:

The measured data in the provided downloadable LEDiL Product Datasheets and Mechanical 2D-Drawings is rounded and provided as reference for planning. LEDiL Oy's optical specifications have been verified by conducting performance testing of the products in accordance with the company's quality system. The reported data are averaged results of multiple measurements with typical variation. LEDiL Oy reserves the right to without prior notification make changes and improvements to its products.

LEDiL Oy assumes neither warranty, nor guarantee nor any other liability of any kind for the contents and correctness of the provided data. The provided data has been generated with highest diligence but the provided data may in reality not represent the complete possible variation range of all intrinsic parameters. Therefore, in certain cases a deviation from the provided data could occur.

LEDiL Oy reserves the right to undertake technical changes of its products without further notification which could lead to changes in the provided data. LEDiL Oy assumes no liability of any kind for the possible deviation from any provided data or any other damage resulting from the usage of the provided data.

The user agrees to this disclaimer and user agreement with the download or usage of the provided files.

#### LEDiL Oy

Joensuunkatu 13  
FI-24240 SALO  
Finland

#### LEDiL Inc.

228 West Page Street  
Suite D  
Sycamore IL 60178  
USA

#### Ledil Optics Technology (Shenzhen) Co., Ltd.

# 405 , Block B  
Casic Motor Building  
Shenzhen 518057  
P.R.CHINA

#### Local sales and technical support

[www.ledil.com/  
where\\_to\\_buy](http://www.ledil.com/where_to_buy)

#### Shipping locations

Salo, Finland  
Hong Kong, China

#### Distribution Partners

[www.ledil.com/  
where\\_to\\_buy](http://www.ledil.com/where_to_buy)