

FLARE-MINI-A

~100° x 20° oval beam. Assembly with installation tape.

TECHNICAL SPECIFICATIONS:

Dimensions	Ø 16.0 mm
Height	9.1 mm
Fastening	tape
ROHS compliant	yes ⓘ

MATERIAL SPECIFICATIONS:

Component	Type	Material	Colour	Finish
FLARE-MINI-A	Single lens	PMMA	clear	
TINA-TAPE3	Tape	Acrylic foam	black	

ORDERING INFORMATION:



Component		Qty in box	MOQ	MPQ	Box weight (kg)
CA12764_FLARE-MINI-A	Single lens	4600	230	230	6.7
» Box size:					

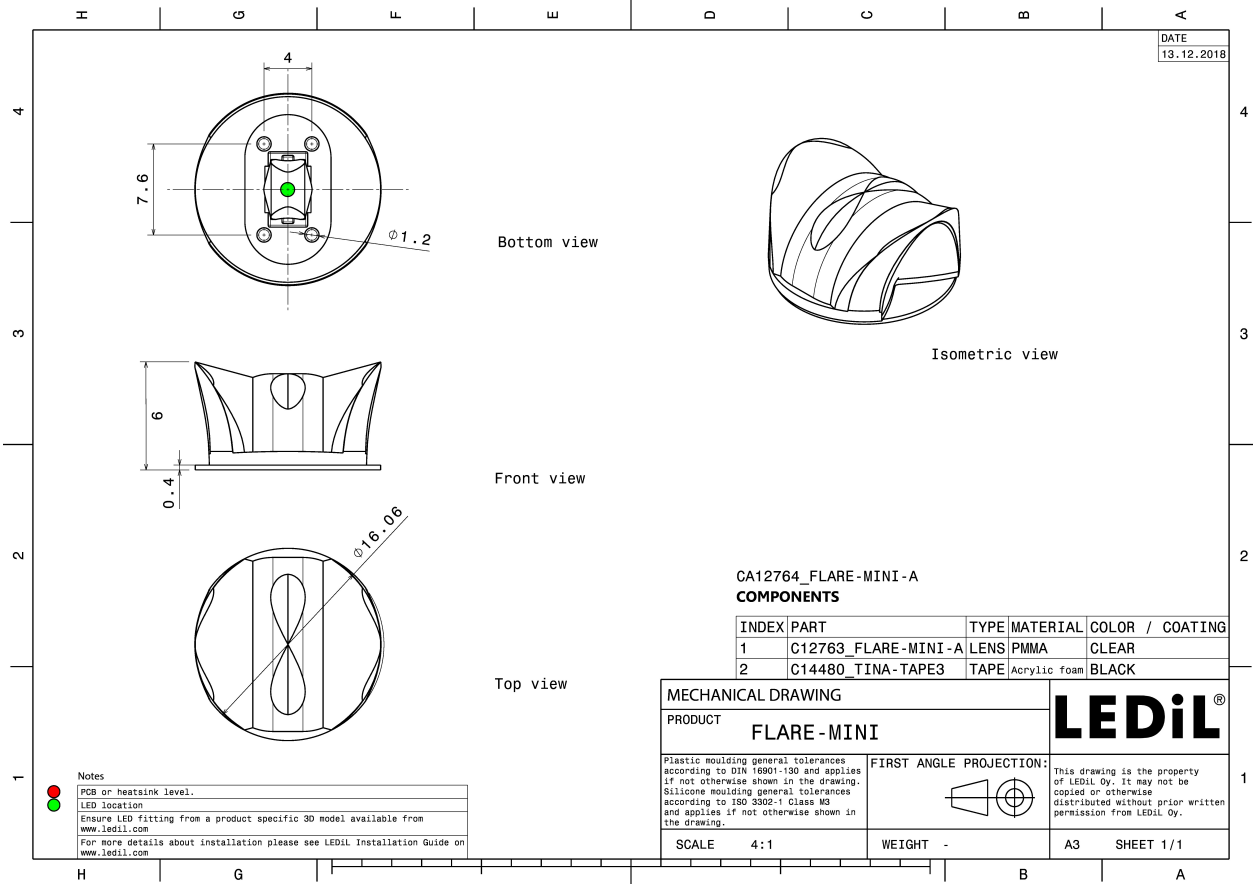

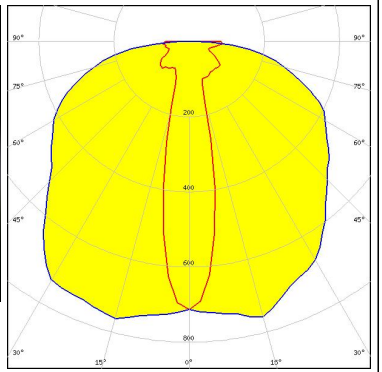
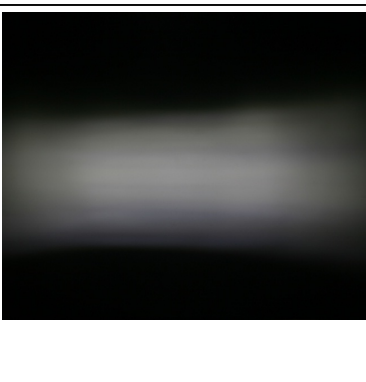
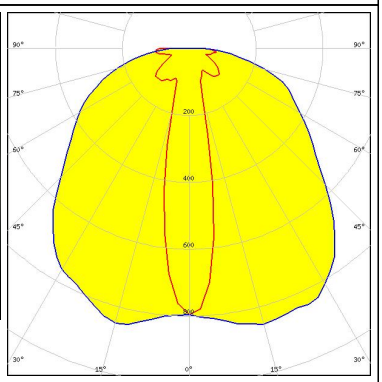

See also our general installation guide: www.ledil.com/installation_guide

PHOTOMETRIC DATA (MEASURED):

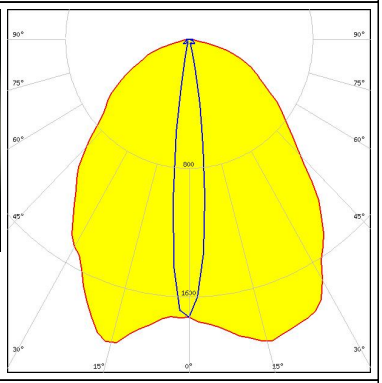
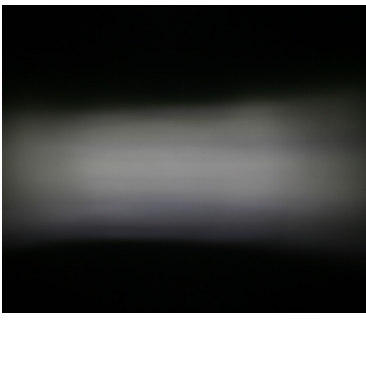
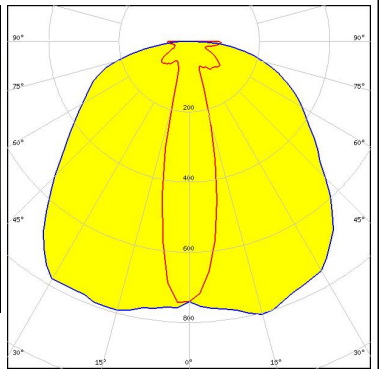
<p>CREE ⇄ LED</p> <p>LED XB-D FWHM / FWTM 130.0 + 21.0° / 119.0 + 172.0° Efficiency 94 % Peak intensity 0.8 cd/lm LEDs/each optic 1 Light colour White Required components:</p>		
<p>CREE ⇄ LED</p> <p>LED XP-E FWHM / FWTM 113.0 + 20.0° / 171.0 + 22.0° Efficiency 94 % Peak intensity 0.9 cd/lm LEDs/each optic 1 Light colour White Required components:</p>		
<p>CREE ⇄ LED</p> <p>LED XP-E2 FWHM / FWTM 92.0 + 12.0° / 152.0 + 24.0° Efficiency 94 % Peak intensity 2 cd/lm LEDs/each optic 1 Light colour White Required components:</p>		
<p>CREE ⇄ LED</p> <p>LED XP-G FWHM / FWTM 114.0 + 22.0° / 120.0 + 158.0° Efficiency 94 % Peak intensity 0.8 cd/lm LEDs/each optic 1 Light colour White Required components:</p>		

PHOTOMETRIC DATA (MEASURED):

CREE LED

LED XP-G2
 FWHM / FWTM 94.0 + 19.0° / 152.0 + 31.0°
 Efficiency 94 %
 Peak intensity 1.3 cd/lm
 LEDs/each optic 1
 Light colour White
 Required components:

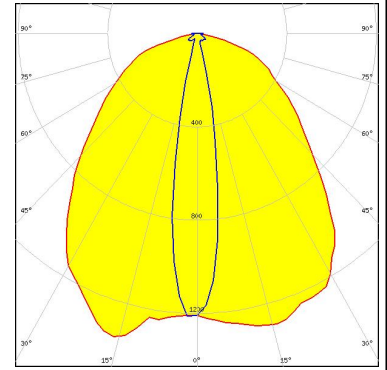

CREE LED

LED XP-L HD
 FWHM / FWTM 114.0 + 25.0° / 152.0 + 43.0°
 Efficiency 91 %
 Peak intensity 0.8 cd/lm
 LEDs/each optic 1
 Light colour White
 Required components:

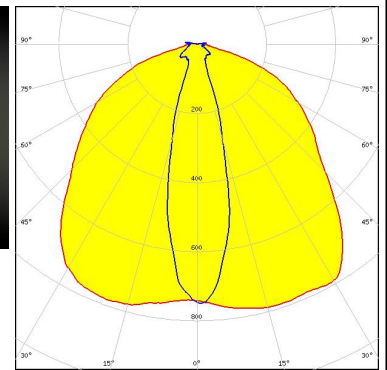
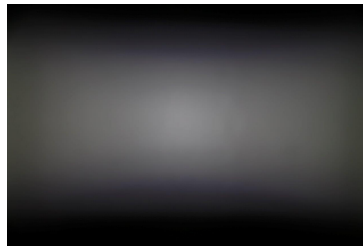

CREE LED

LED XP-L2
 FWHM / FWTM 100.0 + 28.0° / 153.0 + 49.0°
 Efficiency 94 %
 Peak intensity 0.8 cd/lm
 LEDs/each optic 1
 Light colour White
 Required components:

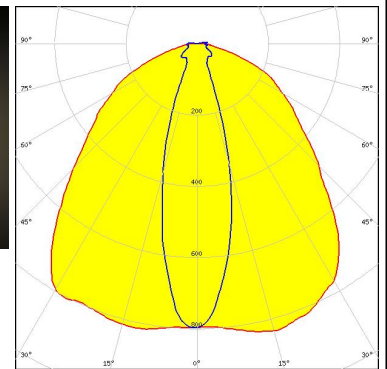
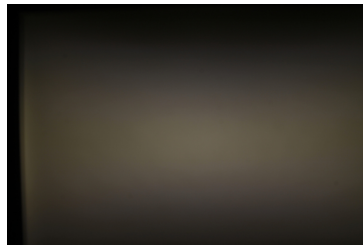



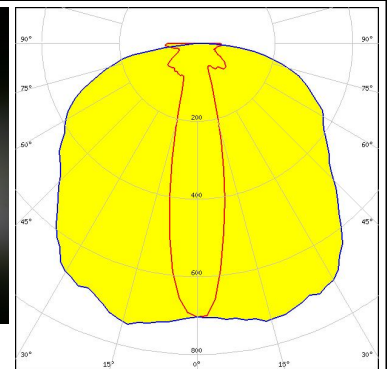
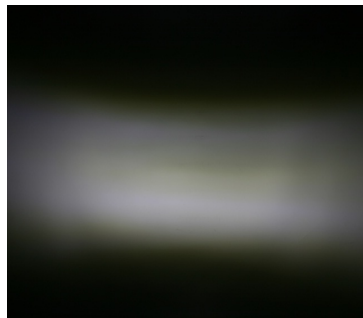

CREE LED

LED XT-E
 FWHM / FWTM 124.0 + 22.0° / 119.0 + 173.0°
 Efficiency 94 %
 Peak intensity 0.7 cd/lm
 LEDs/each optic 1
 Light colour White
 Required components:

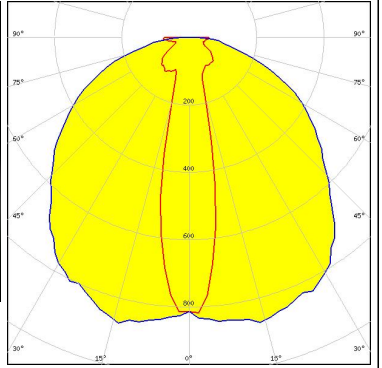

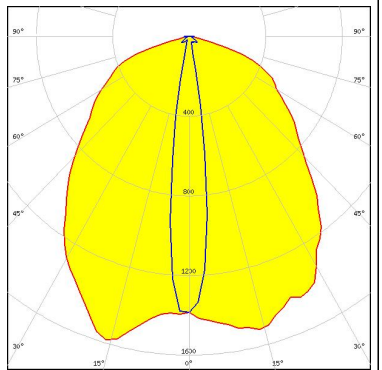
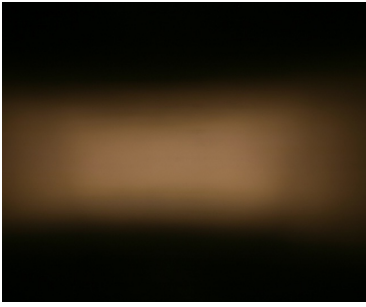
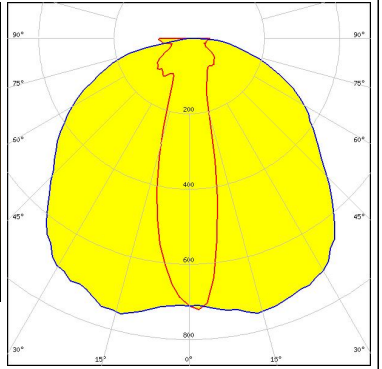
PHOTOMETRIC DATA (MEASURED):

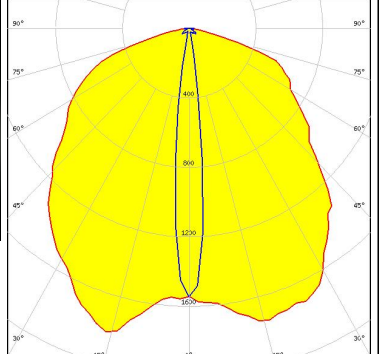
<p>NICHIA</p> <p>LED NCSxx19A FWHM / FWTM 112.0 + 20.0° / 104.0 + 167.0° Efficiency 94 % Peak intensity 0.9 cd/lm LEDs/each optic 1 Light colour White Required components:</p>		
<p>NICHIA</p> <p>LED NCSxx19B FWHM / FWTM 95.0 + 15.0° / 151.0 + 27.0° Efficiency 94 % Peak intensity 1.6 cd/lm LEDs/each optic 1 Light colour White Required components:</p>		
<p>OSRAM Opto Semiconductors</p> <p>LED OSLON Square PC FWHM / FWTM 116.0 + 22.0° / 114.0 + 172.0° Efficiency 94 % Peak intensity 0.8 cd/lm LEDs/each optic 1 Light colour White Required components:</p>		
<p>OSRAM Opto Semiconductors</p> <p>LED OSLON SSL 150 FWHM / FWTM 106.0 + 11.0° / 22.0 + 152.0° Efficiency 93 % Peak intensity 1.7 cd/lm LEDs/each optic 1 Light colour White Required components:</p>		

PHOTOMETRIC DATA (MEASURED):

OSRAM

Opto Semiconductors

LED OSLON SSL 80
 FWHM / FWTM 84.0 + 12.0° / 23.0 + 144.0°
 Efficiency 93 %
 Peak intensity 2 cd/lm
 LEDs/each optic 1
 Light colour White
 Required components:

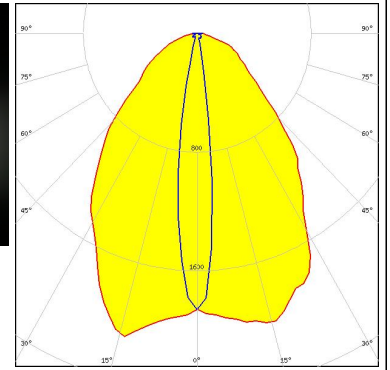

SAMSUNG

LED LH351Z
 FWHM / FWTM 95.0 + 19.0° / 133.0 + 31.0°
 Efficiency 94 %
 Peak intensity 1.5 cd/lm
 LEDs/each optic 1
 Light colour White
 Required components:

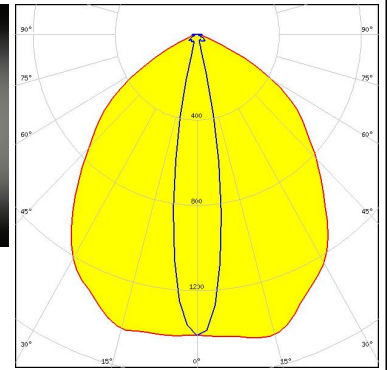
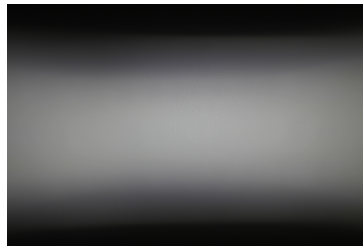

SEMI

SEOUL SEMICONDUCTOR

LED Z8Y22P
 FWHM / FWTM 115.0 + 21.0° / 154.0 + 34.0°
 Efficiency 94 %
 Peak intensity 1 cd/lm
 LEDs/each optic 1
 Light colour White
 Required components:

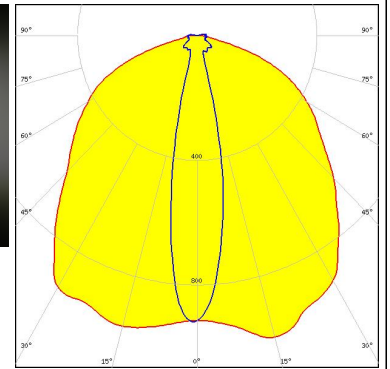

PHOTOMETRIC DATA (SIMULATED):



LED XHP35 HD
 FWHM / FWTM 31.0 + 96.0° / 51.0 + 146.0°
 Efficiency 93 %
 Peak intensity 0.9 cd/lm
 LEDs/each optic 1
 Light colour White
 Required components:

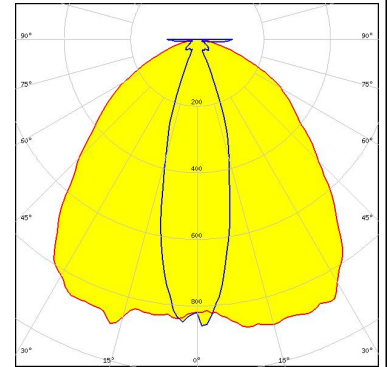

LED XHP35 HI
 FWHM / FWTM 20.0 + 92.0° / 34.0 + 146.0°
 Efficiency 94 %
 Peak intensity 1.3 cd/lm
 LEDs/each optic 1
 Light colour White
 Required components:

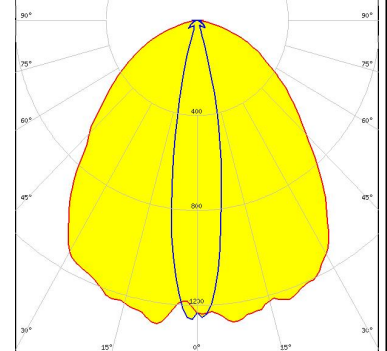

LED LUXEON C
 FWHM / FWTM 11.0 + 84.0° / 21.0 + 168.0°
 Efficiency 92 %
 Peak intensity 1.6 cd/lm
 LEDs/each optic 1
 Light colour White
 Required components:

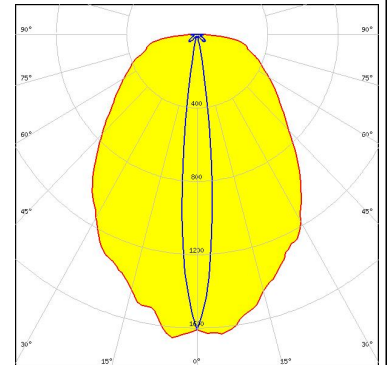

LED Z5M1/Z5M2
 FWHM / FWTM 91.0 + 19.0° / 141.0 + 29.0°
 Efficiency 95 %
 Peak intensity 1.4 cd/lm
 LEDs/each optic 1
 Light colour White
 Required components:

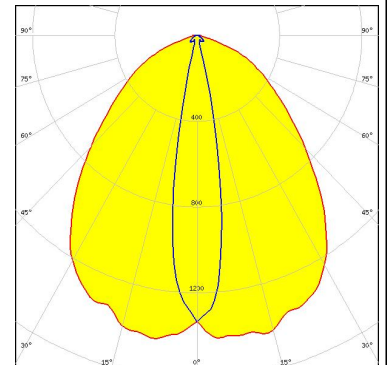

GENERAL INFORMATION:

NOTE: The typical beam angle will be changed by different color, chip size and chip position tolerance. The typical total beam angle is the full angle measured where the luminous intensity is half of the peak value.

MATERIALS:

As part of our continuous research and improvement processes, and to ensure the best possible quality and availability of our products, LEDiL reserves the right to change material grades without notice.

PRODUCT DATA USER AGREEMENT AND DISCLAIMER:

The measured data in the provided downloadable LEDiL Product Datasheets and Mechanical 2D-Drawings is rounded and provided as reference for planning. LEDiL Oy's optical specifications have been verified by conducting performance testing of the products in accordance with the company's quality system. The reported data are averaged results of multiple measurements with typical variation. LEDiL Oy reserves the right to without prior notification make changes and improvements to its products.

LEDiL Oy assumes neither warranty, nor guarantee nor any other liability of any kind for the contents and correctness of the provided data. The provided data has been generated with highest diligence but the provided data may in reality not represent the complete possible variation range of all intrinsic parameters. Therefore, in certain cases a deviation from the provided data could occur.

LEDiL Oy reserves the right to undertake technical changes of its products without further notification which could lead to changes in the provided data. LEDiL Oy assumes no liability of any kind for the possible deviation from any provided data or any other damage resulting from the usage of the provided data.

The user agrees to this disclaimer and user agreement with the download or usage of the provided files.

LEDiL Oy

Joensuunkatu 13
FI-24240 SALO
Finland

LEDiL Inc.

228 West Page Street
Suite D
Sycamore IL 60178
USA

Ledil Optics Technology (Shenzhen) Co., Ltd.

405 , Block B
Casic Motor Building
Shenzhen 518057
P.R.CHINA

Local sales and technical support

[www.ledil.com/
where_to_buy](http://www.ledil.com/where_to_buy)

Shipping locations

Salo, Finland
Hong Kong, China

Distribution Partners

[www.ledil.com/
where_to_buy](http://www.ledil.com/where_to_buy)