

EMILY-M2

~30° medium beam. 14.88 mm high lens.

TECHNICAL SPECIFICATIONS:

Dimensions	Ø 26.0 mm
Height	14.9 mm
Fastening	tape, pin
ROHS compliant	yes ⓘ

MATERIAL SPECIFICATIONS:

Component	Type	Material	Colour	Finish
EMILY-M2	Single lens	PMMA	clear	
SPUTNIK-TAPE	Tape	Acrylic foam	black	

ORDERING INFORMATION:

Component		Qty in box	MOQ	MPQ	Box weight (kg)
CA11391_EMILY-M2	Single lens	1690	260	130	10.6
» Box size: 480 x 280 x 300 mm					



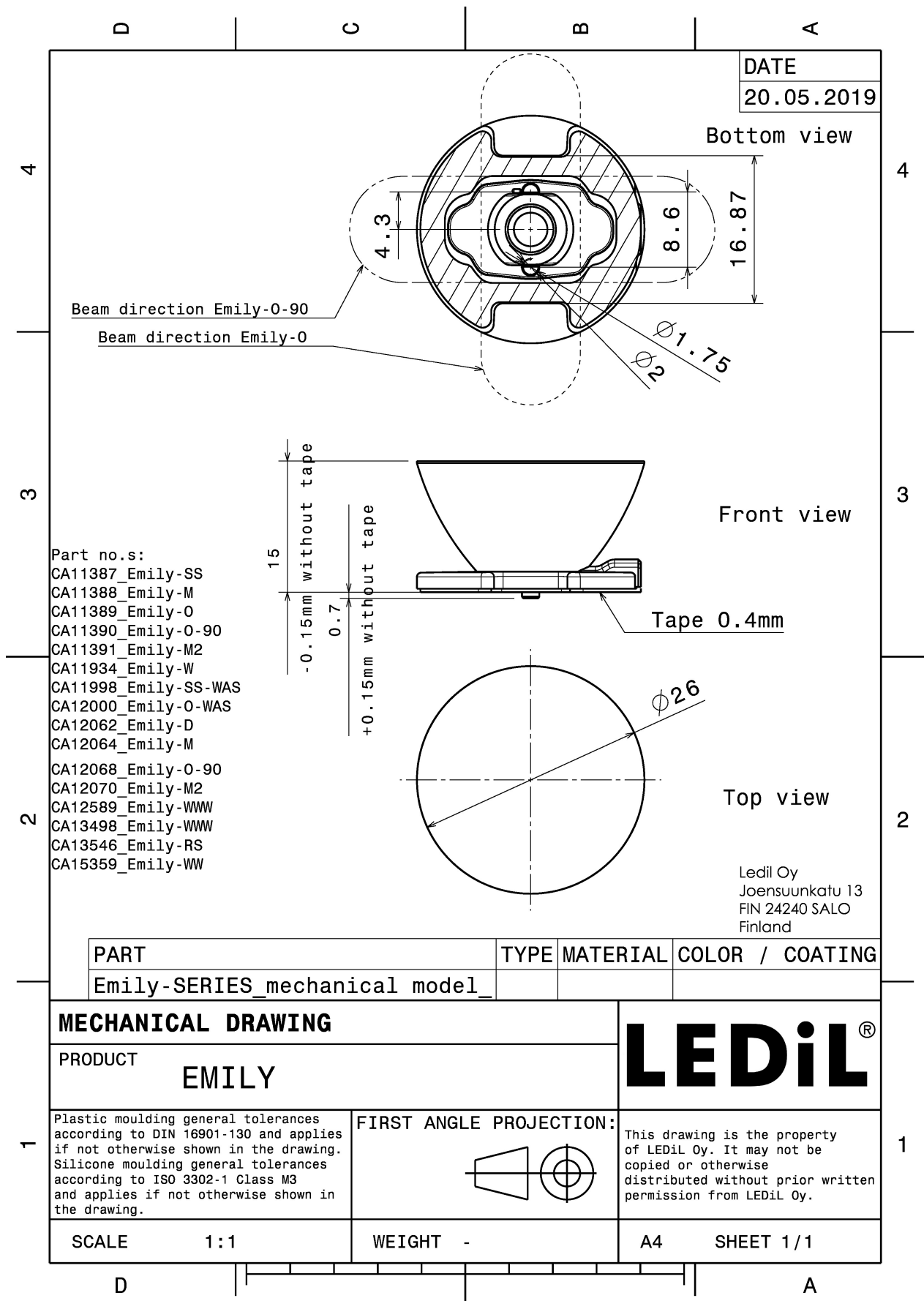



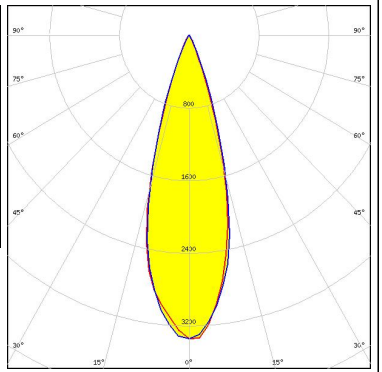

See also our general installation guide: www.ledil.com/installation_guide

PHOTOMETRIC DATA (MEASURED):

<p>CREE → LED</p> <p>LED XB-H FWHM / FWTM 30.0° / 47.0° Efficiency 89 % Peak intensity 3.3 cd/lm LEDs/each optic 1 Light colour White Required components:</p>		
<p>CREE → LED</p> <p>LED XP-E FWHM / FWTM 29.0° / 47.0° Efficiency 92 % Peak intensity 3.2 cd/lm LEDs/each optic 1 Light colour White Required components:</p>		
<p>CREE → LED</p> <p>LED XP-G FWHM / FWTM 29.0° / 44.0° Efficiency 92 % Peak intensity 3.1 cd/lm LEDs/each optic 1 Light colour White Required components:</p>		
<p>LUMILEDS</p> <p>LED LUXEON Rebel FWHM / FWTM 28.0° Efficiency 87 % LEDs/each optic 1 Light colour White Required components:</p>		

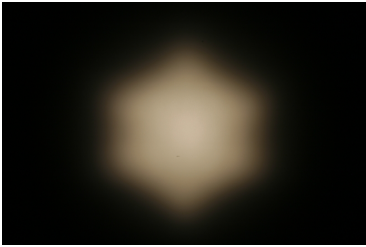
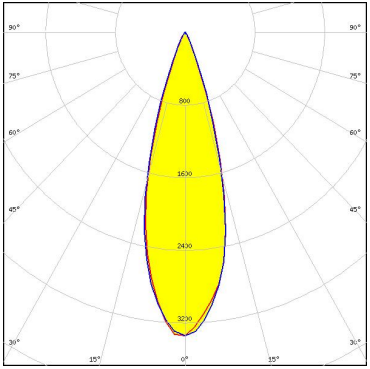
PHOTOMETRIC DATA (MEASURED):

			
LED	NCSxx19A		
FWHM / FWTM	30.0°		
Efficiency	88 %		
LEDs/each optic	1		
Light colour	White		
Required components:			
			
LED	NVSxx19A		
FWHM / FWTM	28.0° / 48.0°		
Efficiency	88 %		
Peak intensity	2.9 cd/m		
LEDs/each optic	1		
Light colour	White		
Required components:			
 <small>Ospto Semiconductors</small>			
LED	OSLON Square EC		
FWHM / FWTM	30.0° / 47.0°		
Efficiency	89 %		
Peak intensity	3.3 cd/m		
LEDs/each optic	1		
Light colour	White		
Required components:			
 <small>Ospto Semiconductors</small>			
LED	OSLON SSL 150		
FWHM / FWTM	30.0°		
Efficiency	%		
LEDs/each optic	1		
Light colour	White		
Required components:			

PHOTOMETRIC DATA (MEASURED):

OSRAM Opto Semiconductors

LED OSLON SSL 80
FWHM / FWTM 28.0°
Efficiency 85 %
LEDs/each optic 1
Light colour White
Required components:



SEOUL SEMICONDUCTOR

LED Z5
FWHM / FWTM 28.0°
Efficiency %
LEDs/each optic 1
Light colour White
Required components:

SHARP

LED Double Dome (GM2BB)
FWHM / FWTM 28.0°
Efficiency %
LEDs/each optic 1
Light colour White
Required components:

PHOTOMETRIC DATA (SIMULATED):

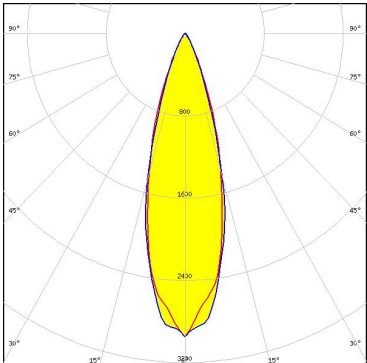
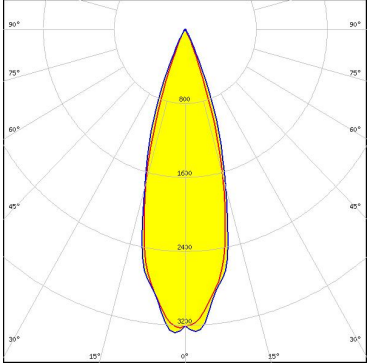
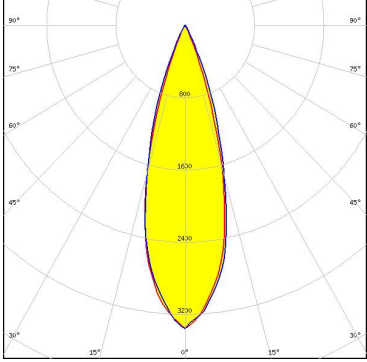
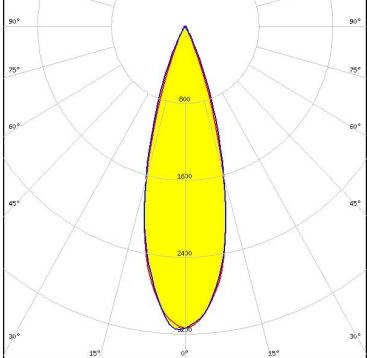
<p>NICHIA</p> <p>LED NCSxx19B FWHM / FWTM 28.0° Efficiency 89 % Peak intensity 2.9 cd/lm LEDs/each optic 1 Light colour White Required components:</p>	
<p>OSRAM Opto Semiconductors</p> <p>LED OSCONIQ P 3030 FWHM / FWTM 31.0° / 49.0° Efficiency 96 % Peak intensity 3.3 cd/lm LEDs/each optic 1 Light colour White Required components:</p>	
<p>OSRAM Opto Semiconductors</p> <p>LED OSOLON Square CSSRM2/CSSRM3 FWHM / FWTM 30.0° / 49.0° Efficiency 94 % Peak intensity 3.4 cd/lm LEDs/each optic 1 Light colour White Required components:</p>	
<p>SAMSUNG</p> <p>LED LH351B FWHM / FWTM 30.0° / 50.0° Efficiency 93 % Peak intensity 3.2 cd/lm LEDs/each optic 1 Light colour White Required components:</p>	

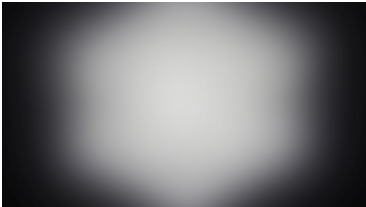

PHOTOMETRIC DATA (SIMULATED):

SAMSUNG

LED	LM28xB Series
FWHM / FWTM	29.0° / 50.0°
Efficiency	94 %
Peak intensity	3.4 cd/lm
LEDs/each optic	1
Light colour	White
Required components:	

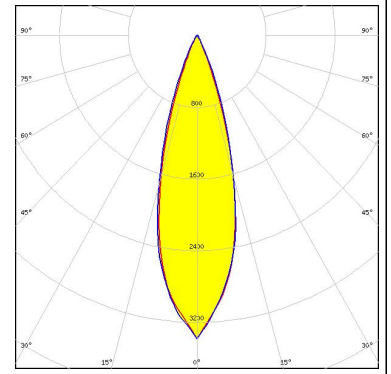

GENERAL INFORMATION:

NOTE: The typical beam angle will be changed by different color, chip size and chip position tolerance. The typical total beam angle is the full angle measured where the luminous intensity is half of the peak value.

MATERIALS:

As part of our continuous research and improvement processes, and to ensure the best possible quality and availability of our products, LEDiL reserves the right to change material grades without notice.

PRODUCT DATA USER AGREEMENT AND DISCLAIMER:

The measured data in the provided downloadable LEDiL Product Datasheets and Mechanical 2D-Drawings is rounded and provided as reference for planning. LEDiL Oy's optical specifications have been verified by conducting performance testing of the products in accordance with the company's quality system. The reported data are averaged results of multiple measurements with typical variation. LEDiL Oy reserves the right to without prior notification make changes and improvements to its products.

LEDiL Oy assumes neither warranty, nor guarantee nor any other liability of any kind for the contents and correctness of the provided data. The provided data has been generated with highest diligence but the provided data may in reality not represent the complete possible variation range of all intrinsic parameters. Therefore, in certain cases a deviation from the provided data could occur.

LEDiL Oy reserves the right to undertake technical changes of its products without further notification which could lead to changes in the provided data. LEDiL Oy assumes no liability of any kind for the possible deviation from any provided data or any other damage resulting from the usage of the provided data.

The user agrees to this disclaimer and user agreement with the download or usage of the provided files.

LEDiL Oy

Joensuunkatu 13
FI-24240 SALO
Finland

LEDiL Inc.

228 West Page Street
Suite D
Sycamore IL 60178
USA

Ledil Optics Technology (Shenzhen) Co., Ltd.

405 , Block B
Casic Motor Building
Shenzhen 518057
P.R.CHINA

Local sales and technical support

[www.ledil.com/
where_to_buy](http://www.ledil.com/where_to_buy)

Shipping locations

Salo, Finland
Hong Kong, China

Distribution Partners

[www.ledil.com/
where_to_buy](http://www.ledil.com/where_to_buy)