

## High Speed Infrared Emitting Diode, 830 nm, GaAlAs Double Hetero

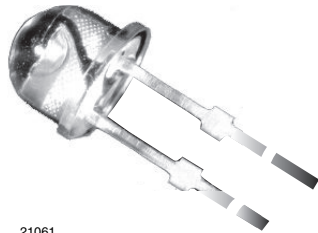

21061

### DESCRIPTION

TSHG5510 is an infrared, 830 nm emitting diode in GaAlAs double hetero (DH) technology with high radiant power and high speed, molded in a clear, untinted plastic package.

### FEATURES

- Package type: leaded
- Package form: T-1 $\frac{3}{4}$
- Dimensions (in mm):  $\varnothing$  5
- Leads with stand-off
- Peak wavelength:  $\lambda_p = 830$  nm
- High reliability
- High radiant power
- High radiant intensity
- Angle of half intensity:  $\varphi = \pm 38^\circ$
- Low forward voltage
- Suitable for high pulse current operation
- High modulation bandwidth:  $f_c = 24$  MHz
- Good spectral matching to Si photodetectors
- Compliant to RoHS Directive 2002/95/EC and in accordance to WEEE 2002/96/EC



### APPLICATIONS

- Infrared radiation source for operation with CMOS cameras (illumination)
- High speed IR data transmission

### PRODUCT SUMMARY

COMPONENT	$I_e$ (mW/sr)	$\varphi$ (deg)	$\lambda_p$ (nm)	$t_r$ (ns)
TSHG5510	32	$\pm 38$	830	15

#### Note

- Test conditions see table "Basic Characteristics"

### ORDERING INFORMATION

ORDERING CODE	PACKAGING	REMARKS	PACKAGE FORM
TSHG5510	Bulk	MOQ: 4000 pcs, 4000 pcs/bulk	T-1 $\frac{3}{4}$

#### Note

- MOQ: minimum order quantity

### ABSOLUTE MAXIMUM RATINGS ( $T_{amb} = 25^\circ\text{C}$ , unless otherwise specified)

PARAMETER	TEST CONDITION	SYMBOL	VALUE	UNIT
Reverse voltage		$V_R$	5	V
Forward current		$I_F$	100	mA
Peak forward current	$t_p/T = 0.5$ , $t_p = 100 \mu\text{s}$	$I_{FM}$	200	mA
Surge forward current	$t_p = 100 \mu\text{s}$	$I_{FSM}$	1	A
Power dissipation		$P_V$	180	mW
Junction temperature		$T_j$	100	$^\circ\text{C}$
Operating temperature range		$T_{amb}$	- 40 to + 85	$^\circ\text{C}$
Storage temperature range		$T_{stg}$	- 40 to + 100	$^\circ\text{C}$
Soldering temperature	$t \leq 5$ s, 2 mm from case	$T_{sd}$	260	$^\circ\text{C}$
Thermal resistance junction/ambient	J-STD-051, leads 7 mm soldered on PCB	$R_{thJA}$	230	K/W

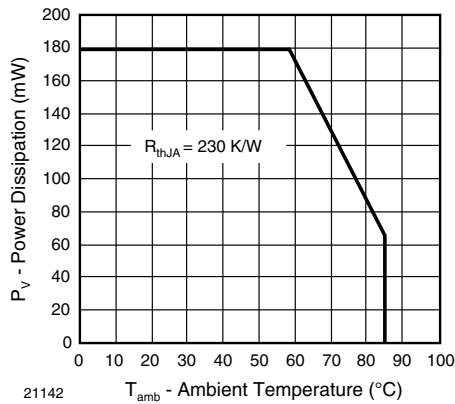

Fig. 1 - Power Dissipation Limit vs. Ambient Temperature

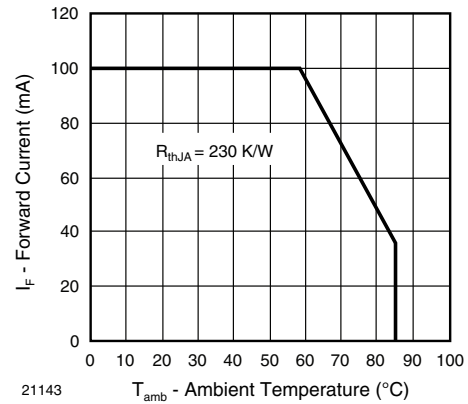

Fig. 2 - Forward Current Limit vs. Ambient Temperature

<b>BASIC CHARACTERISTICS</b> (T <sub>amb</sub> = 25 °C, unless otherwise specified)						
PARAMETER	TEST CONDITION	SYMBOL	MIN.	TYP.	MAX.	UNIT
Forward voltage	I <sub>F</sub> = 100 mA, t <sub>p</sub> = 20 ms	V <sub>F</sub>	1.3	1.45	1.7	V
	I <sub>F</sub> = 450 mA, t <sub>p</sub> = 100 μs	V <sub>F</sub>	1.5	1.75	2.1	V
	I <sub>F</sub> = 1 A, t <sub>p</sub> = 100 μs	V <sub>F</sub>		2.1		V
Temperature coefficient of V <sub>F</sub>	I <sub>F</sub> = 1 mA	TK <sub>V<sub>F</sub></sub>		- 1.8		mV/K
Reverse current	V <sub>R</sub> = 5 V	I <sub>R</sub>			10	μA
Junction capacitance	V <sub>R</sub> = 0 V, f = 1 MHz, E = 0	C <sub>j</sub>		110		pF
Radiant intensity	I <sub>F</sub> = 100 mA, t <sub>p</sub> = 20 ms	I <sub>e</sub>	18	32	54	mW/sr
	I <sub>F</sub> = 1 A, t <sub>p</sub> = 100 μs	I <sub>e</sub>		320		mW/sr
Radiant power	I <sub>F</sub> = 100 mA, t <sub>p</sub> = 20 ms	φ <sub>e</sub>		55		mW
Temperature coefficient of φ <sub>e</sub>	I <sub>F</sub> = 100 mA	TK <sub>φ<sub>e</sub></sub>		- 0.35		%/K
Angle of half intensity		φ		± 38		deg
Peak wavelength	I <sub>F</sub> = 100 mA	λ <sub>p</sub>		830		nm
Spectral bandwidth	I <sub>F</sub> = 100 mA	Δλ		55		nm
Temperature coefficient of λ <sub>p</sub>	I <sub>F</sub> = 100 mA	TKλ <sub>p</sub>		0.25		nm/K
Rise time	I <sub>F</sub> = 100 mA	t <sub>r</sub>		15		ns
Fall time	I <sub>F</sub> = 100 mA	t <sub>f</sub>		15		ns
Cut-off frequency	I <sub>DC</sub> = 70 mA, I <sub>AC</sub> = 30 mA pp	f <sub>c</sub>		24		MHz

**BASIC CHARACTERISTICS** ( $T_{amb} = 25\text{ }^{\circ}\text{C}$ , unless otherwise specified)



Fig. 3 - Pulse Forward Current vs. Pulse Duration

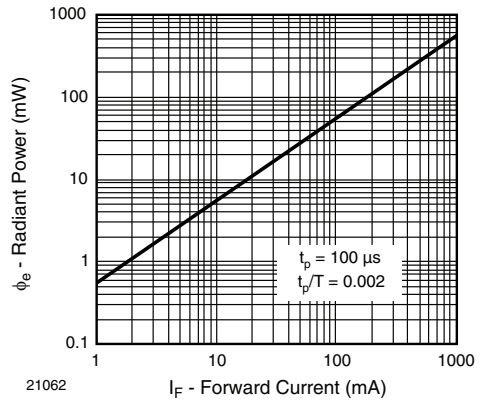

Fig. 6 - Radiant Power vs. Forward Current

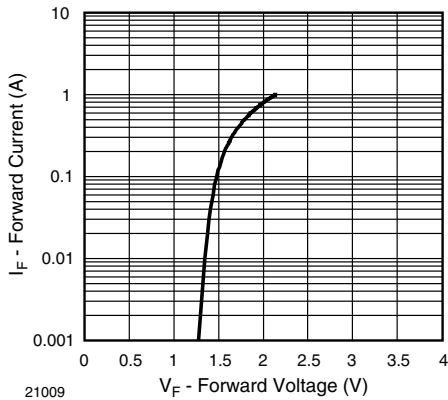

Fig. 4 - Forward Current vs. Forward Voltage

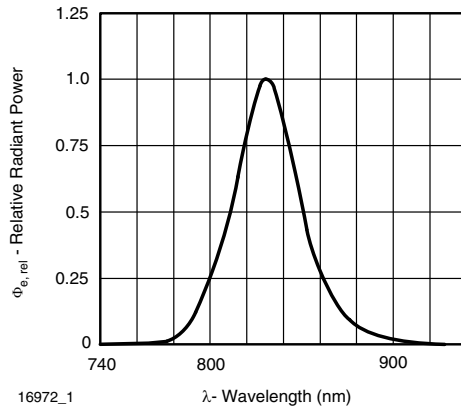

Fig. 7 - Relative Radiant Power vs. Wavelength

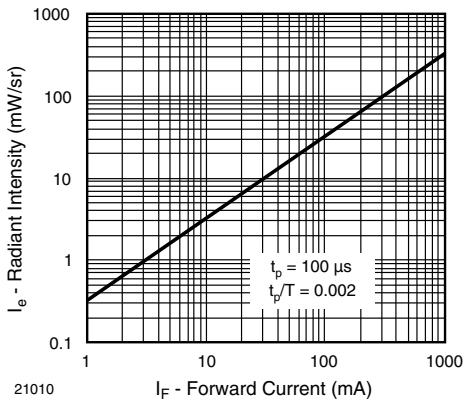

Fig. 5 - Radiant Intensity vs. Forward Current

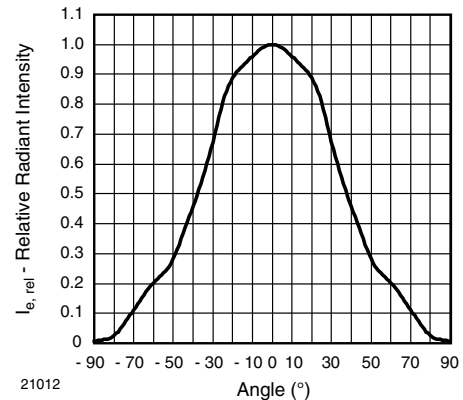
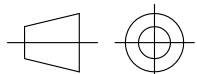
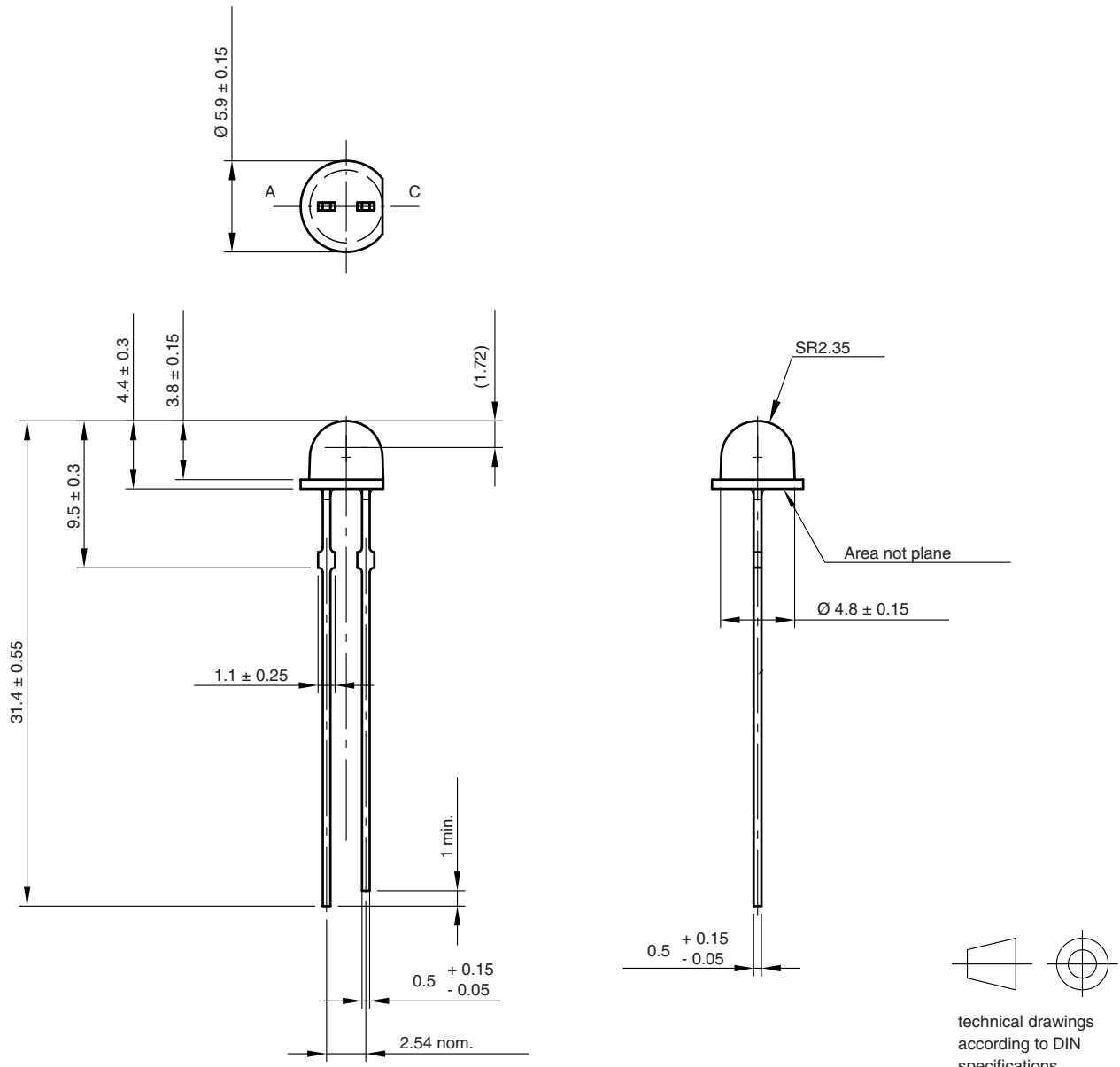

Fig. 8 - Relative Radiant Intensity vs. Angular Displacement



PACKAGE DIMENSIONS in millimeters



technical drawings according to DIN specifications

Drawing-No.: 6.544-5390.01-4  
Issue: 2; 19.05.09  
20796



## Disclaimer

ALL PRODUCT, PRODUCT SPECIFICATIONS AND DATA ARE SUBJECT TO CHANGE WITHOUT NOTICE TO IMPROVE RELIABILITY, FUNCTION OR DESIGN OR OTHERWISE.

Vishay Intertechnology, Inc., its affiliates, agents, and employees, and all persons acting on its or their behalf (collectively, "Vishay"), disclaim any and all liability for any errors, inaccuracies or incompleteness contained in any datasheet or in any other disclosure relating to any product.

Vishay makes no warranty, representation or guarantee regarding the suitability of the products for any particular purpose or the continuing production of any product. To the maximum extent permitted by applicable law, Vishay disclaims (i) any and all liability arising out of the application or use of any product, (ii) any and all liability, including without limitation special, consequential or incidental damages, and (iii) any and all implied warranties, including warranties of fitness for particular purpose, non-infringement and merchantability.

Statements regarding the suitability of products for certain types of applications are based on Vishay's knowledge of typical requirements that are often placed on Vishay products in generic applications. Such statements are not binding statements about the suitability of products for a particular application. It is the customer's responsibility to validate that a particular product with the properties described in the product specification is suitable for use in a particular application. Parameters provided in datasheets and / or specifications may vary in different applications and performance may vary over time. All operating parameters, including typical parameters, must be validated for each customer application by the customer's technical experts. Product specifications do not expand or otherwise modify Vishay's terms and conditions of purchase, including but not limited to the warranty expressed therein.

Hyperlinks included in this datasheet may direct users to third-party websites. These links are provided as a convenience and for informational purposes only. Inclusion of these hyperlinks does not constitute an endorsement or an approval by Vishay of any of the products, services or opinions of the corporation, organization or individual associated with the third-party website. Vishay disclaims any and all liability and bears no responsibility for the accuracy, legality or content of the third-party website or for that of subsequent links.

Except as expressly indicated in writing, Vishay products are not designed for use in medical, life-saving, or life-sustaining applications or for any other application in which the failure of the Vishay product could result in personal injury or death. Customers using or selling Vishay products not expressly indicated for use in such applications do so at their own risk. Please contact authorized Vishay personnel to obtain written terms and conditions regarding products designed for such applications.

No license, express or implied, by estoppel or otherwise, to any intellectual property rights is granted by this document or by any conduct of Vishay. Product names and markings noted herein may be trademarks of their respective owners.