

Features

- * Designed for ease in circuit board assembly.
- * Black case enhance contrast ratio.
- * Solid state light source.
- * Reliable and rugged.

Package Dimensions

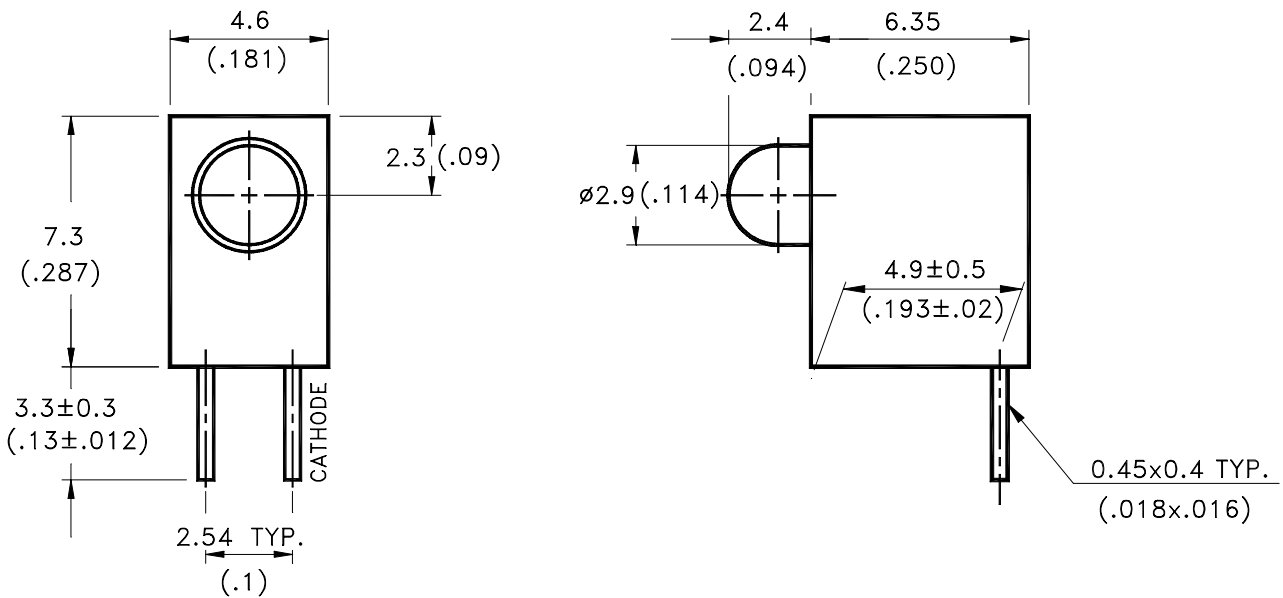

| Part No. | Lens | Source |
|----------|----------------|--------|
| LTL- | | Color |
| 4231N | Green Diffused | Green |

NOTES:

1. All dimensions are in millimeters (inches).
2. Tolerance is $\pm 0.25\text{mm}(.010\text{'})$ unless otherwise noted.
3. The holder color is black.
4. The holder raw material is PBT.
5. The LED lamp is LTL-4231N & the holder is 46L024A.



LITE-ON ELECTRONICS, INC.

Property of Lite-On Only

Absolute Maximum Ratings at Ta=25°C

| Parameter | Maximum Rating | Unit |
|--|---------------------|-------|
| Power Dissipation | 100 | mW |
| Peak Forward Current (1/10 Duty Cycle, 0.1ms Pulse Width) | 120 | mA |
| Continuous Forward Current | 30 | mA |
| Derating Linear From 50°C | 0.4 | mA/°C |
| Reverse Voltage | 5 | V |
| Operating Temperature Range | -55°C to + 100°C | |
| Storage Temperature Range | -55°C to + 100°C | |
| Lead Soldering Temperature [1.6mm(.063") From Body] | 260°C for 5 Seconds | |

Electrical Optical Characteristics at Ta=25°C

| Parameter | Symbol | Part No. LTL- | Min. | Typ. | Max. | Unit | Test Condition |
|--------------------------|-------------------|------------------|------|------|------|------|-----------------------------------|
| Luminous Intensity | I _v | 4231NHCP | 3.7 | 12.6 | | mcd | I _F = 10mA Note 1,4 |
| Viewing Angle | 2θ _{1/2} | 4231NHCP | | 60 | | deg | Note 2 (Fig.6) |
| Peak Emission Wavelength | λ _p | 4231NHCP | | 565 | | nm | Measurement @Peak (Fig.1) |
| Dominant Wavelength | λ _d | 4231NHCP | | 569 | | nm | Note 3 |
| Spectral Line Half-Width | Δλ | 4231NHCP | | 30 | | nm | |
| Forward Voltage | V _F | 4231NHCP | | 2.1 | 2.6 | V | I _F = 20mA |
| Reverse Current | I _R | 4231NHCP | | | 100 | μA | V _R = 5V |
| Capacitance | C | 4231NHCP | | 35 | | PF | V _F = 0 , f = 1MHz |

- Note: 1. Luminous intensity is measured with a light sensor and filter combination that approximates the CIE eye-response curve.
2. θ_{1/2} is the off-axis angle at which the luminous intensity is half the axial luminous intensity.
3. The dominant wavelength, λ_d is derived from the CIE chromaticity diagram and represents the single wavelength which defines the color of the device.
4. I_v needs ±15% additional for guaranteed limits.

Property of Lite-On Only

Typical Electrical / Optical Characteristics Curves

(25°C Ambient Temperature Unless Otherwise Noted)

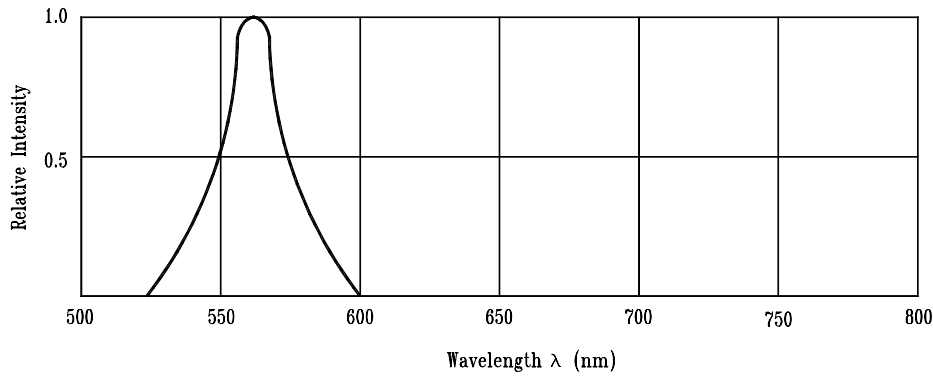

Fig.1 Relative Intensity vs. Wavelength

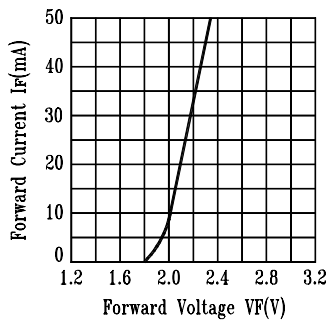

Fig.2 Forward Current vs. Forward Voltage

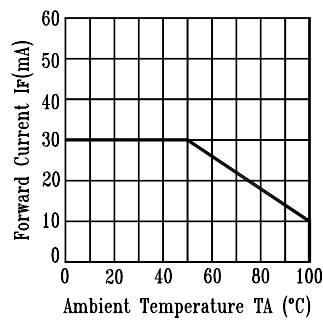

Fig.3 Forward Current Derating Curve

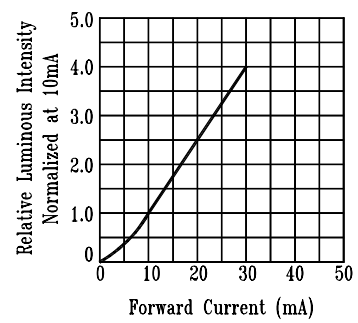

Fig.4 Relative Luminous Intensity vs. Forward Current

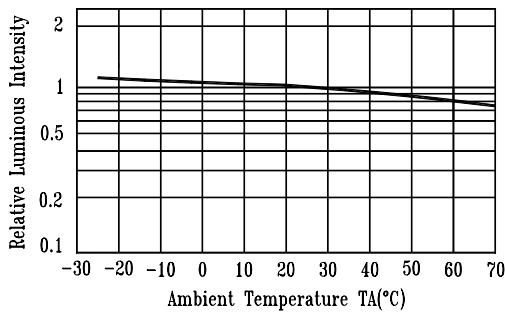

Fig.5 Luminous Intensity vs. Ambient Temperature

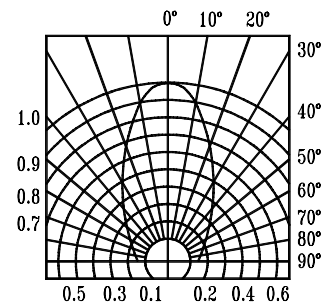

Fig.6 Spatial Distribution

Mouser Electronics

Authorized Distributor

Click to View Pricing, Inventory, Delivery & Lifecycle Information:

[Lite-On:](#)

[LTL-4231NHCP](#)