

TINA2-M

~30° medium beam optimized for Nichia NS6x83.
Assembly with holder and installation tape.

TECHNICAL SPECIFICATIONS:

Dimensions	Ø 16.1 mm
Height	11 mm
Fastening	tape
ROHS compliant	yes ⓘ



MATERIAL SPECIFICATIONS:

Component	Type	Material	Colour	Finish
TINA2-M	Single lens	PMMA	clear	
TINA2-HLD-N83-BLK	Holder	PC	black	
TINA-TAPE3	Tape	Acrylic foam	black	

ORDERING INFORMATION:

Component		Qty in box	MOQ	MPQ	Box weight (kg)
CA11174_TINA2-M	Single lens	4140	230	230	8.4
» Box size: 451 x 241 x 298 mm					

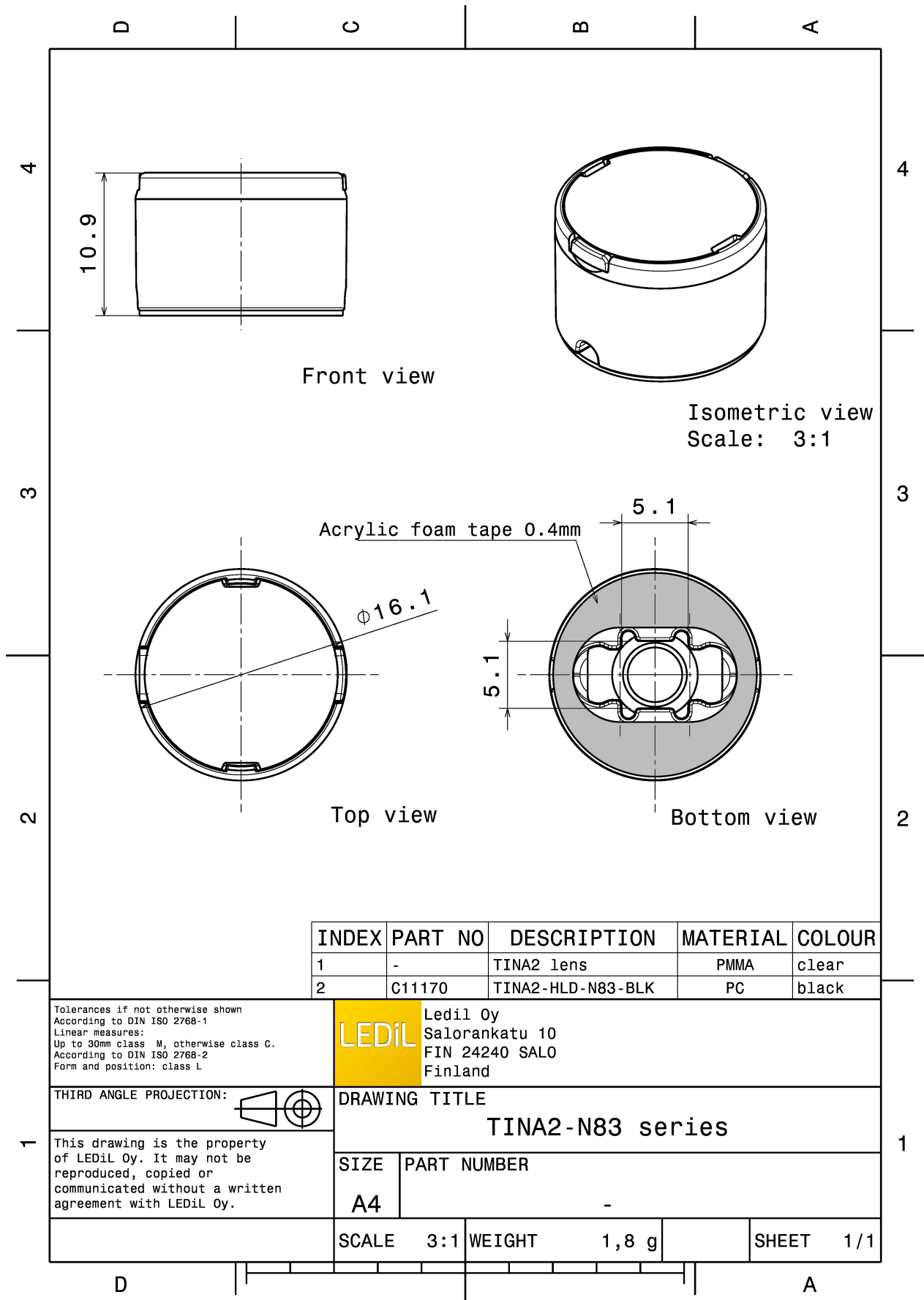

See also our general installation guide: www.ledil.com/installation_guide

PHOTOMETRIC DATA (MEASURED):



LED MX-6
 FWHM / FWTM 30.0° / 60.0°
 Efficiency 83 %
 Peak intensity 2.2 cd/lm
 LEDs/each optic 1
 Light colour White
 Required components:

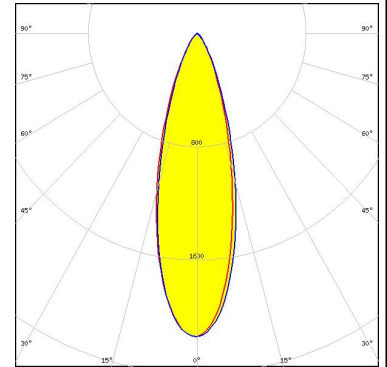

LED LUXEON 5050 Round LES
 FWHM / FWTM 34.0° / 69.0°
 Efficiency 78 %
 Peak intensity 1.6 cd/lm
 LEDs/each optic 1
 Light colour White
 Required components:

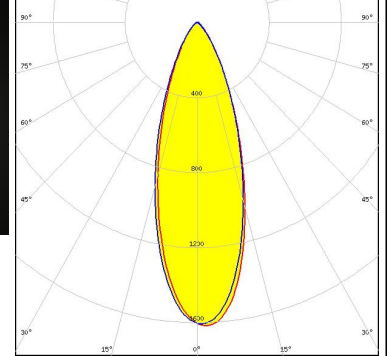

LED LUXEON V
 FWHM / FWTM 32.0° / 63.0°
 Efficiency 75 %
 Peak intensity 1.9 cd/lm
 LEDs/each optic 1
 Light colour White
 Required components:

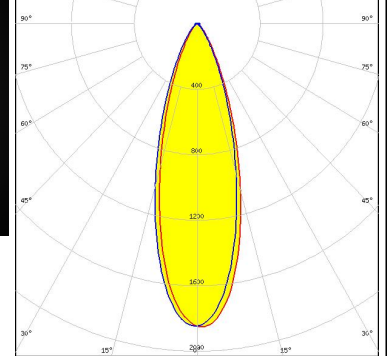
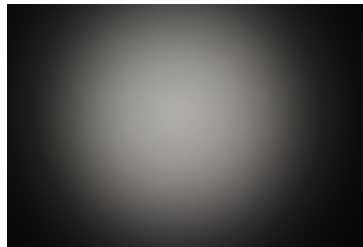

LED NS3x83
 FWHM / FWTM 32.0° / 60.0°
 Efficiency %
 Peak intensity 2.2 cd/lm
 LEDs/each optic 1
 Light colour White
 Required components:

PHOTOMETRIC DATA (MEASURED):

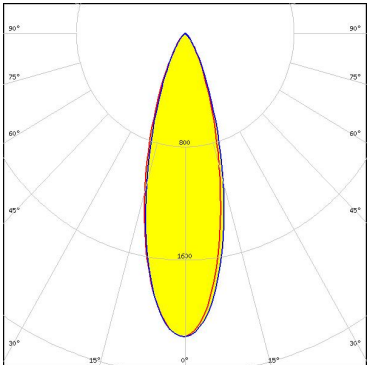
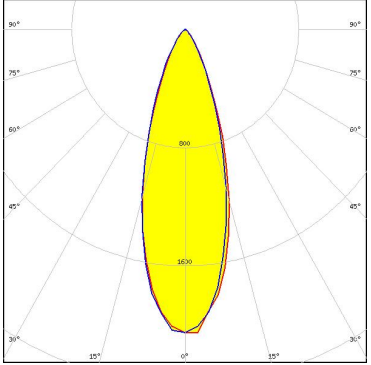
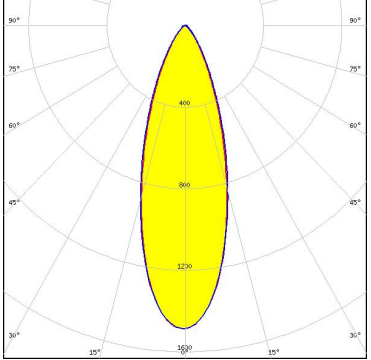





<p>NICHIA</p> <p>LED NS6x83 FWHM / FWTM 30.0° / 60.0° Efficiency 85 % Peak intensity 2.3 cd/lm LEDs/each optic 1 Light colour White Required components:</p>	
<p>OPTOGAN</p> <p>LED OLP-x5050F6L FWHM / FWTM 34.0° / 64.0° Efficiency 86 % Peak intensity 2.1 cd/lm LEDs/each optic 1 Light colour White Required components:</p>	
<p>SAMSUNG</p> <p>LED LH508A FWHM / FWTM 33.0° / 68.0° Efficiency 71 % Peak intensity 1.5 cd/lm LEDs/each optic 1 Light colour White Required components:</p>	

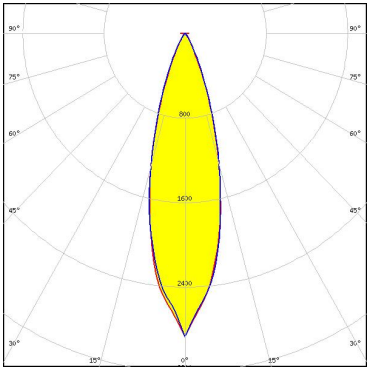

PHOTOMETRIC DATA (SIMULATED):

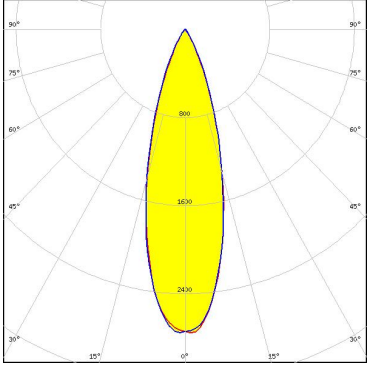
<p>CREE LED</p> <p>LED J Series 5050 Round LES FWHM / FWTM 32.0° / 65.0° Efficiency 83 % Peak intensity 2 cd/lm LEDs/each optic 1 Light colour White Required components:</p>	
<p>CREE LED</p> <p>LED XP-E2 FWHM / FWTM 28.0° / 51.0° Efficiency 90 % Peak intensity 3.4 cd/lm LEDs/each optic 1 Light colour White Required components:</p>	
<p>CREE LED</p> <p>LED XP-G3 FWHM / FWTM 30.0° / 56.0° Efficiency 84 % Peak intensity 2.7 cd/lm LEDs/each optic 1 Light colour White Required components:</p>	
<p>CREE LED</p> <p>LED XP-L HI FWHM / FWTM 30.0° / 54.0° Efficiency 89 % Peak intensity 2.9 cd/lm LEDs/each optic 1 Light colour White Required components:</p>	

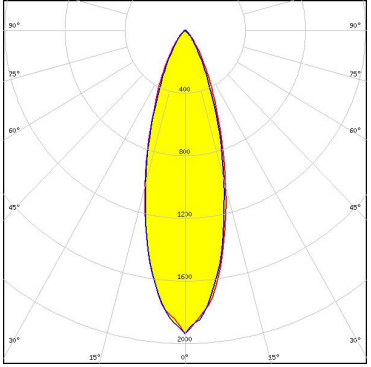
PHOTOMETRIC DATA (SIMULATED):

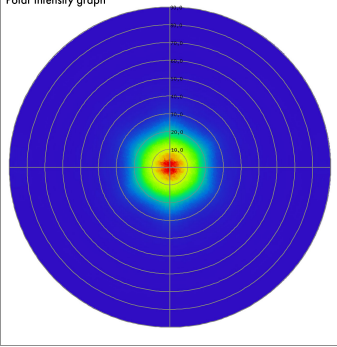
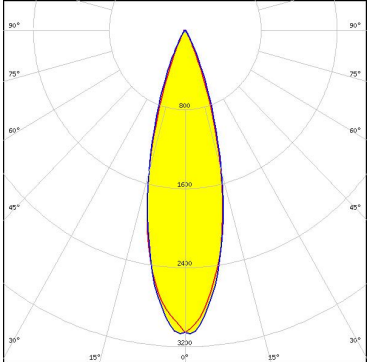
	<p>LED XT-E FWHM / FWTM 28.0° / 52.0° Efficiency 81 % Peak intensity 2.9 cd/lm LEDs/each optic 1 Light colour White Required components:</p>	
	<p>LED NVSW219F FWHM / FWTM 30.0° / 55.0° Efficiency 88 % Peak intensity 2.8 cd/lm LEDs/each optic 1 Light colour White Required components:</p>	
	<p>LED Duris S8 FWHM / FWTM 31.0° / 65.0° Efficiency 78 % Peak intensity 1.9 cd/lm LEDs/each optic 1 Light colour White Required components:</p>	
	<p>LED SFH 4715AS FWHM / FWTM 29.0° / 50.0° Efficiency 87 % LEDs/each optic 1 Light colour IR Required components:</p>	<div data-bbox="772 1606 1110 1966"> <p>Polar intensity graph</p>  </div> <div data-bbox="1129 1606 1501 1966">  </div>

GENERAL INFORMATION:

NOTE: The typical beam angle will be changed by different color, chip size and chip position tolerance. The typical total beam angle is the full angle measured where the luminous intensity is half of the peak value.

MATERIALS:

As part of our continuous research and improvement processes, and to ensure the best possible quality and availability of our products, LEDiL reserves the right to change material grades without notice.

PRODUCT DATA USER AGREEMENT AND DISCLAIMER:

The measured data in the provided downloadable LEDiL Product Datasheets and Mechanical 2D-Drawings is rounded and provided as reference for planning. LEDiL Oy's optical specifications have been verified by conducting performance testing of the products in accordance with the company's quality system. The reported data are averaged results of multiple measurements with typical variation. LEDiL Oy reserves the right to without prior notification make changes and improvements to its products.

LEDiL Oy assumes neither warranty, nor guarantee nor any other liability of any kind for the contents and correctness of the provided data. The provided data has been generated with highest diligence but the provided data may in reality not represent the complete possible variation range of all intrinsic parameters. Therefore, in certain cases a deviation from the provided data could occur.

LEDiL Oy reserves the right to undertake technical changes of its products without further notification which could lead to changes in the provided data. LEDiL Oy assumes no liability of any kind for the possible deviation from any provided data or any other damage resulting from the usage of the provided data.

The user agrees to this disclaimer and user agreement with the download or usage of the provided files.

LEDiL Oy

Joensuunkatu 13
FI-24240 SALO
Finland

LEDiL Inc.

228 West Page Street
Suite D
Sycamore IL 60178
USA

Ledil Optics Technology (Shenzhen) Co., Ltd.

405 , Block B
Casic Motor Building
Shenzhen 518057
P.R.CHINA

Local sales and technical support

[www.ledil.com/
where_to_buy](http://www.ledil.com/where_to_buy)

Shipping locations

Salo, Finland
Hong Kong, China

Distribution Partners

[www.ledil.com/
where_to_buy](http://www.ledil.com/where_to_buy)