

LARISA-O-CLIP8

~40° x 20° oval beam. Clip fastening for 0.8 mm thick PCB.

TECHNICAL SPECIFICATIONS:

Dimensions	9.9 x 9.9 mm
Height	7.5 mm
Fastening	clips
ROHS compliant	yes ⓘ



MATERIAL SPECIFICATIONS:

Component	Type	Material	Colour	Finish
LARISA-O	Single lens	PMMA	clear	
LARISA-HOLDER-CLIP8	Holder	PC	black	



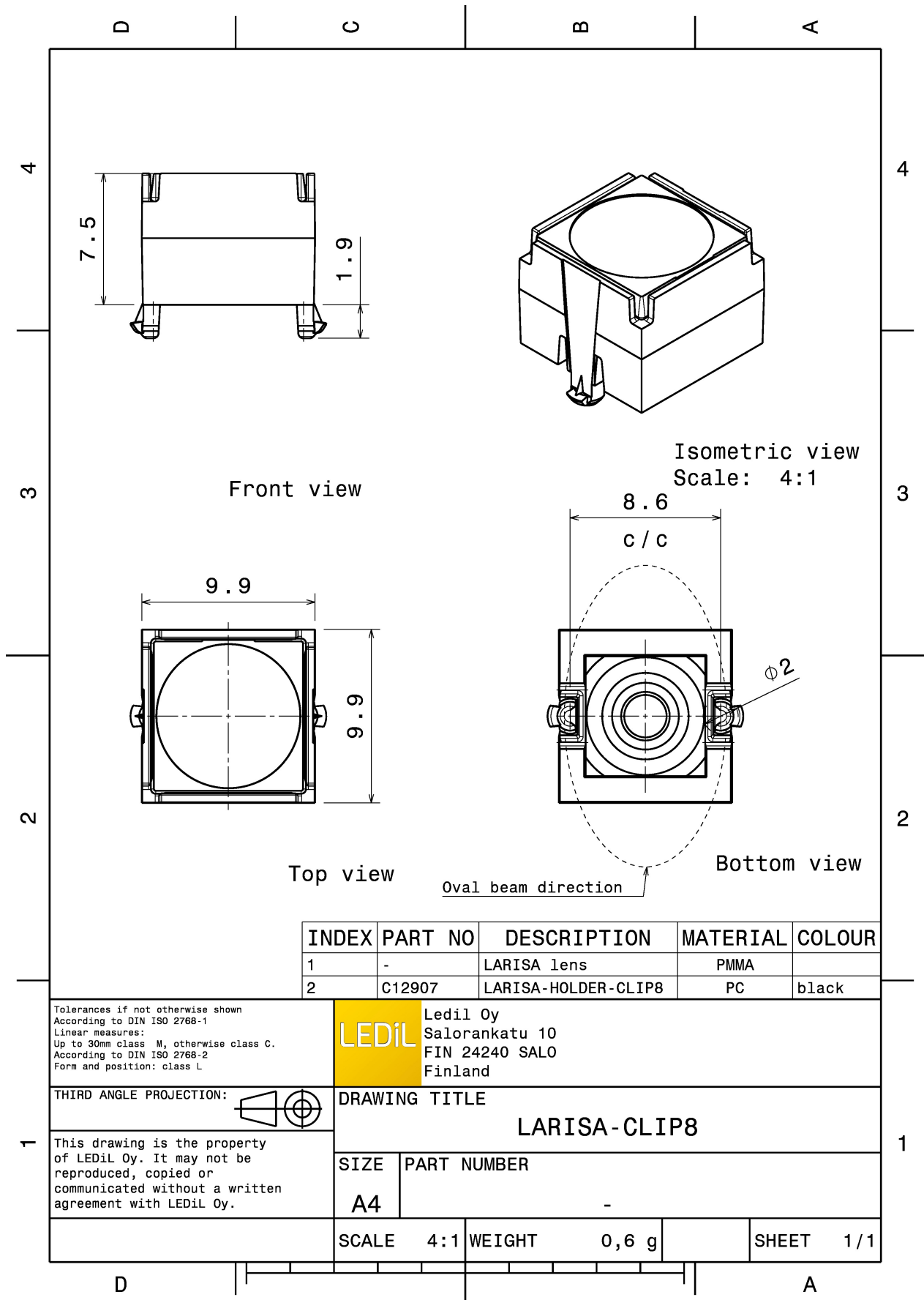

ORDERING INFORMATION:

Component	Type	Qty in box	MOQ	MPQ	Box weight (kg)
CP12942_LARISA-O-CLIP8 » Box size: 300 x 250 x 250 mm	Single lens	10000	300	100	6.8



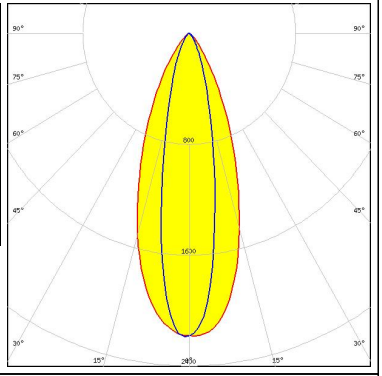

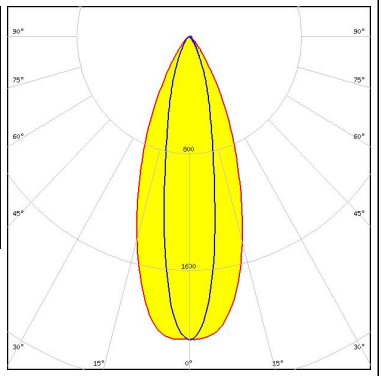
See also our general installation guide: www.ledil.com/installation_guide

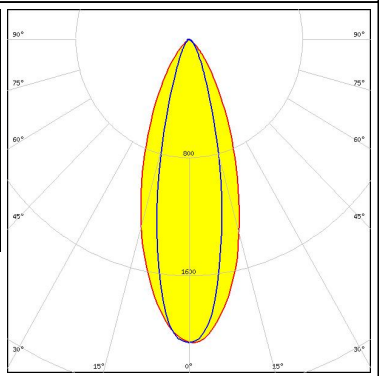
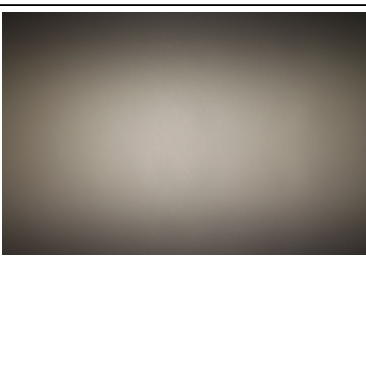
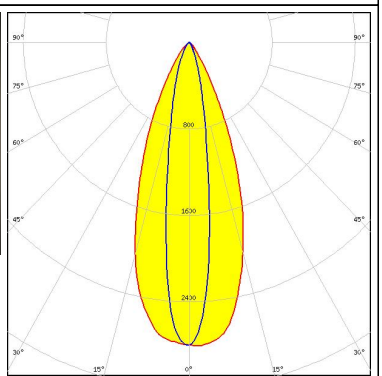
PHOTOMETRIC DATA (MEASURED):

<p>CREE ⇄ LED</p> <p>LED XB-D FWHM / FWTM 39.0 + 21.0° / 73.0 + 49.0° Efficiency 79 % Peak intensity 2.2 cd/lm LEDs/each optic 1 Light colour White Required components:</p>		
<p>CREE ⇄ LED</p> <p>LED XD16 FWHM / FWTM 40.0 + 20.0° / 72.0 + 51.0° Efficiency 75 % Peak intensity 2.1 cd/lm LEDs/each optic 1 Light colour White Required components:</p>		
<p>CREE ⇄ LED</p> <p>LED XP-G FWHM / FWTM 39.0 + 25.0° / 76.0 + 51.0° Efficiency 83 % Peak intensity 2.1 cd/lm LEDs/each optic 1 Light colour White Required components:</p>		
<p>CREE ⇄ LED</p> <p>LED XQ-E HD FWHM / FWTM 40.0 + 17.0° / 68.0 + 42.0° Efficiency 82 % Peak intensity 2.8 cd/lm LEDs/each optic 1 Light colour White Required components:</p>		

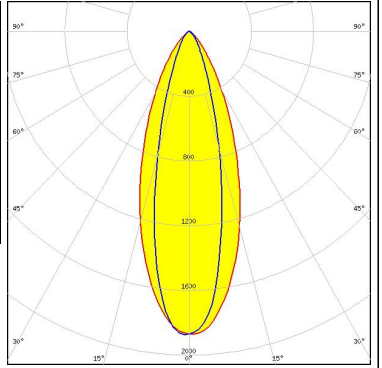
PHOTOMETRIC DATA (MEASURED):

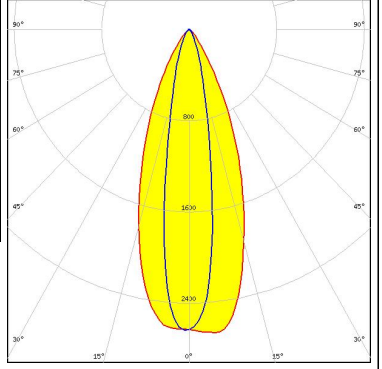
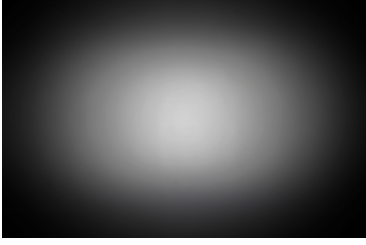
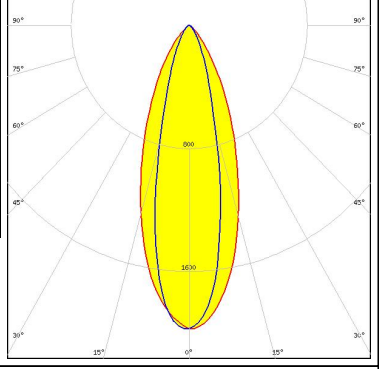
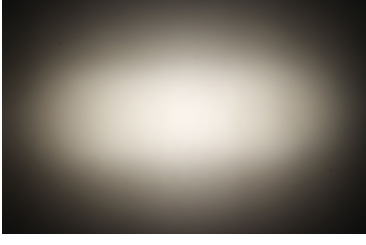
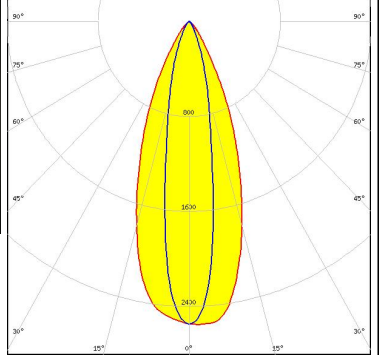
<p>LUMILEDS</p> <p>LED LUXEON A</p> <p>FWHM / FWTM 39.0 + 26.0° / 78.0 + 55.0°</p> <p>Efficiency 81 %</p> <p>Peak intensity 1.9 cd/lm</p> <p>LEDs/each optic 1</p> <p>Light colour White</p> <p>Required components:</p>		
<p>LUMILEDS</p> <p>LED LUXEON Rebel</p> <p>FWHM / FWTM 40.0 + 18.0° / 70.0 + 42.0°</p> <p>Efficiency 84 %</p> <p>Peak intensity 2.7 cd/lm</p> <p>LEDs/each optic 1</p> <p>Light colour White</p> <p>Required components:</p>		
<p>LUMILEDS</p> <p>LED LUXEON Rebel ES</p> <p>FWHM / FWTM 39.0 + 25.0° / 77.0 + 54.0°</p> <p>Efficiency 82 %</p> <p>Peak intensity 2 cd/lm</p> <p>LEDs/each optic 1</p> <p>Light colour White</p> <p>Required components:</p>		
<p>LUMILEDS</p> <p>LED LUXEON Rebel Plus</p> <p>FWHM / FWTM 40.0 + 19.0° / 69.0 + 46.0°</p> <p>Efficiency 83 %</p> <p>Peak intensity 2.6 cd/lm</p> <p>LEDs/each optic 1</p> <p>Light colour White</p> <p>Required components:</p>		

PHOTOMETRIC DATA (MEASURED):

LUMILEDS

LED LUXEON Z
 FWHM / FWTM 41.0 + 14.0° / 62.0 + 36.0°
 Efficiency 81 %
 Peak intensity 3.5 cd/lm
 LEDs/each optic 1
 Light colour White
 Required components:



LUMILEDS

LED LUXEON Z ES
 FWHM / FWTM 40.0 + 18.0° / 68.0 + 44.0°
 Efficiency 86 %
 Peak intensity 2.8 cd/lm
 LEDs/each optic 1
 Light colour White
 Required components:

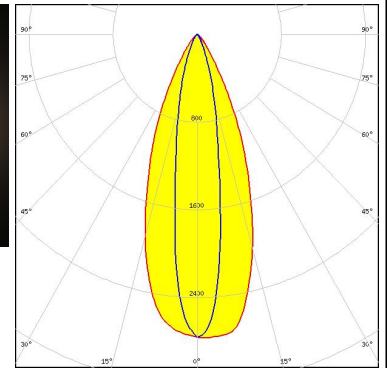
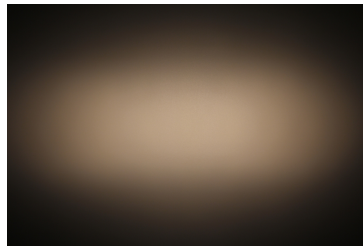

NICHIA

LED NCSxx19A
 FWHM / FWTM 41.0 + 19.0° / 71.0 + 50.0°
 Efficiency 81 %
 Peak intensity 2.3 cd/lm
 LEDs/each optic 1
 Light colour White
 Required components:

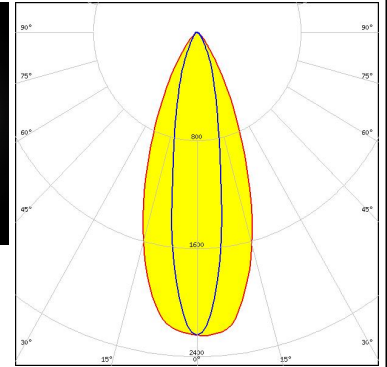

NICHIA

LED NF2x757A
 FWHM / FWTM 41.0 + 33.0° / 75.0 + 60.0°
 Efficiency 78 %
 Peak intensity 2 cd/lm
 LEDs/each optic 1
 Light colour White
 Required components:

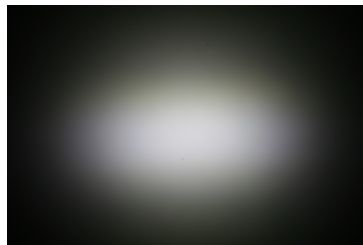

PHOTOMETRIC DATA (MEASURED):



LED NF2x757G
 FWHM / FWTM 42.0 + 25.0° / 80.0 + 70.0°
 Efficiency 76 %
 Peak intensity 1.5 cd/lm
 LEDs/each optic 1
 Light colour White
 Required components:



LED NVSxx19A
 FWHM / FWTM 40.0 + 24.0° / 77.0 + 57.0°
 Efficiency 79 %
 Peak intensity 1.9 cd/lm
 LEDs/each optic 1
 Light colour White
 Required components:

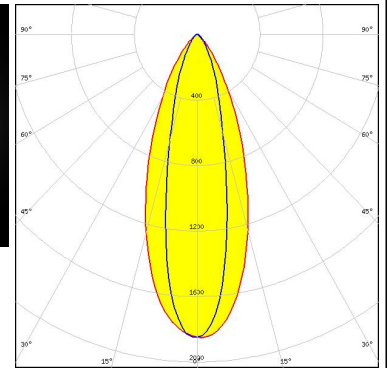
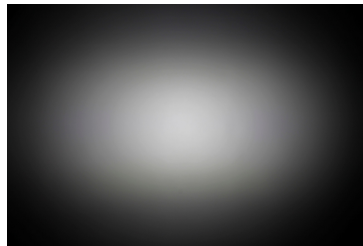

LED Duris S5 (2 chip)
 FWHM / FWTM 26.0 + 41.0° / 63.0 + 77.0°
 Efficiency 85 %
 Peak intensity 1.8 cd/lm
 LEDs/each optic 1
 Light colour White
 Required components:

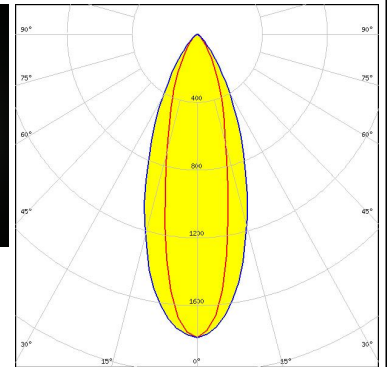
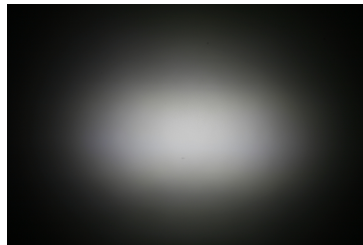

LED OSLOM Square EC
 FWHM / FWTM 40.0 + 22.0° / 74.0 + 55.0°
 Efficiency 78 %
 Peak intensity 2 cd/lm
 LEDs/each optic 1
 Light colour White
 Required components:

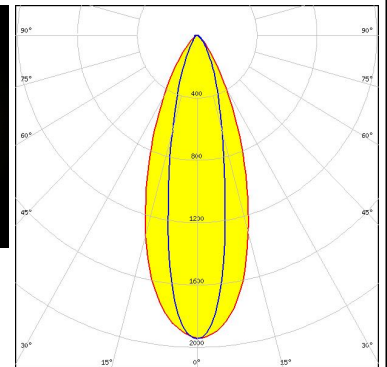
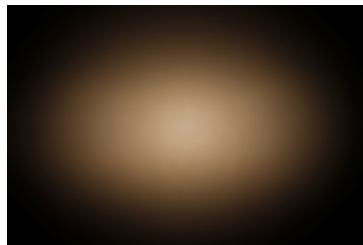

PHOTOMETRIC DATA (MEASURED):

OSRAM

Opto Semiconductors

LED OSLON SSL 150
 FWHM / FWTM 39.0 + 19.0° / 70.0 + 40.0°
 Efficiency 84 %
 Peak intensity 2.9 cd/lm
 LEDs/each optic 1
 Light colour White
 Required components:

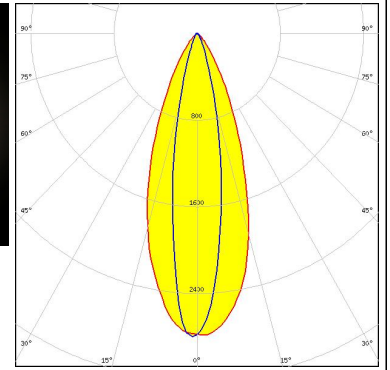

OSRAM

Opto Semiconductors

LED OSLON SSL 80
 FWHM / FWTM 40.0 + 17.0° / 70.0 + 48.0°
 Efficiency 77 %
 Peak intensity 2.5 cd/lm
 LEDs/each optic 1
 Light colour White
 Required components:

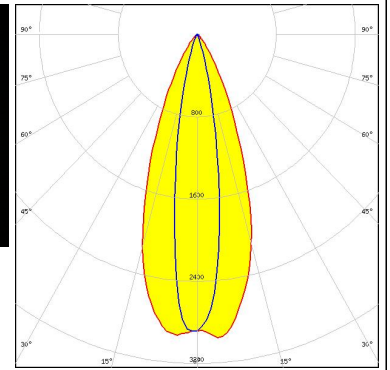
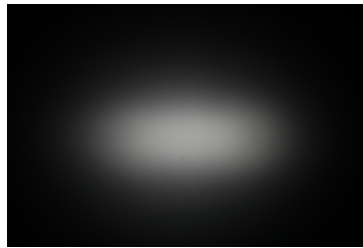

PHOTOMETRIC DATA (SIMULATED):



LED J Series 2835
 FWHM / FWTM 40.0 + 19.0° / 72.0 + 50.0°
 Efficiency 82 %
 Peak intensity 2.4 cd/lm
 LEDs/each optic 1
 Light colour White
 Required components:

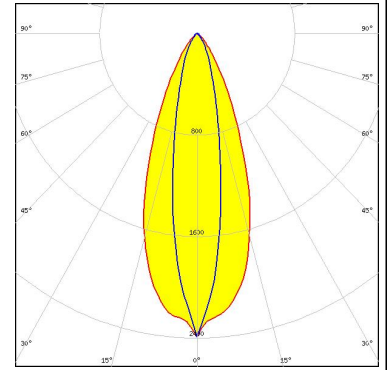

LED XQ-E HI
 FWHM / FWTM 40.0 + 14.0° / 64.0 + 29.0°
 Efficiency 89 %
 Peak intensity 4.1 cd/lm
 LEDs/each optic 1
 Light colour White
 Required components:

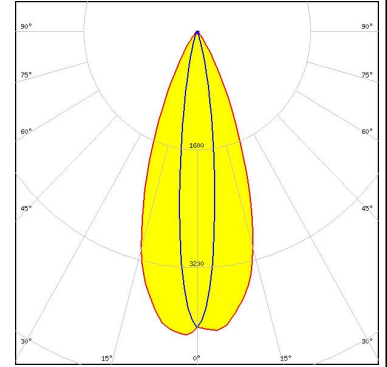

LED NCSxE17A
 FWHM / FWTM 18.0 + 40.0° / 42.0 + 68.0°
 Efficiency 79 %
 Peak intensity 2.7 cd/lm
 LEDs/each optic 1
 Light colour White
 Required components:

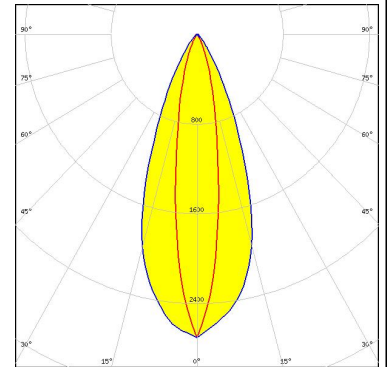

GENERAL INFORMATION:

NOTE: The typical beam angle will be changed by different color, chip size and chip position tolerance. The typical total beam angle is the full angle measured where the luminous intensity is half of the peak value.

MATERIALS:

As part of our continuous research and improvement processes, and to ensure the best possible quality and availability of our products, LEDiL reserves the right to change material grades without notice.

PRODUCT DATA USER AGREEMENT AND DISCLAIMER:

The measured data in the provided downloadable LEDiL Product Datasheets and Mechanical 2D-Drawings is rounded and provided as reference for planning. LEDiL Oy's optical specifications have been verified by conducting performance testing of the products in accordance with the company's quality system. The reported data are averaged results of multiple measurements with typical variation. LEDiL Oy reserves the right to without prior notification make changes and improvements to its products.

LEDiL Oy assumes neither warranty, nor guarantee nor any other liability of any kind for the contents and correctness of the provided data. The provided data has been generated with highest diligence but the provided data may in reality not represent the complete possible variation range of all intrinsic parameters. Therefore, in certain cases a deviation from the provided data could occur.

LEDiL Oy reserves the right to undertake technical changes of its products without further notification which could lead to changes in the provided data. LEDiL Oy assumes no liability of any kind for the possible deviation from any provided data or any other damage resulting from the usage of the provided data.

The user agrees to this disclaimer and user agreement with the download or usage of the provided files.

LEDiL Oy

Joensuunkatu 13
FI-24240 SALO
Finland

LEDiL Inc.

228 West Page Street
Suite D
Sycamore IL 60178
USA

Ledil Optics Technology (Shenzhen) Co., Ltd.

405 , Block B
Casic Motor Building
Shenzhen 518057
P.R.CHINA

Local sales and technical support

[www.ledil.com/
where_to_buy](http://www.ledil.com/where_to_buy)

Shipping locations

Salo, Finland
Hong Kong, China

Distribution Partners

[www.ledil.com/
where_to_buy](http://www.ledil.com/where_to_buy)