

## STRADA-SQ-T4

IESNA Type IV beam for wider roads and large outdoor areas. Version with location pins. Assembly with installation tape.

### TECHNICAL SPECIFICATIONS:

Dimensions	25.0 x 25.0 mm
Height	9.4 mm
Fastening	tape, pin, screw
ROHS compliant	yes ⓘ

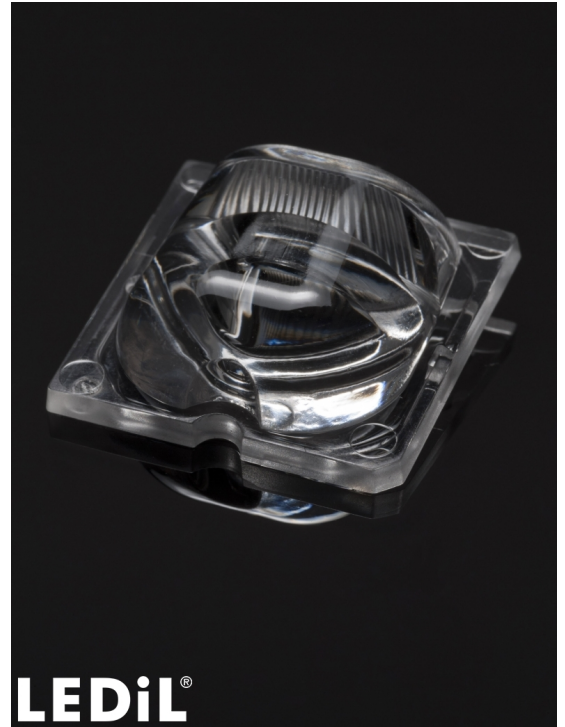

### MATERIAL SPECIFICATIONS:

Component	Type	Material	Colour	Finish
STRADA-SQ-T4	Single lens	PMMA	clear	
ROSE-TAPE	Tape	Acrylic foam	black	

### ORDERING INFORMATION:

Component	Qty in box	MOQ	MPQ	Box weight (kg)
CA14032_STRADA-SQ-T4 » Box size:			98	7.6

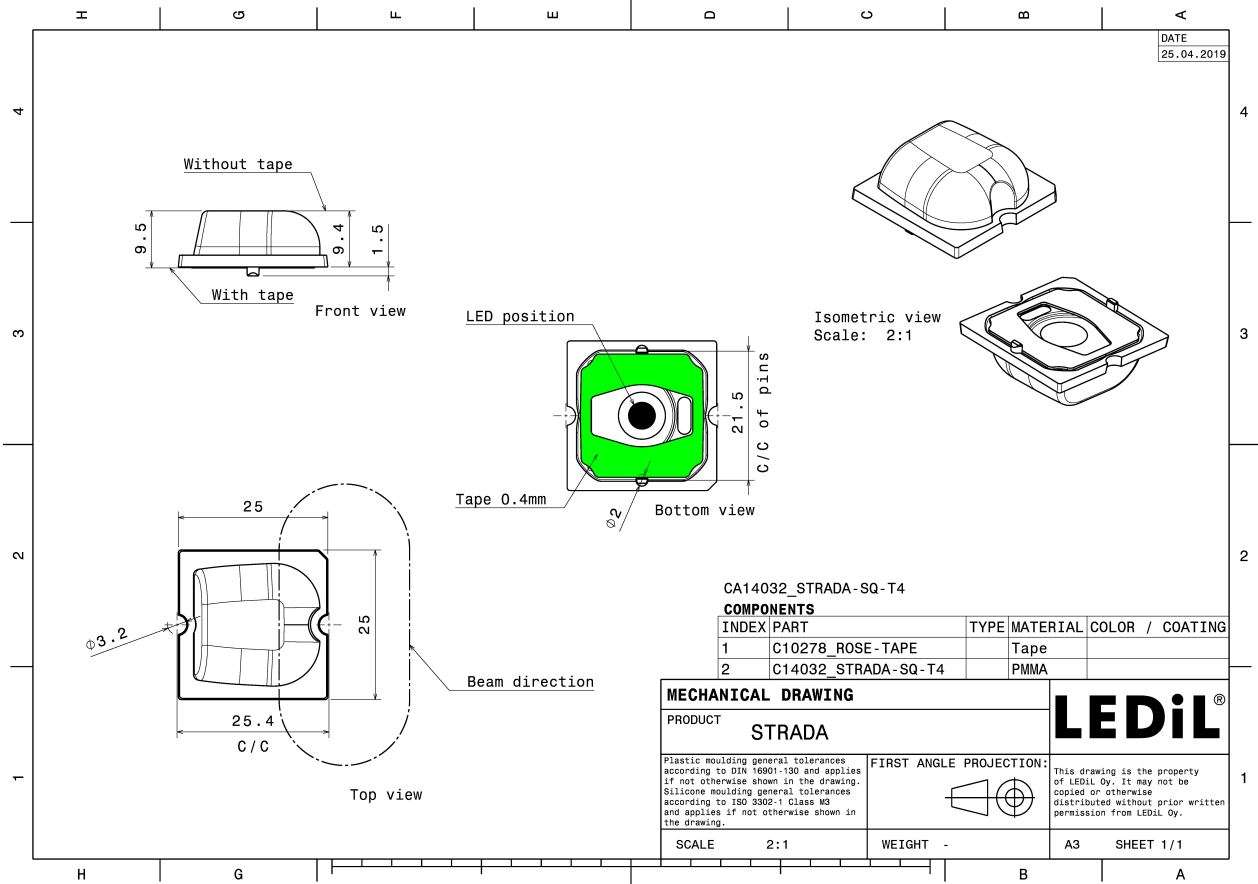

See also our general installation guide: [www.ledil.com/installation\\_guide](http://www.ledil.com/installation_guide)

### PHOTOMETRIC DATA (MEASURED):

#### CREE LED

LED MK-R  
FWHM / FWTM Asymmetric  
Efficiency 92 %  
Peak intensity 0.5 cd/lm  
LEDs/each optic 1  
Light colour White  
Required components:

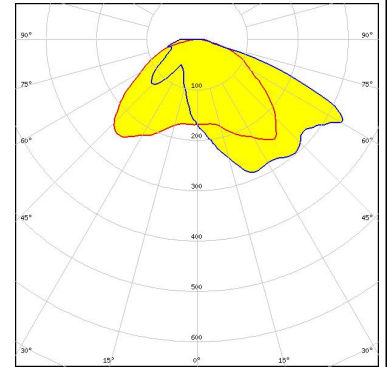

#### CREE LED

LED XHP50  
FWHM / FWTM Asymmetric  
Efficiency 93 %  
Peak intensity 0.6 cd/lm  
LEDs/each optic 1  
Light colour White  
Required components:

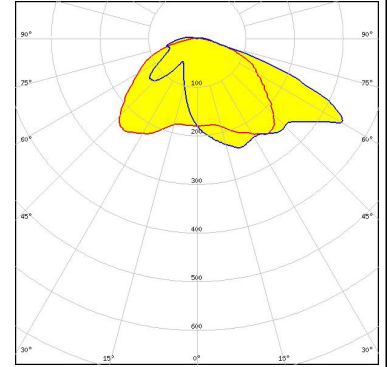

#### LUMILEDS

LED LUXEON M/MX  
FWHM / FWTM Asymmetric  
Efficiency 92 %  
Peak intensity 0.5 cd/lm  
LEDs/each optic 1  
Light colour White  
Required components:

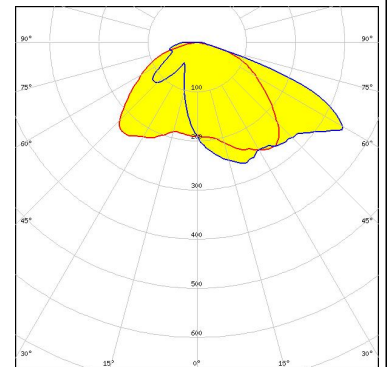

#### LUMILEDS

LED LUXEON MZ  
FWHM / FWTM Asymmetric  
Efficiency 93 %  
Peak intensity 0.7 cd/lm  
LEDs/each optic 1  
Light colour White  
Required components:

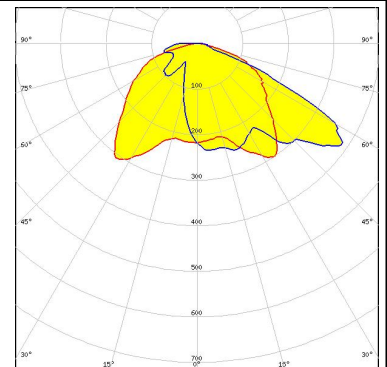

#### PHOTOMETRIC DATA (MEASURED):

##### LUMILEDS

LED LUXEON TX  
 FWHM / FWTM Asymmetric  
 Efficiency 93 %  
 Peak intensity 0.7 cd/lm  
 LEDs/each optic 1  
 Light colour White  
 Required components:

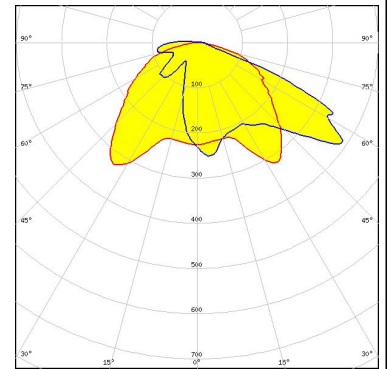

##### LUMILEDS

LED LUXEON XR-M linear 1x3, 1x4, 1x5  
 FWHM / FWTM Asymmetric  
 Efficiency 94 %  
 Peak intensity 0.6 cd/lm  
 LEDs/each optic 1  
 Light colour White  
 Required components:

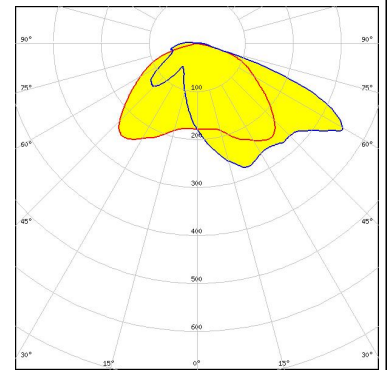

##### NICHIA

LED NV4x144A  
 FWHM / FWTM Asymmetric  
 Efficiency 92 %  
 Peak intensity 0.6 cd/lm  
 LEDs/each optic 1  
 Light colour White  
 Required components:

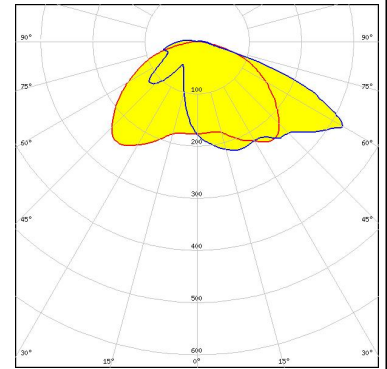

##### NICHIA

LED NVSW319B  
 FWHM / FWTM Asymmetric  
 Efficiency 93 %  
 Peak intensity 0.7 cd/lm  
 LEDs/each optic 1  
 Light colour White  
 Required components:

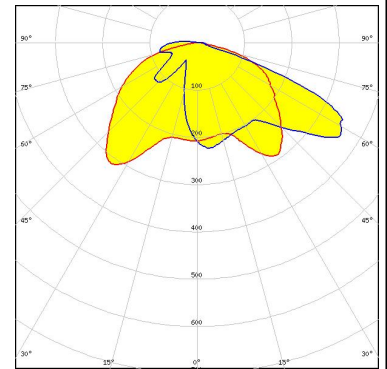

### PHOTOMETRIC DATA (MEASURED):

#### OSRAM Opto Semiconductors

LED Duris S10  
FWHM / FWTM Asymmetric  
Efficiency 91 %  
Peak intensity 0.5 cd/lm  
LEDs/each optic 1  
Light colour White  
Required components:

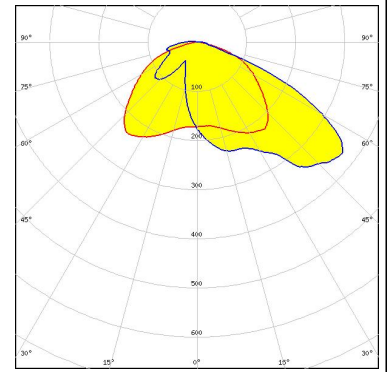

#### OSRAM Opto Semiconductors

LED Duris S8  
FWHM / FWTM Asymmetric  
Efficiency 94 %  
Peak intensity 0.6 cd/lm  
LEDs/each optic 1  
Light colour White  
Required components:

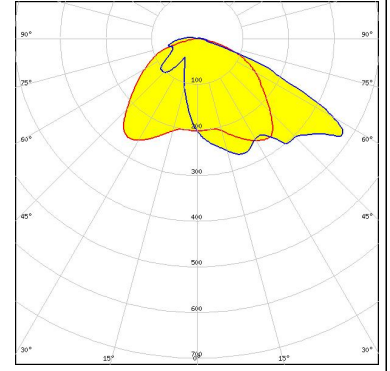

#### SEOUL SEMICONDUCTOR

LED Z8Y50P  
FWHM / FWTM Asymmetric  
Efficiency 89 %  
Peak intensity 0.5 cd/lm  
LEDs/each optic 1  
Light colour White  
Required components:

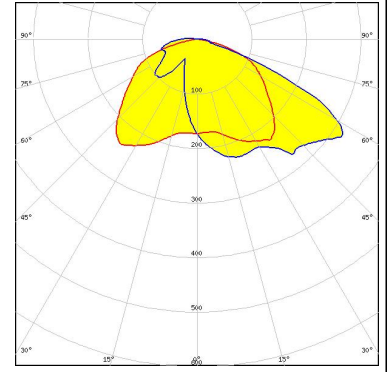

#### PHOTOMETRIC DATA (SIMULATED):

<p><b>CREE</b> LED</p> <p>LED: MHB-A/B            FWHM / FWTM: Asymmetric            Efficiency: 92 %            Peak intensity: 0.5 cd/lm            LEDs/each optic: 1            Light colour: White            Required components:</p>	
<p><b>CREE</b> LED</p> <p>LED: XHP50.3 HD            FWHM / FWTM: Asymmetric            Efficiency: 92 %            Peak intensity: 0.5 cd/lm            LEDs/each optic: 1            Light colour: White            Required components:</p>	
<p><b>CREE</b> LED</p> <p>LED: XHP50.3 HI            FWHM / FWTM: Asymmetric            Efficiency: 94 %            Peak intensity: 0.5 cd/lm            LEDs/each optic: 1            Light colour: White            Required components:</p>	
<p><b>CREE</b> LED</p> <p>LED: XM-L2            FWHM / FWTM: Asymmetric            Efficiency: 95 %            Peak intensity: 0.6 cd/lm            LEDs/each optic: 1            Light colour: White            Required components:</p>	

#### PHOTOMETRIC DATA (SIMULATED):

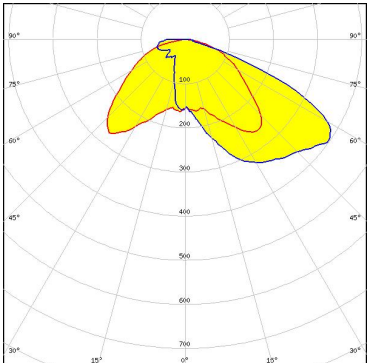
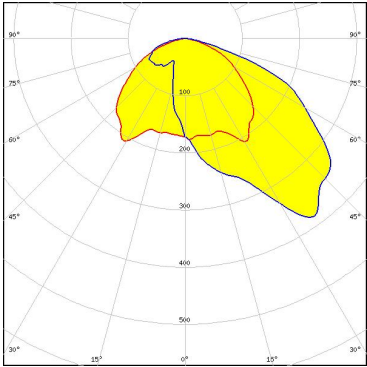
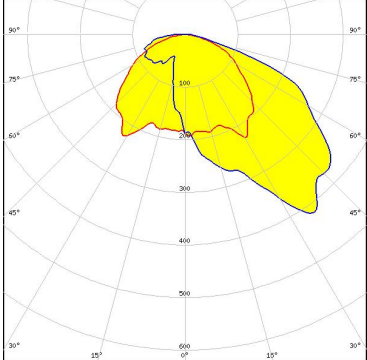
<p><b>LUMILEDS</b></p> <p>LED: LUXEON 5050 Round LES</p> <p>FWHM / FWTM: Asymmetric</p> <p>Efficiency: 94 %</p> <p>Peak intensity: 0.6 cd/lm</p> <p>LEDs/each optic: 1</p> <p>Light colour: White</p> <p>Required components:</p>	
<p><b>NICHIA</b></p> <p>LED: NVSW219F</p> <p>FWHM / FWTM: Asymmetric</p> <p>Efficiency: 95 %</p> <p>Peak intensity: 0.6 cd/lm</p> <p>LEDs/each optic: 1</p> <p>Light colour: White</p> <p>Required components:</p>	
<p><b>NICHIA</b></p> <p>LED: NVSxE21A</p> <p>FWHM / FWTM: Asymmetric</p> <p>Efficiency: 79 %</p> <p>Peak intensity: 0.4 cd/lm</p> <p>LEDs/each optic: 9</p> <p>Light colour: White</p> <p>Required components:</p> <p>Protective plate, glass</p>	
<p><b>NICHIA</b></p> <p>LED: NVSxE21A</p> <p>FWHM / FWTM: Asymmetric</p> <p>Efficiency: 93 %</p> <p>Peak intensity: 0.5 cd/lm</p> <p>LEDs/each optic: 9</p> <p>Light colour: White</p> <p>Required components:</p>	

#### PHOTOMETRIC DATA (SIMULATED):

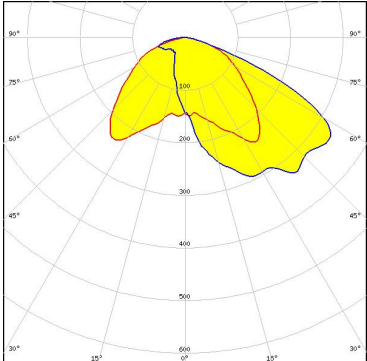
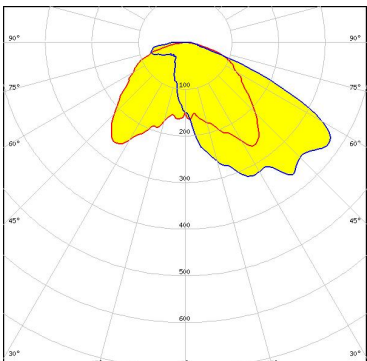
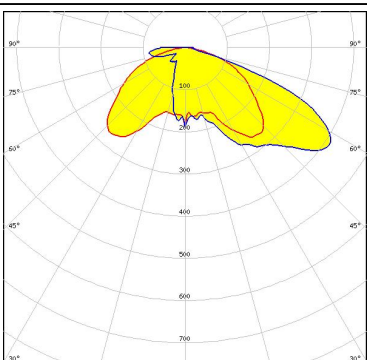
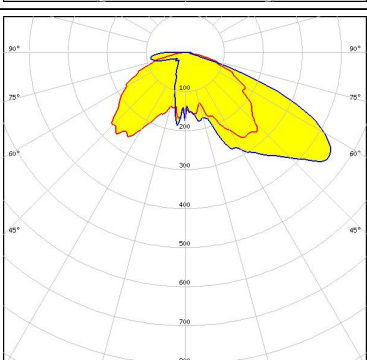
<p><b>NICHIA</b></p> <p>LED NVSxE21A            FWHM / FWTM Asymmetric            Efficiency 79 %            Peak intensity 0.4 cd/lm            LEDs/each optic 4            Light colour White            Required components:</p> <p style="background-color: #ADD8E6; padding: 2px; display: inline-block;">Protective plate, glass</p>	
<p><b>NICHIA</b></p> <p>LED NVSxE21A            FWHM / FWTM Asymmetric            Efficiency 94 %            Peak intensity 0.6 cd/lm            LEDs/each optic 4            Light colour White            Required components:</p>	
<p><b>NICHIA</b></p> <p>LED NVSxx19B/NVSxx19C            FWHM / FWTM Asymmetric            Efficiency 93 %            Peak intensity 0.6 cd/lm            LEDs/each optic 1            Light colour White            Required components:</p>	
<p><b>NICHIA</b></p> <p>LED NVSxx19B/NVSxx19C            FWHM / FWTM Asymmetric            Efficiency 92 %            LEDs/each optic 1            Light colour White            Required components:</p>	



#### PHOTOMETRIC DATA (SIMULATED):

##### OSRAM

Opto Semiconductors

LED OSCONIQ P 3737 (2W version)  
FWHM / FWTM Asymmetric  
Efficiency 94 %  
Peak intensity 0.7 cd/lm  
LEDs/each optic 1  
Light colour White  
Required components:

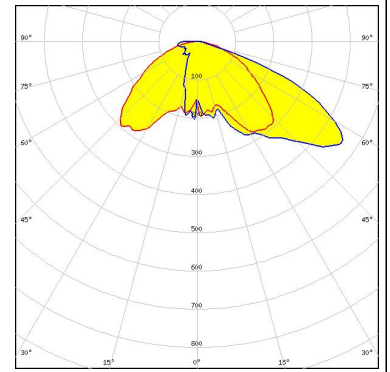

##### OSRAM

Opto Semiconductors

LED OSCONIQ P 7070  
FWHM / FWTM Asymmetric  
Efficiency 91 %  
Peak intensity 0.6 cd/lm  
LEDs/each optic 1  
Light colour White  
Required components:

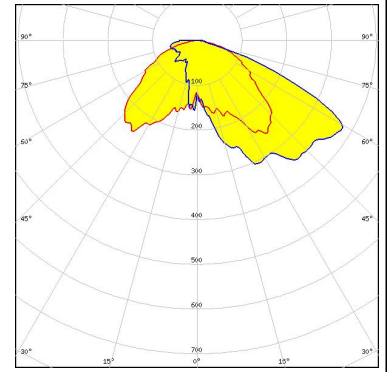

#### GENERAL INFORMATION:

NOTE: The typical beam angle will be changed by different color, chip size and chip position tolerance. The typical total beam angle is the full angle measured where the luminous intensity is half of the peak value.

#### MATERIALS:

As part of our continuous research and improvement processes, and to ensure the best possible quality and availability of our products, LEDiL reserves the right to change material grades without notice.

#### PRODUCT DATA USER AGREEMENT AND DISCLAIMER:

The measured data in the provided downloadable LEDiL Product Datasheets and Mechanical 2D-Drawings is rounded and provided as reference for planning. LEDiL Oy's optical specifications have been verified by conducting performance testing of the products in accordance with the company's quality system. The reported data are averaged results of multiple measurements with typical variation. LEDiL Oy reserves the right to without prior notification make changes and improvements to its products.

LEDiL Oy assumes neither warranty, nor guarantee nor any other liability of any kind for the contents and correctness of the provided data. The provided data has been generated with highest diligence but the provided data may in reality not represent the complete possible variation range of all intrinsic parameters. Therefore, in certain cases a deviation from the provided data could occur.

LEDiL Oy reserves the right to undertake technical changes of its products without further notification which could lead to changes in the provided data. LEDiL Oy assumes no liability of any kind for the possible deviation from any provided data or any other damage resulting from the usage of the provided data.

The user agrees to this disclaimer and user agreement with the download or usage of the provided files.

#### LEDiL Oy

Joensuunkatu 13  
FI-24240 SALO  
Finland

#### LEDiL Inc.

228 West Page Street  
Suite D  
Sycamore IL 60178  
USA

#### Ledil Optics Technology (Shenzhen) Co., Ltd.

# 405 , Block B  
Casic Motor Building  
Shenzhen 518057  
P.R.CHINA

#### Local sales and technical support

[www.ledil.com/  
where\\_to\\_buy](http://www.ledil.com/where_to_buy)

#### Shipping locations

Salo, Finland  
Hong Kong, China

#### Distribution Partners

[www.ledil.com/  
where\\_to\\_buy](http://www.ledil.com/where_to_buy)