

## ANNA-40-7-W

~30° wide beam with 7 optics

### TECHNICAL SPECIFICATIONS:

Dimensions	Ø 40.0 mm
Height	10.7 mm
Fastening	pin
ROHS compliant	yes ⓘ

### MATERIAL SPECIFICATIONS:

Component	Type	Material	Colour	Finish
ANNA-40-7-W	Multi-lens	PMMA	clear	

### ORDERING INFORMATION:

Component	Qty in box	MOQ	MPQ	Box weight (kg)
C13485_ANNA-40-7-W » Box size: 480 x 280 x 300 mm	760	120	40	7.5



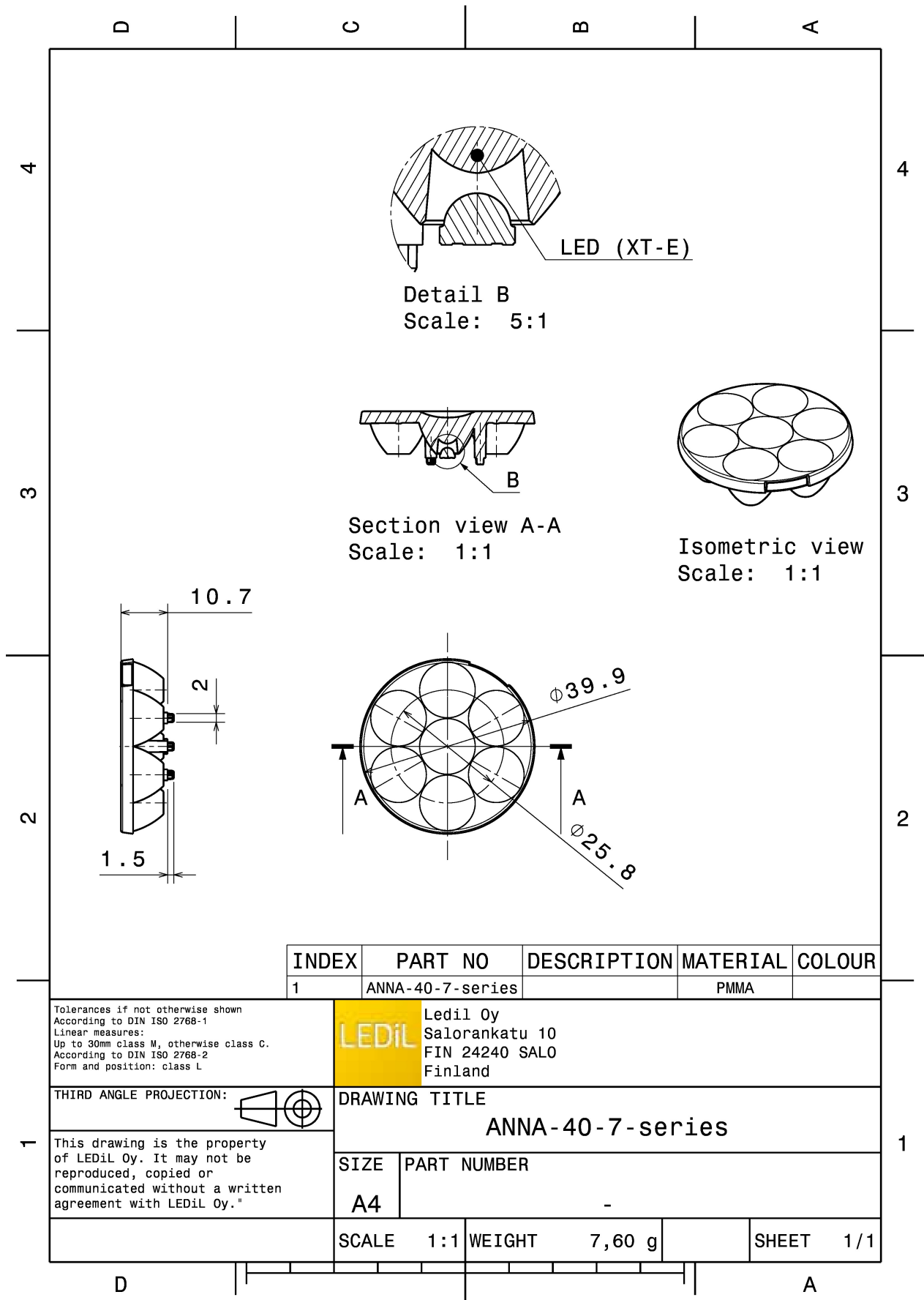

INDEX	PART NO	DESCRIPTION	MATERIAL	COLOUR
1	ANNA-40-7-series		PMMA	

Tolerances if not otherwise shown  
According to DIN ISO 2768-1  
Linear measures:  
Up to 30mm class M, otherwise class C.  
According to DIN ISO 2768-2  
Form and position: class L

**LEDiL** LediL Oy  
Salorankatu 10  
FIN 24240 SALO  
Finland

THIRD ANGLE PROJECTION:

DRAWING TITLE  
**ANNA-40-7-series**

This drawing is the property of LEDiL Oy. It may not be reproduced, copied or communicated without a written agreement with LEDiL Oy."

SIZE	PART NUMBER
A4	-

SCALE	1:1	WEIGHT	7,60 g	SHEET	1/1
-------	-----	--------	--------	-------	-----

See also our general installation guide: [www.ledil.com/installation\\_guide](http://www.ledil.com/installation_guide)

#### PHOTOMETRIC DATA (MEASURED):

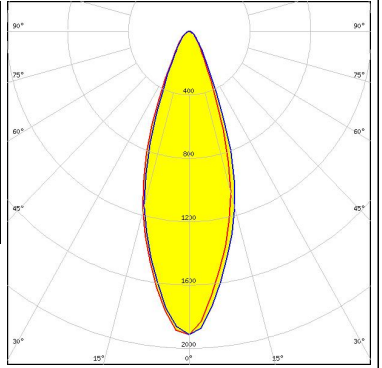
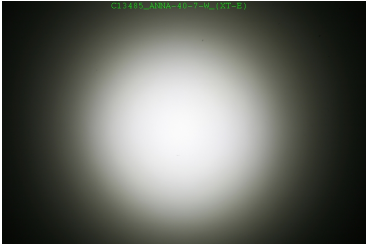
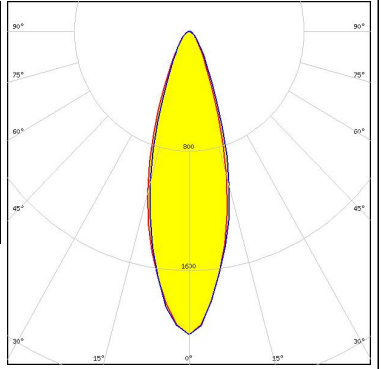
<p><b>CREE</b> LED</p> <p>LED                    XP-G2            FWHM / FWTM    36.0° / 65.0°            Efficiency            88 %            Peak intensity     2 cd/lm            LEDs/each optic   1            Light colour        White            Required components:</p>		
<p><b>CREE</b> LED</p> <p>LED                    XT-E            FWHM / FWTM    33.0° / 62.0°            Efficiency            86 %            Peak intensity     2 cd/lm            LEDs/each optic   1            Light colour        White            Required components:</p>		

#### PHOTOMETRIC DATA (SIMULATED):

<p><b>CREE</b> → <b>LED</b></p> <p>LED J Series 2835            FWHM / FWTM 27.0° / 54.0°            Efficiency 96 %            Peak intensity 3.2 cd/lm            LEDs/each optic 1            Light colour White            Required components:</p>	
<p><b>CREE</b> → <b>LED</b></p> <p>LED XB-D            FWHM / FWTM 35.4° / 60.9°            Efficiency 89 %            Peak intensity 2.3 cd/lm            LEDs/each optic 1            Light colour White            Required components:</p>	
<p><b>CREE</b> → <b>LED</b></p> <p>LED XP-G            FWHM / FWTM 42.0° / 67.0°            Efficiency 92 %            Peak intensity 1.9 cd/lm            LEDs/each optic 1            Light colour White            Required components:</p>	
<p><b>CREE</b> → <b>LED</b></p> <p>LED XP-L HD            FWHM / FWTM 41.0° / 77.0°            Efficiency 88 %            Peak intensity 1.5 cd/lm            LEDs/each optic 1            Light colour White            Required components:</p>	

#### PHOTOMETRIC DATA (SIMULATED):

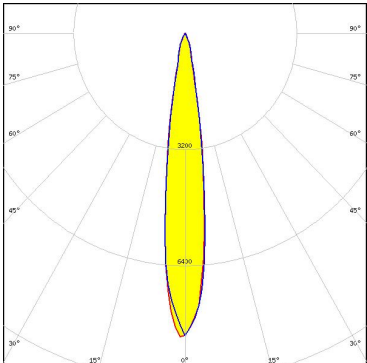
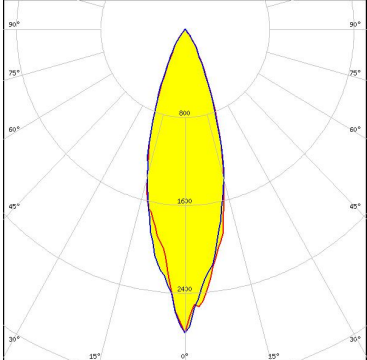
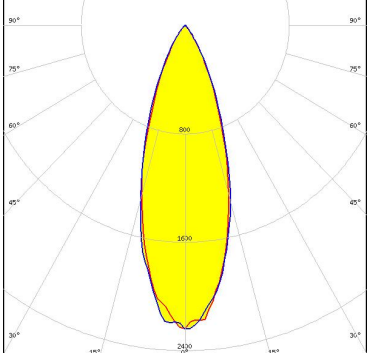
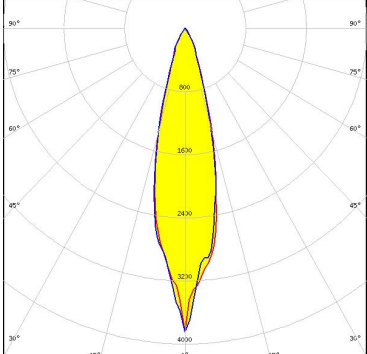
<p><b>LUMILEDS</b></p> <p>LED LUXEON PWT</p> <p>FWHM / FWTM 14.7° / 29.1°</p> <p>Efficiency 88 %</p> <p>Peak intensity 8.6 cd/lm</p> <p>LEDs/each optic 1</p> <p>Light colour White</p> <p>Required components:</p>	
<p><b>LUMILEDS</b></p> <p>LED LUXEON T</p> <p>FWHM / FWTM 30.0° / 58.0°</p> <p>Efficiency 92 %</p> <p>Peak intensity 2.9 cd/lm</p> <p>LEDs/each optic 1</p> <p>Light colour White</p> <p>Required components:</p>	
<p><b>LUMILEDS</b></p> <p>LED LUXEON TX</p> <p>FWHM / FWTM 34.0° / 64.0°</p> <p>Efficiency 92 %</p> <p>Peak intensity 2.2 cd/lm</p> <p>LEDs/each optic 1</p> <p>Light colour White</p> <p>Required components:</p>	
<p><b>NICHIA</b></p> <p>LED NCSxx19A</p> <p>FWHM / FWTM 24.1° / 47.1°</p> <p>Efficiency 88 %</p> <p>Peak intensity 3.8 cd/lm</p> <p>LEDs/each optic 1</p> <p>Light colour White</p> <p>Required components:</p>	

#### PHOTOMETRIC DATA (SIMULATED):

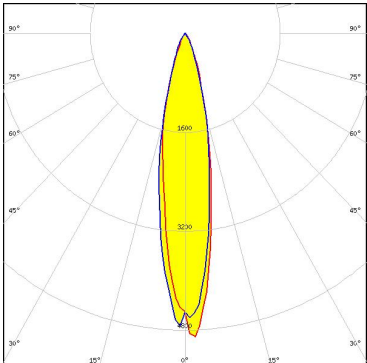
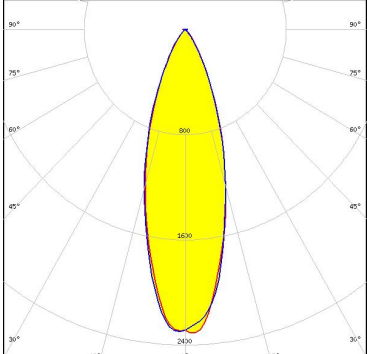
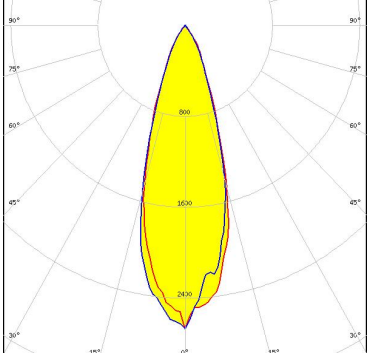
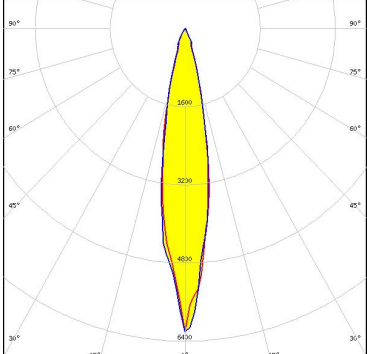
<p><b>NICHIA</b></p> <p>LED NF2x757A            FWHM / FWTM 19.5° / 43.6°            Efficiency 92 %            Peak intensity 5 cd/lm            LEDs/each optic 1            Light colour White            Required components:</p>	
<p><b>NICHIA</b></p> <p>LED NVSxx19B/NVSxx19C            FWHM / FWTM 32.0° / 63.0°            Efficiency 92 %            Peak intensity 2.3 cd/lm            LEDs/each optic 1            Light colour White            Required components:</p>	
<p><b>OSRAM</b>  <small>Opto Semiconductors</small></p> <p>LED OSLON Square EC            FWHM / FWTM 31.5° / 59.2°            Efficiency 91 %            Peak intensity 2.8 cd/lm            LEDs/each optic 1            Light colour White            Required components:</p>	
<p><b>OSRAM</b>  <small>Opto Semiconductors</small></p> <p>LED SFH 4715S            FWHM / FWTM 18.0° / 36.0°            Efficiency 89 %            Peak intensity 6.6 cd/lm            LEDs/each optic 1            Light colour White            Required components:</p>	

#### PHOTOMETRIC DATA (SIMULATED):

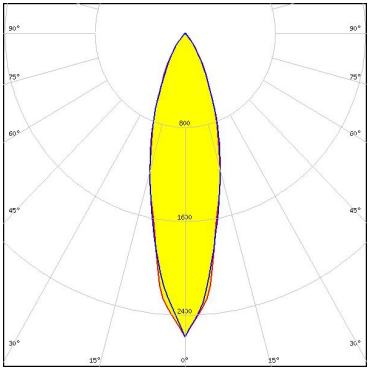
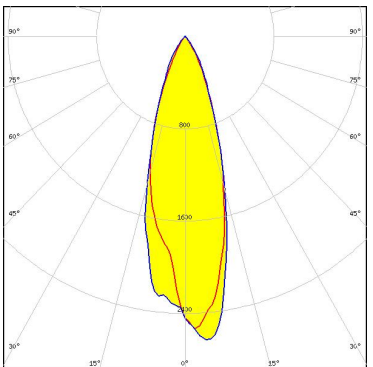
<p> <b>SEOUL SEMICONDUCTOR</b></p> <p>LED: Z8Y22P            FWHM / FWTM: 28.0°            Efficiency: 91 %            Peak intensity: 2.6 cd/lm            LEDs/each optic: 1            Light colour: White            Required components:</p>	
<p><b>SHARP</b></p> <p>LED: Double Dome (GM2BB)            FWHM / FWTM: 28.9° / 59.3°            Efficiency: 89 %            Peak intensity: 2.7 cd/lm            LEDs/each optic: 1            Light colour: White            Required components:</p>	

### GENERAL INFORMATION:

NOTE: The typical beam angle will be changed by different color, chip size and chip position tolerance. The typical total beam angle is the full angle measured where the luminous intensity is half of the peak value.

### MATERIALS:

As part of our continuous research and improvement processes, and to ensure the best possible quality and availability of our products, LEDiL reserves the right to change material grades without notice.

### PRODUCT DATA USER AGREEMENT AND DISCLAIMER:

The measured data in the provided downloadable LEDiL Product Datasheets and Mechanical 2D-Drawings is rounded and provided as reference for planning. LEDiL Oy's optical specifications have been verified by conducting performance testing of the products in accordance with the company's quality system. The reported data are averaged results of multiple measurements with typical variation. LEDiL Oy reserves the right to without prior notification make changes and improvements to its products.

LEDiL Oy assumes neither warranty, nor guarantee nor any other liability of any kind for the contents and correctness of the provided data. The provided data has been generated with highest diligence but the provided data may in reality not represent the complete possible variation range of all intrinsic parameters. Therefore, in certain cases a deviation from the provided data could occur.

LEDiL Oy reserves the right to undertake technical changes of its products without further notification which could lead to changes in the provided data. LEDiL Oy assumes no liability of any kind for the possible deviation from any provided data or any other damage resulting from the usage of the provided data.

The user agrees to this disclaimer and user agreement with the download or usage of the provided files.

#### LEDiL Oy

Joensuunkatu 13  
FI-24240 SALO  
Finland

#### LEDiL Inc.

228 West Page Street  
Suite D  
Sycamore IL 60178  
USA

#### Ledil Optics Technology (Shenzhen) Co., Ltd.

# 405 , Block B  
Casic Motor Building  
Shenzhen 518057  
P.R.CHINA

#### Local sales and technical support

[www.ledil.com/  
where\\_to\\_buy](http://www.ledil.com/where_to_buy)

#### Shipping locations

Salo, Finland  
Hong Kong, China

#### Distribution Partners

[www.ledil.com/  
where\\_to\\_buy](http://www.ledil.com/where_to_buy)