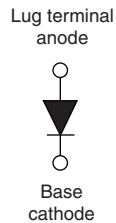

## High Performance Schottky Rectifier, 120 A

**HALF-PAK (D-67)**

### FEATURES

- 150 °C T<sub>J</sub> operation
- Low forward voltage drop
- High frequency operation
- Guard ring for enhanced ruggedness and long term reliability
- Designed and qualified for industrial level
- UL approved file E222165
- Material categorization: for definitions of compliance please see [www.vishay.com/doc?99912](http://www.vishay.com/doc?99912)

**RoHS**  
COMPLIANT

### PRIMARY CHARACTERISTICS

I <sub>F(AV)</sub>	120 A
V <sub>R</sub>	30 V
Package	HALF-PAK (D-67)
Circuit configuration	Single diode

### DESCRIPTION

The VS-122NQ.. high current Schottky rectifier module series has been optimized for low reverse leakage at high temperature. The proprietary barrier technology allows for reliable operation up to 175 °C junction temperature. Typical applications are in high current switching power supplies, plating power supplies, UPS systems, converters, freewheeling diodes, welding, and reverse battery protection.

### MAJOR RATINGS AND CHARACTERISTICS

SYMBOL	CHARACTERISTICS	VALUES	UNITS
I <sub>F(AV)</sub>	Rectangular waveform	120	A
V <sub>R(RRM)</sub>		30	V
I <sub>F(SM)</sub>	t <sub>p</sub> = 5 μs sine	18 000	A
V <sub>F</sub>	120 A <sub>pk</sub> , T <sub>J</sub> = 125 °C	0.47	V
T <sub>J</sub>	Range	-55 to +150	°C

### VOLTAGE RATINGS

PARAMETER	SYMBOL	VS-122NQ030PbF	UNITS
Maximum DC reverse voltage	V <sub>R</sub>	30	V
Maximum working peak reverse voltage	V <sub>R(WM)</sub>		

### ABSOLUTE MAXIMUM RATINGS

PARAMETER	SYMBOL	TEST CONDITIONS	VALUES	UNITS
Maximum average forward current See fig. 5	I <sub>F(AV)</sub>	50 % duty cycle at T <sub>C</sub> = 115 °C, rectangular waveform	120	A
Maximum peak one cycle non-repetitive surge current See fig. 7	I <sub>F(SM)</sub>	5 μs sine or 3 μs rect. pulse	18 000	A
		10 ms sine or 6 ms rect. pulse	2000	
Non-repetitive avalanche energy	E <sub>AS</sub>	T <sub>J</sub> = 25 °C, I <sub>AS</sub> = 11 A, L = 1 mH	54	mJ
Repetitive avalanche current	I <sub>AR</sub>	Current decaying linearly to zero in 1 μs Frequency limited by T <sub>J</sub> maximum V <sub>A</sub> = 1.5 x V <sub>R</sub> typical	12	A



ELECTRICAL SPECIFICATIONS					
PARAMETER	SYMBOL	TEST CONDITIONS		VALUES	UNITS
Maximum forward voltage drop per leg See fig. 1	$V_{FM}^{(1)}$	120 A	$T_J = 25\text{ }^\circ\text{C}$	0.57	V
		240 A		0.75	
		120 A	$T_J = 125\text{ }^\circ\text{C}$	0.47	
		240 A		0.67	
Maximum reverse leakage current per leg See fig. 2	$I_{RM}^{(1)}$	$T_J = 25\text{ }^\circ\text{C}$	$V_R = \text{Rated } V_R$	10	mA
		$T_J = 125\text{ }^\circ\text{C}$		560	
Maximum junction capacitance	$C_T$	$V_R = 5 V_{DC}$ (test signal range 100 kHz to 1 MHz) $25\text{ }^\circ\text{C}$		7400	pF
Typical series inductance	$L_S$	From top of terminal hole to mounting plane		7.0	nH
Maximum voltage rate of change	dV/dt	Rated $V_R$		10 000	V/ $\mu$ s

**Note**

(1) Pulse width < 300  $\mu$ s, duty cycle < 2 %

THERMAL - MECHANICAL SPECIFICATIONS					
PARAMETER	SYMBOL	TEST CONDITIONS	VALUES	UNITS	
Maximum junction and storage temperature range	$T_J, T_{Stg}$		-55 to 150	$^\circ\text{C}$	
Maximum thermal resistance, junction to case	$R_{thJC}$	DC operation See fig. 4	0.38	$^\circ\text{C}/\text{W}$	
Typical thermal resistance, case to heatsink	$R_{thCS}$	Mounting surface, smooth and greased	0.05		
Approximate weight			30	g	
			1.06	oz.	
Mounting torque	minimum	Non-lubricated threads	3 (26.5)	N · m (lbf · in)	
	maximum		4 (35.4)		
Terminal torque	minimum		3.4 (30)		
	maximum		5 (44.2)		
Case style					HALF-PAK module

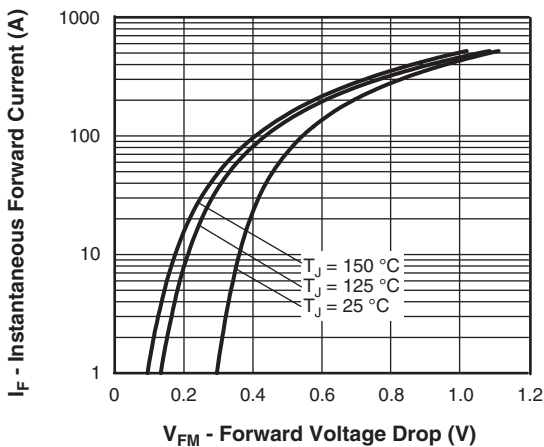

Fig. 1 - Maximum Forward Voltage Drop Characteristics

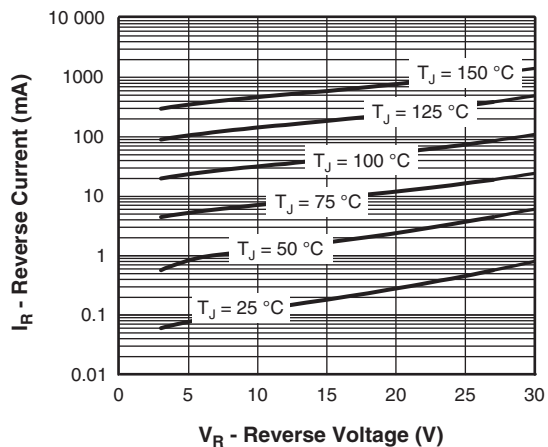

Fig. 2 - Typical Values of Reverse Current vs. Reverse Voltage

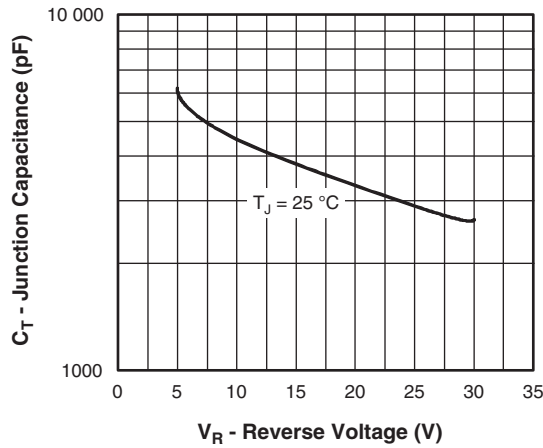

Fig. 3 - Typical Junction Capacitance vs. Reverse Voltage

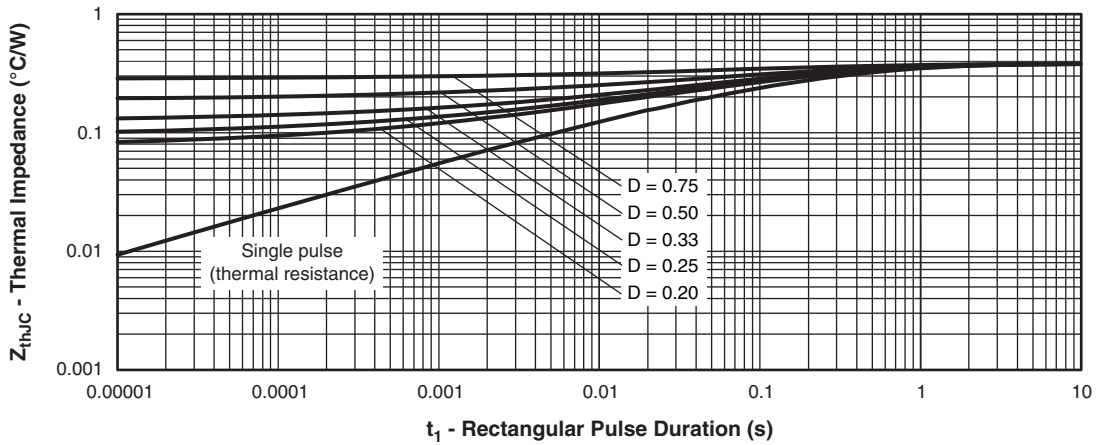

Fig. 4 - Maximum Thermal Impedance  $Z_{thJC}$  Characteristics

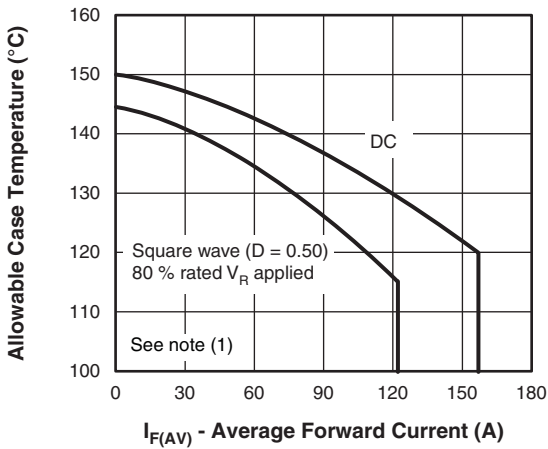

Fig. 5 - Maximum Allowable Case Temperature vs. Average Forward Current

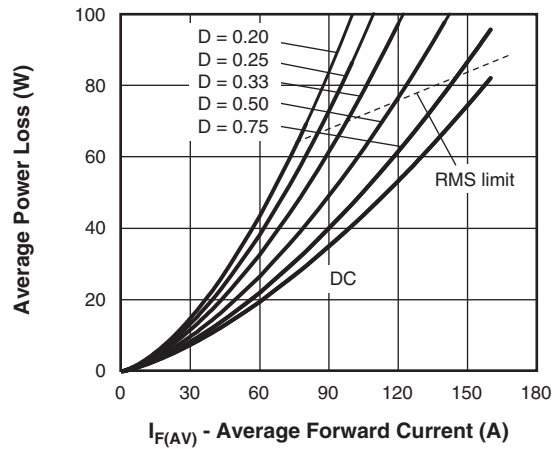

Fig. 6 - Forward Power Loss Characteristics

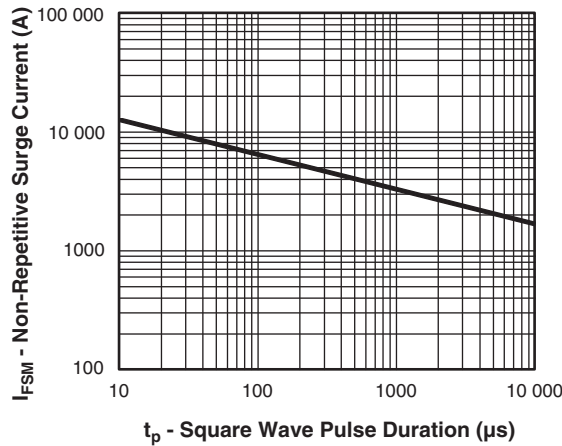

Fig. 7 - Maximum Non-Repetitive Surge Current

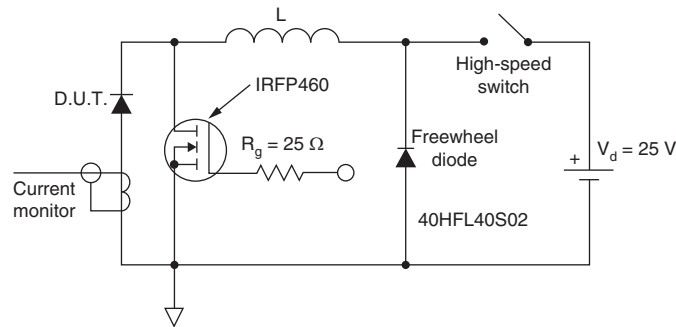

Fig. 8 - Unclamped Inductive Test Circuit

**Note**

- (1) Formula used:  $T_C = T_J - (P_d + P_{dREV}) \times R_{thJC}$ ;
- $P_d$  = Forward power loss =  $I_{F(AV)} \times V_{FM}$  at  $(I_{F(AV)}/D)$  (see fig. 6);
- $P_{dREV}$  = inverse power loss =  $V_{R1} \times I_R (1 - D)$ ;  $I_R$  at  $V_{R1}$  = rated  $V_R$

**ORDERING INFORMATION TABLE**

Device code	<b>VS-</b>	<b>12</b>	<b>2</b>	<b>N</b>	<b>Q</b>	<b>030</b>	<b>PbF</b>
	①	②	③	④	⑤	⑥	⑦
	<b>1</b>	-	Vishay Semiconductors product				
	<b>2</b>	-	Average current rating (x 10)				
	<b>3</b>	-	Product silicon identification				
	<b>4</b>	-	N = not isolated				
	<b>5</b>	-	Q = Schottky rectifier diode				
	<b>6</b>	-	Voltage rating (030 = 30 V)				
	<b>7</b>	-	Lead (Pb)-free				

LINKS TO RELATED DOCUMENTS	
Dimensions	<a href="http://www.vishay.com/doc?95020">www.vishay.com/doc?95020</a>

## D-67 HALF-PAK

**DIMENSIONS** in millimeters (inches)

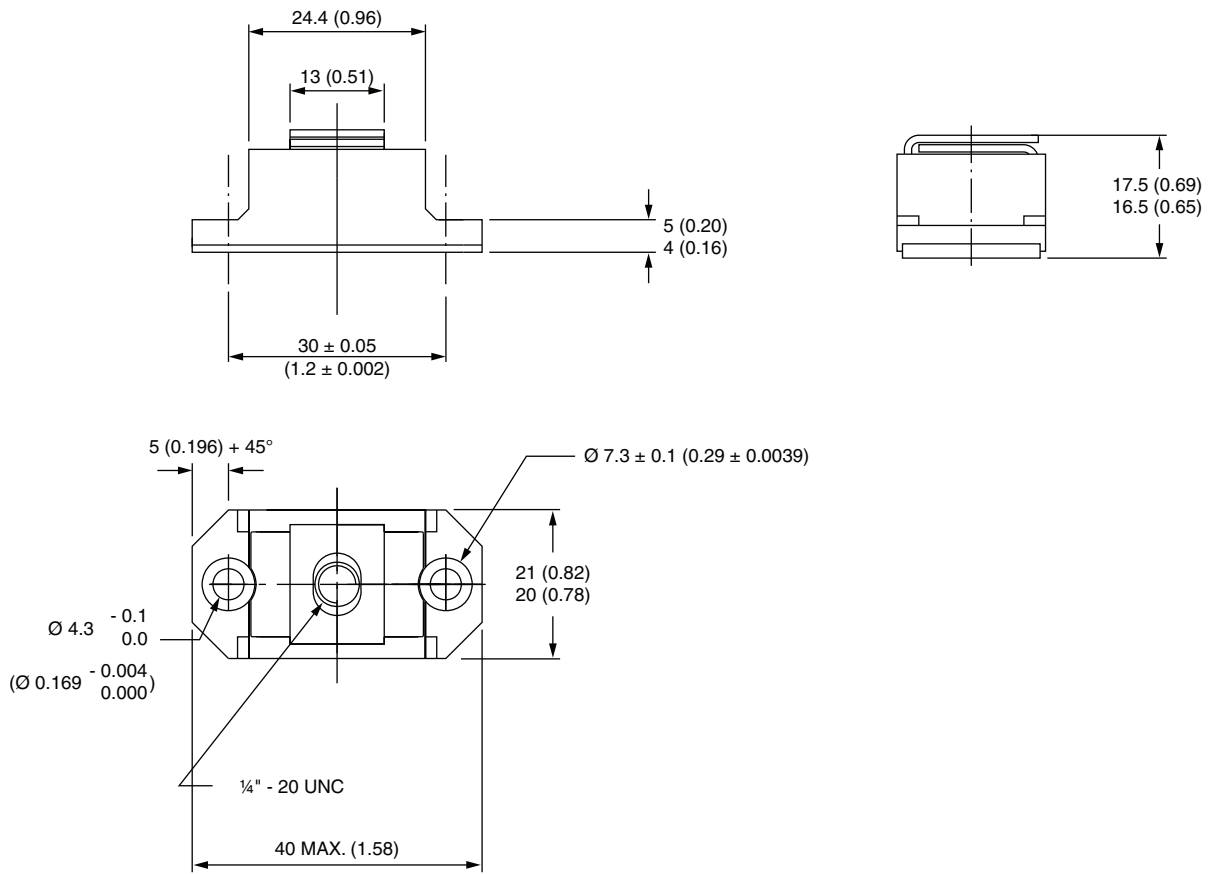



## Disclaimer

ALL PRODUCT, PRODUCT SPECIFICATIONS AND DATA ARE SUBJECT TO CHANGE WITHOUT NOTICE TO IMPROVE RELIABILITY, FUNCTION OR DESIGN OR OTHERWISE.

Vishay Intertechnology, Inc., its affiliates, agents, and employees, and all persons acting on its or their behalf (collectively, "Vishay"), disclaim any and all liability for any errors, inaccuracies or incompleteness contained in any datasheet or in any other disclosure relating to any product.

Vishay makes no warranty, representation or guarantee regarding the suitability of the products for any particular purpose or the continuing production of any product. To the maximum extent permitted by applicable law, Vishay disclaims (i) any and all liability arising out of the application or use of any product, (ii) any and all liability, including without limitation special, consequential or incidental damages, and (iii) any and all implied warranties, including warranties of fitness for particular purpose, non-infringement and merchantability.

Statements regarding the suitability of products for certain types of applications are based on Vishay's knowledge of typical requirements that are often placed on Vishay products in generic applications. Such statements are not binding statements about the suitability of products for a particular application. It is the customer's responsibility to validate that a particular product with the properties described in the product specification is suitable for use in a particular application. Parameters provided in datasheets and / or specifications may vary in different applications and performance may vary over time. All operating parameters, including typical parameters, must be validated for each customer application by the customer's technical experts. Product specifications do not expand or otherwise modify Vishay's terms and conditions of purchase, including but not limited to the warranty expressed therein.

Hyperlinks included in this datasheet may direct users to third-party websites. These links are provided as a convenience and for informational purposes only. Inclusion of these hyperlinks does not constitute an endorsement or an approval by Vishay of any of the products, services or opinions of the corporation, organization or individual associated with the third-party website. Vishay disclaims any and all liability and bears no responsibility for the accuracy, legality or content of the third-party website or for that of subsequent links.

Except as expressly indicated in writing, Vishay products are not designed for use in medical, life-saving, or life-sustaining applications or for any other application in which the failure of the Vishay product could result in personal injury or death. Customers using or selling Vishay products not expressly indicated for use in such applications do so at their own risk. Please contact authorized Vishay personnel to obtain written terms and conditions regarding products designed for such applications.

No license, express or implied, by estoppel or otherwise, to any intellectual property rights is granted by this document or by any conduct of Vishay. Product names and markings noted herein may be trademarks of their respective owners.