

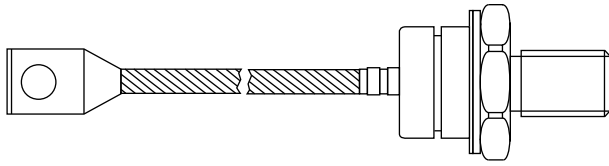

Standard Recovery Diodes, (Stud Version), 200 A



DO-30 (DO-205AC)

FEATURES

- Wide current range
- High voltage ratings up to 2400 V
- High surge current capabilities
- Stud cathode and stud anode version
- Standard JEDEC® types
- Compression bonded encapsulations
- Designed and qualified for industrial level
- Material categorization: for definitions of compliance please see www.vishay.com/doc?99912



TYPICAL APPLICATIONS

- Converters
- Power supplies
- Machine tool controls
- High power drives
- Medium traction applications

PRIMARY CHARACTERISTICS	
$I_{F(AV)}$	200 A
Package	DO-30 (DO-205AC)
Circuit configuration	Single

MAJOR RATINGS AND CHARACTERISTICS				
PARAMETER	TEST CONDITIONS	VS-SD200N/R		UNITS
		1600 to 2000	2400	
$I_{F(AV)}$		200	200	A
	T_C	110	110	°C
$I_{F(RMS)}$		314	314	A
I_{FSM}	50 Hz	4700	4700	
	60 Hz	4920	4920	
I^2t	50 Hz	110	110	kA ² s
	60 Hz	101	101	
V_{RRM}	Range	1600 to 2000	2400	V
T_J		-40 to +180	+150	°C

ELECTRICAL SPECIFICATIONS

VOLTAGE RATINGS				
TYPE NUMBER	VOLTAGE CODE	V_{RRM} , MAXIMUM REPETITIVE PEAK REVERSE VOLTAGE V	V_{RSM} , MAXIMUM NON-REPETITIVE PEAK REVERSE VOLTAGE V	I_{RRM} MAXIMUM AT $T_J = T_J$ MAXIMUM mA
VS-SD200N/R	16	1600	1700	15
	20	2000	2100	
	24	2400	2500	



FORWARD CONDUCTION					
PARAMETER	SYMBOL	TEST CONDITIONS		VALUES	UNITS
Maximum average forward current at case temperature	I _{F(AV)}	180° conduction, half sine wave		200	A
Maximum average forward current at case temperature				110	°C
Maximum average forward current at case temperature	I _{F(AV)}	180° conduction, half sine wave		220	A
Maximum average forward current at case temperature				100	°C
Maximum RMS forward current	I _{F(RMS)}	DC at 95 °C case temperature		314	A
Maximum peak, one-cycle forward, non-repetitive surge current	I _{FSM}	t = 10 ms	No voltage reapplied	4700	
		t = 8.3 ms	No voltage reapplied	4920	
		t = 10 ms	100 % V _{RRM} reapplied	3950	
		t = 8.3 ms	100 % V _{RRM} reapplied	4140	
Maximum I ² t for fusing	I ² t	t = 10 ms	No voltage reapplied	110	kA ² s
		t = 8.3 ms	No voltage reapplied	101	
		t = 10 ms	100 % V _{RRM} reapplied	78	
		t = 8.3 ms	100 % V _{RRM} reapplied	71	
Maximum I ² Öt for fusing	I ² Öt	t = 0.1 to 10 ms, no voltage reapplied		1100	kA ² Ös
Low level value of threshold voltage	V _{F(TO)1}	(16.7 % × π × I _{F(AV)} < I < π × I _{F(AV)}), T _J = T _J maximum		0.90	V
High level value of threshold voltage	V _{F(TO)2}	(I > π × I _{F(AV)}), T _J = T _J maximum		1.00	
Low level value of forward slope resistance	r _{f1}	(16.7 % × π × I _{F(AV)} < I < π × I _{F(AV)}), T _J = T _J maximum		0.79	mW
High level value of forward slope resistance	r _{f2}	(I > π × I _{F(AV)}), T _J = T _J maximum		0.64	
Maximum forward voltage drop	V _{FM}	I _{pk} = 630 A, T _J = T _J maximum, t _p = 10 ms sinusoidal wave		1.40	V

THERMAL AND MECHANICAL SPECIFICATIONS					
PARAMETER	SYMBOL	TEST CONDITIONS	SD200N/R		UNITS
			1600 to 2000	2400	
Maximum junction operating temperature range	T _J		-40 to 180	-40 to 150	°C
Maximum storage temperature range	T _{Stg}		-55 to 200		
Maximum thermal resistance, junction to case	R _{thJC}	DC operation	0.23		K/W
Maximum thermal resistance, case to heatsink	R _{thCS}	Mounting surface, smooth, flat and greased	0.08		
Maximum allowed mounting torque ± 10 %		Not-lubricated threads	14		Nm
Approximate weight			120		g
Case style		See dimensions (link at the end of datasheet)	DO-30 (DO-205AC)		

ΔR_{thJC} CONDUCTION				
CONDUCTION ANGLE	SINUSOIDAL CONDUCTION	RECTANGULAR CONDUCTION	TEST CONDITIONS	UNITS
180°	0.041	0.030	T _J = T _J maximum	K/W
120°	0.049	0.051		
90°	0.063	0.068		
60°	0.093	0.096		
30°	0.156	0.157		

Note

- The table above shows the increment of thermal resistance R_{thJC} when devices operate at different conduction angles than DC

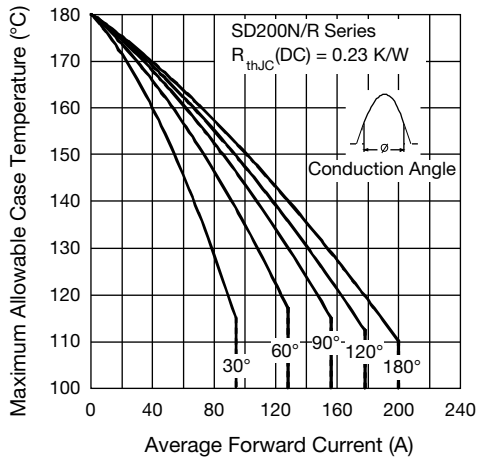

Fig. 1 - Current Ratings Characteristics

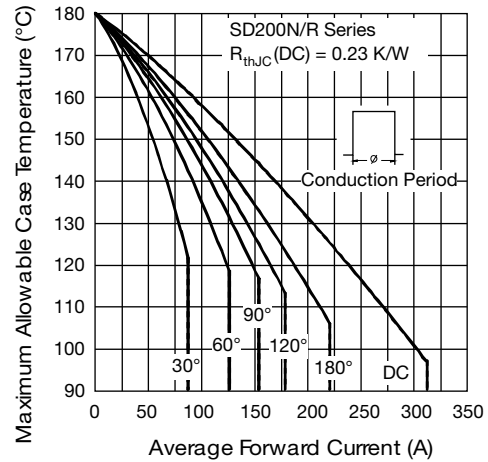

Fig. 2 - Current Ratings Characteristics

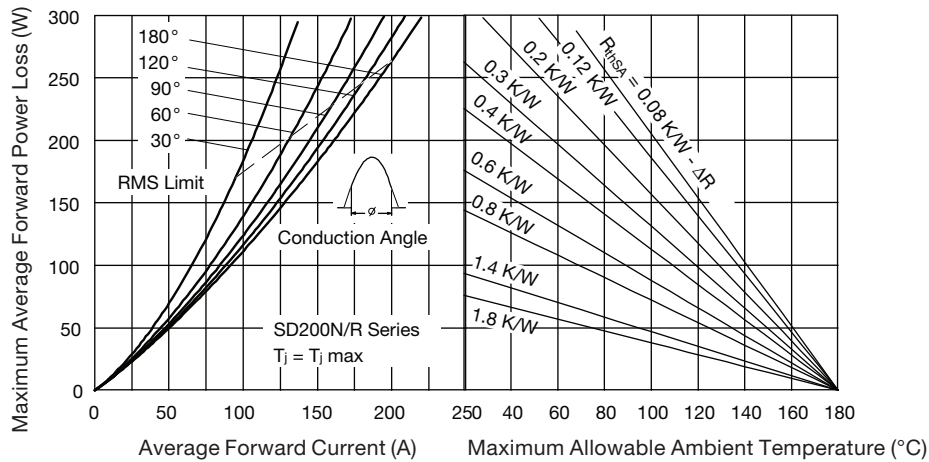

Fig. 3 - Forward Power Loss Characteristics

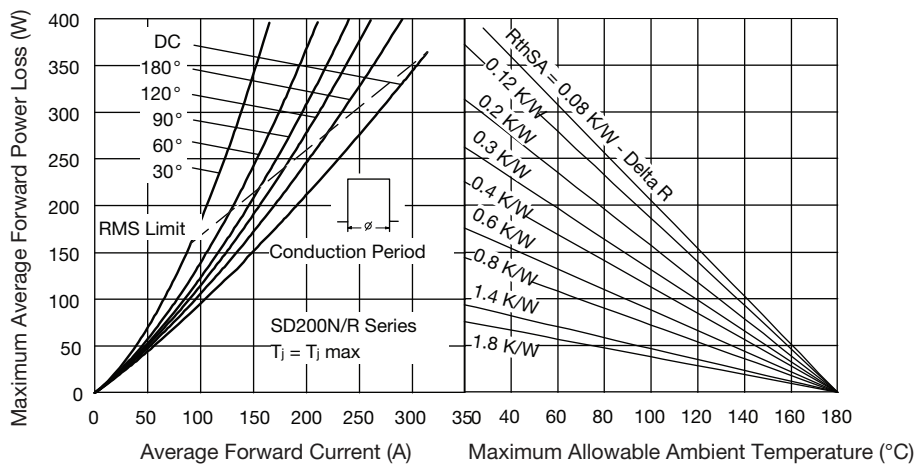

Fig. 4 - Forward Power Loss Characteristics

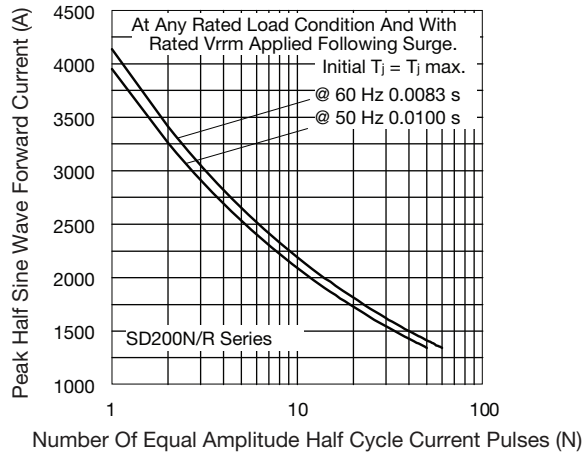

Fig. 5 - Maximum Non-Repetitive Surge Current

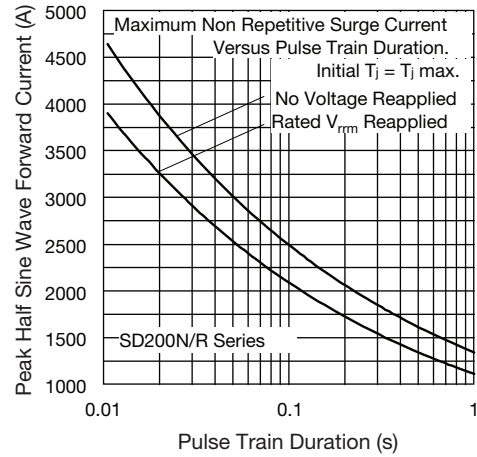

Fig. 6 - Maximum Non-Repetitive Surge Current

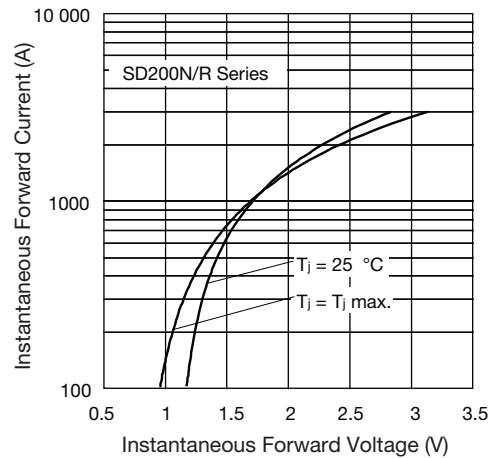

Fig. 7 - Forward Voltage Drop Characteristics

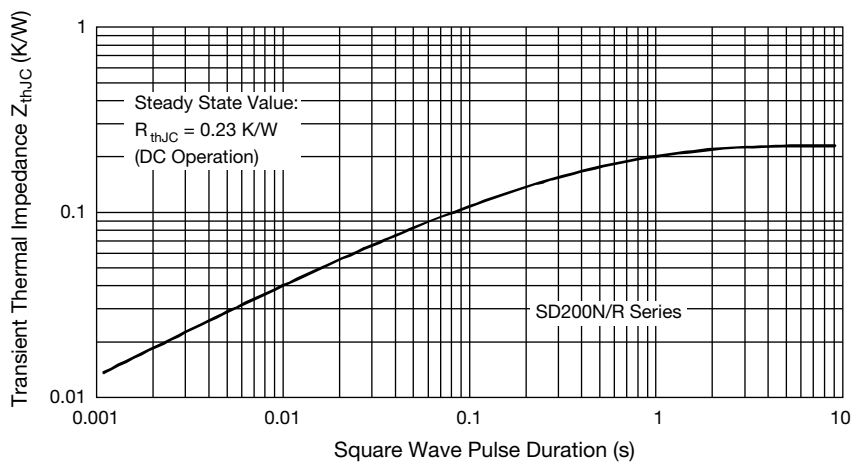

Fig. 8 - Thermal Impedance Z_{thJC} Characteristic



ORDERING INFORMATION TABLE

Device code	VS-	SD	20	0	N	24	P	C
	①	②	③	④	⑤	⑥	⑦	⑧

- 1** - Vishay Semiconductors product
- 2** - Diode
- 3** - Essential part number
- 4** - 0 = standard recovery
- 5** -
 - N = stud normal polarity (cathode to stud)
 - R = stud reverse polarity (anode to stud)
- 6** - Voltage code x 100 = V_{RRM} (see Voltage Ratings table)
- 7** -
 - P = stud base DO-30 (DO-205AC) 1/2" 20UNF-2A
 - M = stud base DO-30 (DO-205AC) M12 x 1.75
- 8** - C = ceramic housing

For metric device M12 x 1.75 contact factory

LINKS TO RELATED DOCUMENTS	
Dimensions	www.vishay.com/doc?95302

DO-205AC (DO-30)

DIMENSIONS in millimeters (inches)

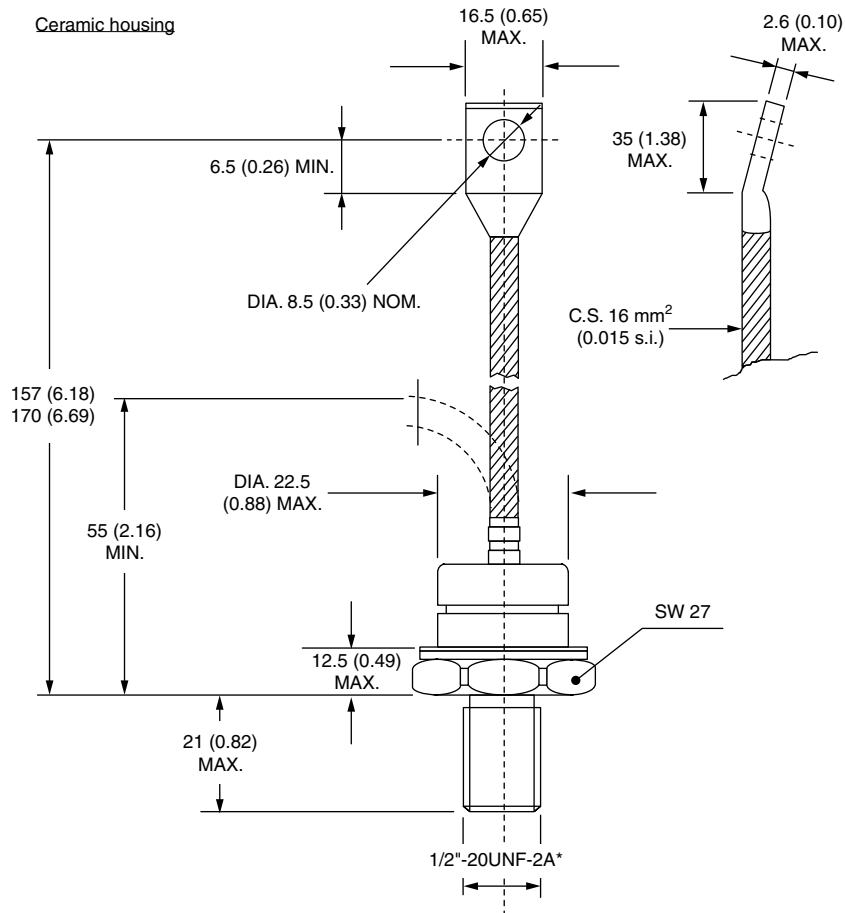

*For metric device: M12 x 1.75 contact factory



Disclaimer

ALL PRODUCT, PRODUCT SPECIFICATIONS AND DATA ARE SUBJECT TO CHANGE WITHOUT NOTICE TO IMPROVE RELIABILITY, FUNCTION OR DESIGN OR OTHERWISE.

Vishay Intertechnology, Inc., its affiliates, agents, and employees, and all persons acting on its or their behalf (collectively, "Vishay"), disclaim any and all liability for any errors, inaccuracies or incompleteness contained in any datasheet or in any other disclosure relating to any product.

Vishay makes no warranty, representation or guarantee regarding the suitability of the products for any particular purpose or the continuing production of any product. To the maximum extent permitted by applicable law, Vishay disclaims (i) any and all liability arising out of the application or use of any product, (ii) any and all liability, including without limitation special, consequential or incidental damages, and (iii) any and all implied warranties, including warranties of fitness for particular purpose, non-infringement and merchantability.

Statements regarding the suitability of products for certain types of applications are based on Vishay's knowledge of typical requirements that are often placed on Vishay products in generic applications. Such statements are not binding statements about the suitability of products for a particular application. It is the customer's responsibility to validate that a particular product with the properties described in the product specification is suitable for use in a particular application. Parameters provided in datasheets and / or specifications may vary in different applications and performance may vary over time. All operating parameters, including typical parameters, must be validated for each customer application by the customer's technical experts. Product specifications do not expand or otherwise modify Vishay's terms and conditions of purchase, including but not limited to the warranty expressed therein.

Hyperlinks included in this datasheet may direct users to third-party websites. These links are provided as a convenience and for informational purposes only. Inclusion of these hyperlinks does not constitute an endorsement or an approval by Vishay of any of the products, services or opinions of the corporation, organization or individual associated with the third-party website. Vishay disclaims any and all liability and bears no responsibility for the accuracy, legality or content of the third-party website or for that of subsequent links.

Except as expressly indicated in writing, Vishay products are not designed for use in medical, life-saving, or life-sustaining applications or for any other application in which the failure of the Vishay product could result in personal injury or death. Customers using or selling Vishay products not expressly indicated for use in such applications do so at their own risk. Please contact authorized Vishay personnel to obtain written terms and conditions regarding products designed for such applications.

No license, express or implied, by estoppel or otherwise, to any intellectual property rights is granted by this document or by any conduct of Vishay. Product names and markings noted herein may be trademarks of their respective owners.