



## Technical Data Sheet

### 5mm Infrared LED , T-1 3/4

#### IR1503

#### Features

- High reliability
- High radiant intensity
- Peak wavelength  $\lambda_p=940\text{nm}$
- 2.54mm Lead spacing
- Low forward voltage
- Pb Free
- This product itself will remain within RoHS compliant version.

#### Descriptions

- EVERLIGHT's Infrared Emitting Diode (IR1503) is a high intensity diode , molded in a blue plastic package.
- The device is spectrally matched with phototransistor , photodiode and infrared receiver module.



#### Applications

- Free air transmission system
- Infrared remote control units with high power requirement
- Smoke detector
- Infrared applied system

#### Device Selection Guide

| LED Part No. | Chip     | Lens Color |
|--------------|----------|------------|
|              | Material |            |
| IR1503       | GaAlAs   | Blue       |

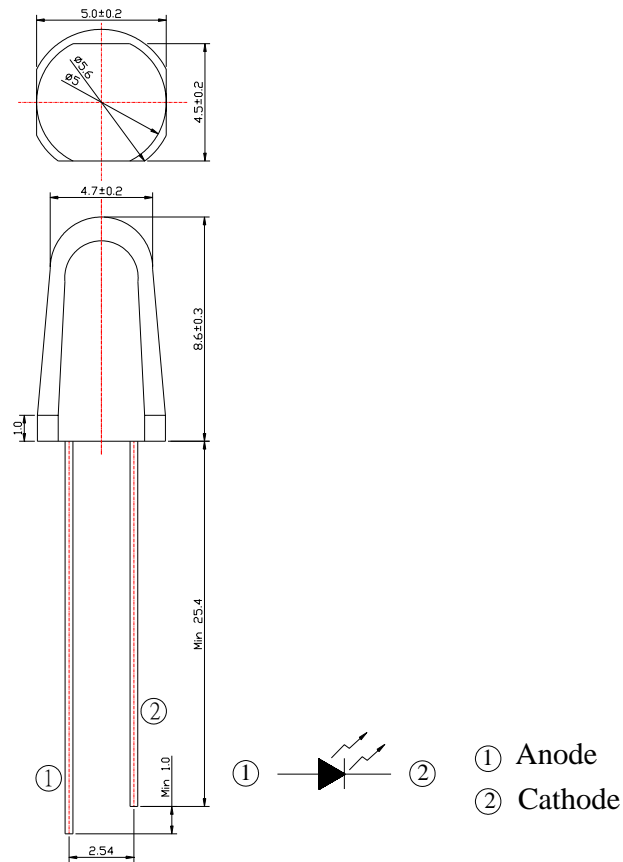
**Package Dimensions**

- Notes:** 1.All dimensions are in millimeters  
2.Tolerances unless dimensions  $\pm 0.25\text{mm}$

**Absolute Maximum Ratings (Ta=25°C)**

| Parameter   | Symbol    | Rating    | Units |
|---|-----------|-----------|-------|
| Continuous Forward Current                                  | $I_F$     | 100       | mA    |
| Peak Forward Current(*1)                                    | $I_{FP}$  | 1.0       | A     |
| Reverse Voltage   | $V_R$     | 5         | V     |
| Operating Temperature                                       | $T_{opr}$ | -40 ~ +85 | °C    |
| Storage Temperature   | $T_{stg}$ | -40 ~ +85 | °C    |
| Soldering Temperature(*2)                                   | $T_{sol}$ | 260       | °C    |
| Power Dissipation at(or below)<br>25°C Free Air Temperature | $P_d$     | 120       | mW    |

**Notes:** \*1: $I_{FP}$  Conditions--Pulse Width  $\leq 100 \mu s$  and Duty  $\leq 1\%$ .

\*2:Soldering time  $\leq 5$  seconds.

**Electro-Optical Characteristics (Ta=25°C)**

| Parameter          | Symbol            | Condition  | Min. | Typ. | Max. | Units |
|--------------------|-------------------|--|------|------|------|-------|
| Radiant Intensity  | Ee                | I <sub>F</sub> =20mA                                     | 21   | 28   | --   | mW/sr |
|                    |                   | I <sub>F</sub> =100mA<br>Pulse Width ≤ 100 μs ,Duty ≤ 1% | --   | 120  | --   |       |
|                    |                   | I <sub>F</sub> =1A<br>Pulse Width ≤ 100 μs ,Duty ≤ 1%.   | --   | 1000 | --   |       |
| Peak Wavelength    | λ <sub>p</sub>    | I <sub>F</sub> =20mA                                     | --   | 940  | --   | nm    |
| Spectral Bandwidth | Δλ                | I <sub>F</sub> =20mA                                     | --   | 80   | --   | nm    |
| Forward Voltage    | V <sub>F</sub>    | I <sub>F</sub> =20mA                                     |      | 1.2  | 1.5  | V     |
|                    |                   | I <sub>F</sub> =100mA<br>Pulse Width ≤ 100 μs ,Duty ≤ 1% | --   | 1.4  | 1.85 |       |
|                    |                   | I <sub>F</sub> =1A<br>Pulse Width ≤ 100 μs ,Duty ≤ 1%.   | --   | 2.6  | 4.0  |       |
| Reverse Current    | I <sub>R</sub>    | V <sub>R</sub> =5V                                       | --   | --   | 10   | μA    |
| View Angle         | 2θ <sub>1/2</sub> | I <sub>F</sub> =20mA                                     | --   | 20   | --   | deg   |

**Rank**

 Condition : I<sub>F</sub>=20mA

Unit : mW/sr

| Bin Number | Q    | R    | S    |
|------------|------|------|------|
| Min        | 21.0 | 30.0 | 42.0 |
| Max        | 34.0 | 48.0 | 67.0 |

**Typical Electro-Optical Characteristics Curves**

Fig.1 Forward Current vs.

Ambient Temperature

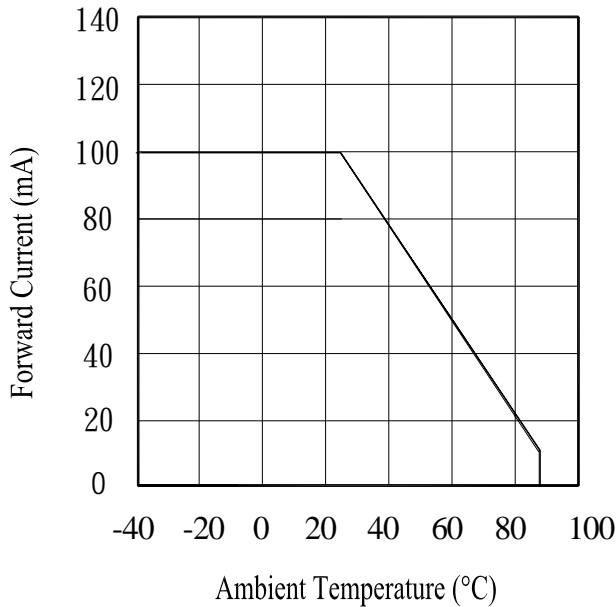

Fig.2 Spectral Distribution

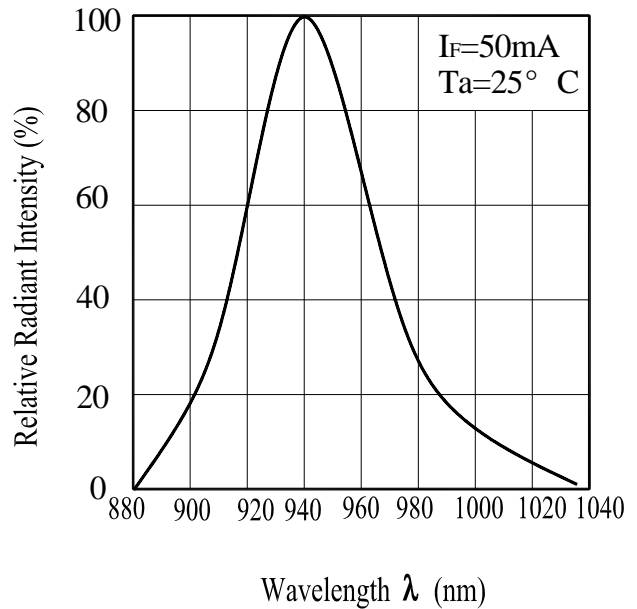

Fig.3 Peak Emission Wavelength

Ambient Temperature

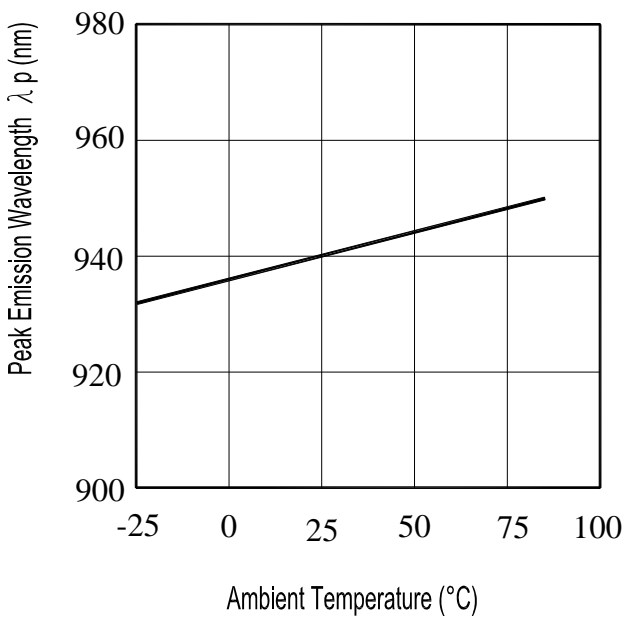
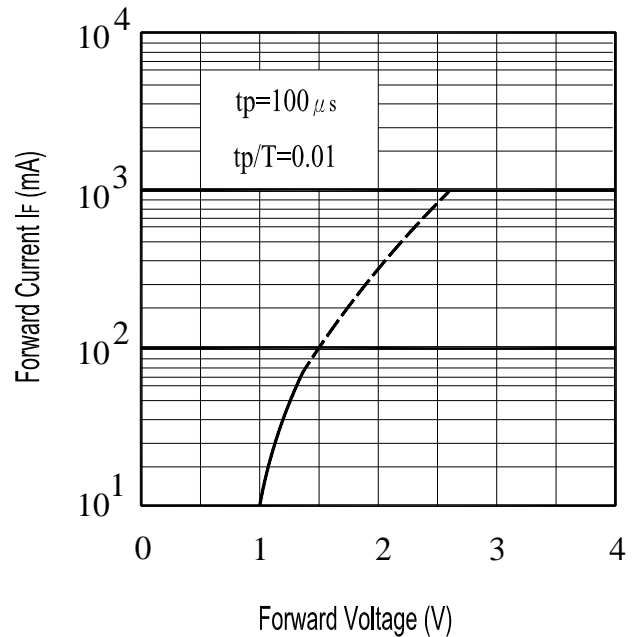

Fig.4 Forward Current vs. Forward Voltage



**Typical Electro-Optical Characteristics Curves**

Fig.5 Relative Intensity vs.

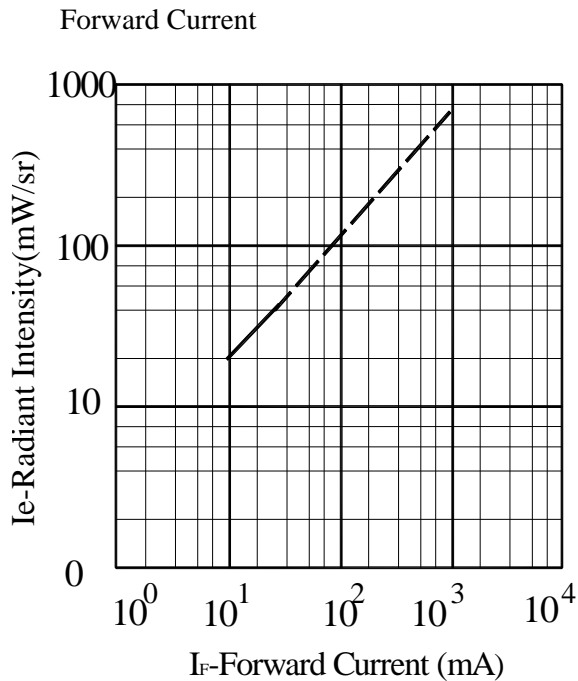

Fig.6 Relative Radiant Intensity vs.

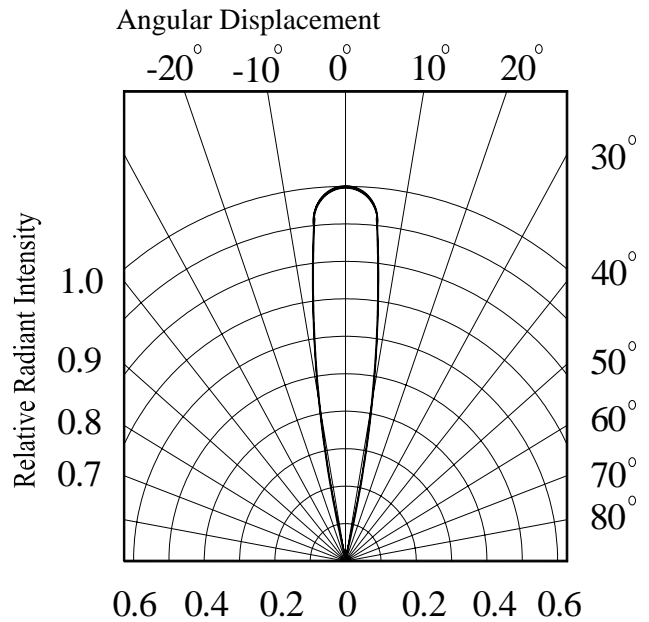

Fig.7 Relative Intensity vs.

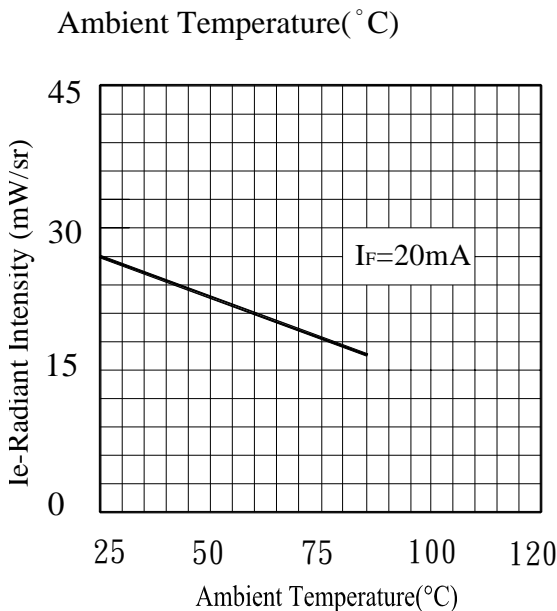
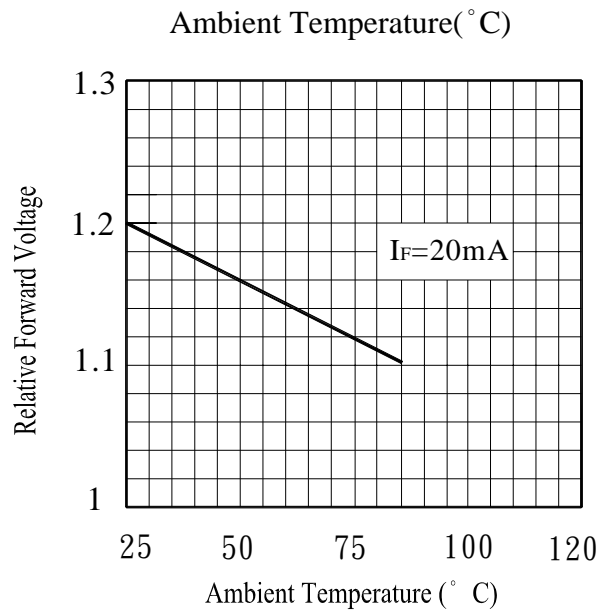

Fig.8 Forward Current vs.



**Reliability Test Item And Condition**

The reliability of products shall be satisfied with items listed below.

Confidence level : 90%





LTPD : 10%

| NO. | Item                               | Test Conditions   | Test Hours/<br>Cycles | Sample<br>Sizes | Failure<br>Judgement<br>Criteria  | Ac/Re |
|-----|------------------------------------|---|-----------------------|-----------------|---|-------|
| 1   | Solder Heat                        | TEMP. : $260^{\circ}\text{C} \pm 5^{\circ}\text{C}$   | 10secs                | 22pcs           | $I_R \geq U \times 2$<br>$E_e \leq L \times 0.8$<br>$V_F \geq U \times 1.2$<br><br>U : Upper<br>Specification<br><br>Limit<br>L : Lower<br>Specification<br>Limit | 0/1   |
| 2   | Temperature Cycle                  | H : $+100^{\circ}\text{C}$ 15mins<br>$\updownarrow$ 5mins<br>L : $-40^{\circ}\text{C}$ 15mins | 300Cycles             | 22pcs           |   | 0/1   |
| 3   | Thermal Shock                      | H : $+100^{\circ}\text{C}$ 5mins<br>$\updownarrow$ 10secs<br>L : $-10^{\circ}\text{C}$ 5mins  | 300Cycles             | 22pcs           |   | 0/1   |
| 4   | High Temperature Storage           | TEMP. : $+100^{\circ}\text{C}$  | 1000hrs               | 22pcs           |   | 0/1   |
| 5   | Low Temperature Storage            | TEMP. : $-40^{\circ}\text{C}$   | 1000hrs               | 22pcs           |   | 0/1   |
| 6   | DC Operating Life                  | $I_F = 20\text{mA}$   | 1000hrs               | 22pcs           |   | 0/1   |
| 7   | High Temperature/<br>High Humidity | $85^{\circ}\text{C} / 85\% \text{ R.H}$   | 1000hrs               | 22pcs           |   | 0/1   |

**Packing Quantity Specification**

1. 500PCS/1Bag,5Bag/1Box
2. 10Boxes/1Carton

**Label Form Specification**

|  |                                   |
|--|-----------------------------------|
|   | CPN: Customer's Production Number |
| CPN:   | P/N : Production Number           |
| P/N:   | QTY: Packing Quantity             |
|   | CAT: Ranks                        |
| QTY: IR1503  | HUE: Peak Wavelength              |
|   | REF: Reference                    |
| LOT NO:  | LOT No: Lot Number                |
|  |                                   |

**Notes**

1. Above specification may be changed without notice. EVERLIGHT will reserve authority on material change for above specification.
2. When using this product, please observe the absolute maximum ratings and the instructions for using outlined in these specification sheets. EVERLIGHT assumes no responsibility for any damage resulting from use of the product which does not comply with the absolute maximum ratings and the instructions included in these specification sheets.
3. These specification sheets include materials protected under copyright of EVERLIGHT corporation. Please don't reproduce or cause anyone to reproduce them without EVERLIGHT's consent.

**EVERLIGHT ELECTRONICS CO., LTD.**  
Office: No 25, Lane 76, Sec 3, Chung Yang Rd,  
Tucheng, Taipei 236, Taiwan, R.O.C

Tel: 886-2-2267-2000, 2267-9936  
Fax: 886-2267-6244, 2267-6189, 2267-6306  
<http://www.everlight.com>