

Fast Recovery Diodes (Stud Version) 200 A



DO-9 (DO-205AB)

FEATURES

- High power fast recovery diode series
- 1.0 μ s to 2.0 μ s recovery time
- High voltage ratings up to 2500 V
- High current capability
- Optimized turn-on and turn-off characteristics
- Low forward recovery
- Fast and soft reverse recovery
- Compression bonded encapsulation
- Stud version JEDEC® DO-9 (DO-205AB)
- Maximum junction temperature 125 °C
- Designed and qualified for industrial level
- Material categorization: for definitions of compliance please see www.vishay.com/doc?99912

**RoHS
COMPLIANT**

PRIMARY CHARACTERISTICS

$I_{F(AV)}$	200 A
Package	DO-9 (DO-205AB)
Circuit configuration	Single

TYPICAL APPLICATIONS

- Snubber diode for GTO
- High voltage freewheeling diode
- Fast recovery rectifier applications

MAJOR RATINGS AND CHARACTERISTICS

PARAMETER	TEST CONDITIONS	VALUES	UNITS
$I_{F(AV)}$		200	A
	T_C	85	°C
$I_{F(RMS)}$		314	A
I_{FSM}	50 Hz	4990	
	60 Hz	5230	
I^2t	50 Hz	125	kA ² s
	60 Hz	114	
V_{RRM}	Range	400 to 2500	V
t_{rr}	Range	1.0 to 2.0	μ s
	T_J	25	°C
T_J		-40 to +125	

ELECTRICAL SPECIFICATIONS

VOLTAGE RATINGS

TYPE NUMBER	VOLTAGE CODE	V_{RRM} , MAXIMUM REPETITIVE PEAK AND OFF-STATE VOLTAGE V	V_{RSM} , MAXIMUM NON-REPETITIVE PEAK VOLTAGE V	I_{RRM} MAXIMUM $T_J = 125\text{ °C}$ mA
VS-SD203N/R..S10	04	400	500	35
	08	800	900	
	10	1000	1100	
VS-SD203N/R..S15	12	1200	1300	
	14	1400	1500	
	16	1600	1700	
VS-SD203N/R..S20	20	2000	2100	
	25	2500	2600	



FORWARD CONDUCTION					
PARAMETER	SYMBOL	TEST CONDITIONS		VALUES	UNITS
Maximum average forward current at case temperature	$I_{F(AV)}$	180° conduction, half sine wave		200	A
				85	°C
Maximum RMS current	$I_{F(RMS)}$	DC at 76 °C case temperature		314	A
Maximum peak, one-cycle non-repetitive forward current	I_{FSM}	t = 10 ms	No voltage reapplied	4990	
		t = 8.3 ms		5230	
		t = 10 ms	100 % V_{RRM} reapplied	4200	
		t = 8.3 ms		4400	
Maximum I^2t for fusing	I^2t	t = 10 ms	No voltage reapplied	125	kA ² s
		t = 8.3 ms		114	
		t = 10 ms	100 % V_{RRM} reapplied	88	
		t = 8.3 ms		81	
Maximum $I^2\sqrt{t}$ for fusing	$I^2\sqrt{t}$	t = 0.1 to 10 ms, no voltage reapplied		1250	kA ² √s
Low level value of threshold voltage	$V_{F(TO)1}$	(16.7 % $\times \pi \times I_{F(AV)} < I < \pi \times I_{F(AV)}$, $T_J = T_J$ maximum)		1.00	V
High level value of threshold voltage	$V_{F(TO)2}$	(I > $\pi \times I_{F(AV)}$, $T_J = T_J$ maximum)		1.47	
Low level value of forward slope resistance	r_{f1}	(16.7 % $\times \pi \times I_{F(AV)} < I < \pi \times I_{F(AV)}$, $T_J = T_J$ maximum)		1.10	mW
High level value of forward slope resistance	r_{f2}	(I > $\pi \times I_{F(AV)}$, $T_J = T_J$ maximum)		0.46	
Maximum forward voltage drop	V_{FM}	$I_{pk} = 628$ A, $T_J = 25$ °C, $t_p = 400$ μs square pulse		1.65	V

RECOVERY CHARACTERISTICS								
CODE	MAXIMUM VALUE AT $T_J = 25$ °C	TEST CONDITIONS			TYPICAL VALUES AT $T_J = 125$ °C			
	t_{rr} at 25 % I_{RRM} (μs)	I_{pk} SQUARE PULSE (A)	di/dt (A/μs)	V_r (V)	t_{rr} at 25 % I_{RRM} (μs)	Q_{rr} (μC)	I_{rr} (A)	
S10	1.0	750	25	-30	2.4	52	33	
S15	1.5				2.9	90	44	
S20	2.0				3.2	107	46	

THERMAL AND MECHANICAL SPECIFICATIONS				
PARAMETER	SYMBOL	TEST CONDITIONS	VALUES	UNITS
Maximum operating temperature range	T_J		-40 to 125	°C
Maximum storage temperature range	T_{Stg}		-40 to 150	
Maximum thermal resistance, junction to case	R_{thJC}	DC operation	0.115	K/W
Maximum thermal resistance, case to heatsink	R_{thCS}	Mounting surface, smooth, flat and greased	0.08	
Mounting torque ± 10 %		Not-lubricated threads	31	Nm
		Lubricated threads	24.5	
Approximate weight			250	g
Case style		See dimensions (link at the end of datasheet)	DO-9 (DO-205AB)	



ΔR_{thJC} CONDUCTION				
CONDUCTION ANGLE	SINUSOIDAL CONDUCTION	RECTANGULAR CONDUCTION	TEST CONDITIONS	UNITS
180°	0.010	0.008	$T_J = T_{J \text{ maximum}}$	K/W
120°	0.013	0.014		
90°	0.017	0.019		
60°	0.025	0.027		
30°	0.044	0.044		

Note

- The table above shows the increment of thermal resistance R_{thJC} when devices operate at different conduction angles than DC

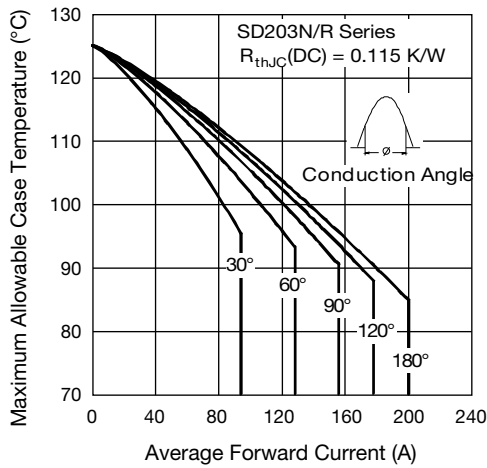

Fig. 1 - Current Ratings Characteristics

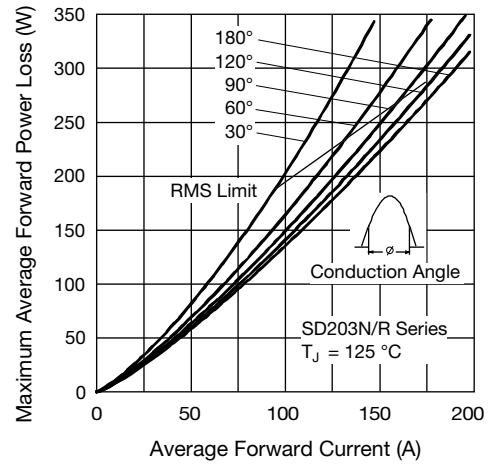

Fig. 3 - Forward Power Loss Characteristics

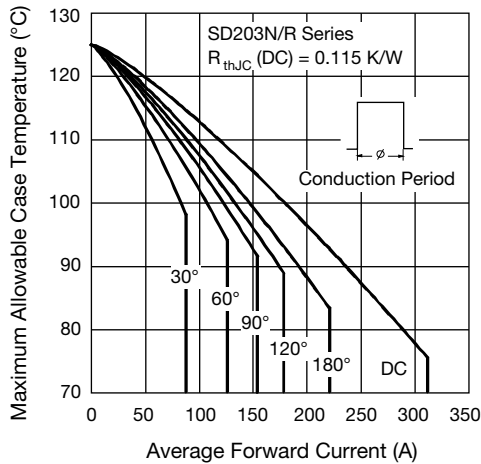

Fig. 2 - Current Ratings Characteristics

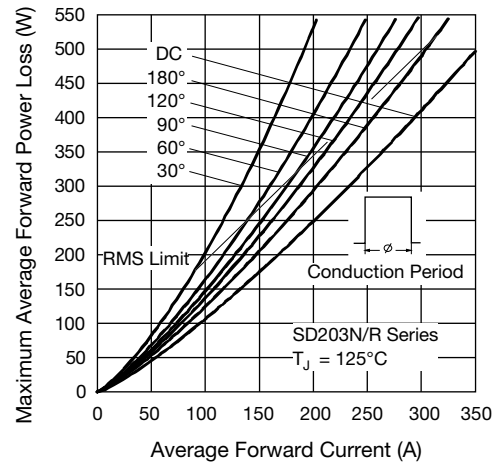

Fig. 4 - Forward Power Loss Characteristics

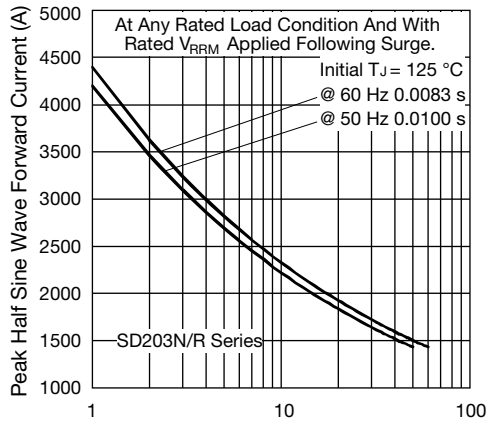

Fig. 5 - Maximum Non-Repetitive Surge Current

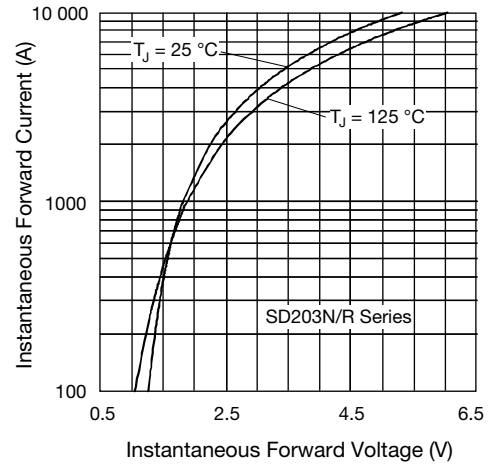

Fig. 7 - Forward Voltage Drop Characteristics

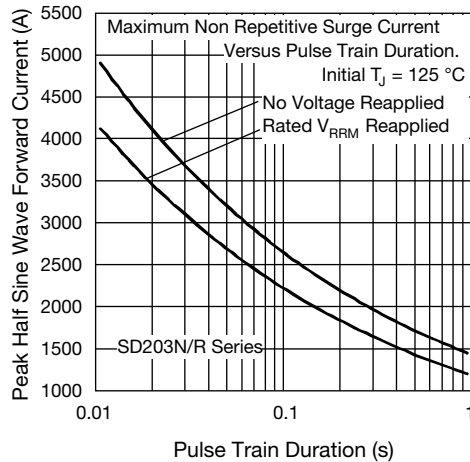

Fig. 6 - Maximum Non-Repetitive Surge Current

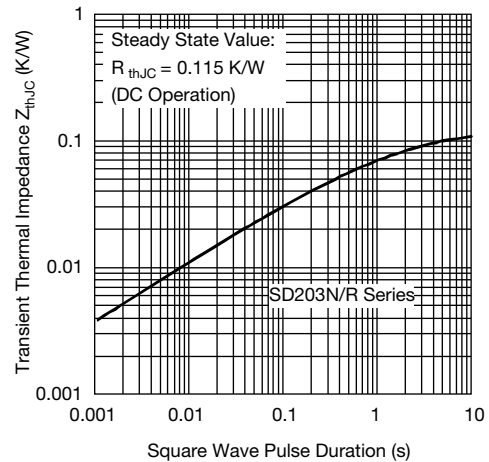

Fig. 8 - Thermal Impedance Z_{thJC} Characteristic

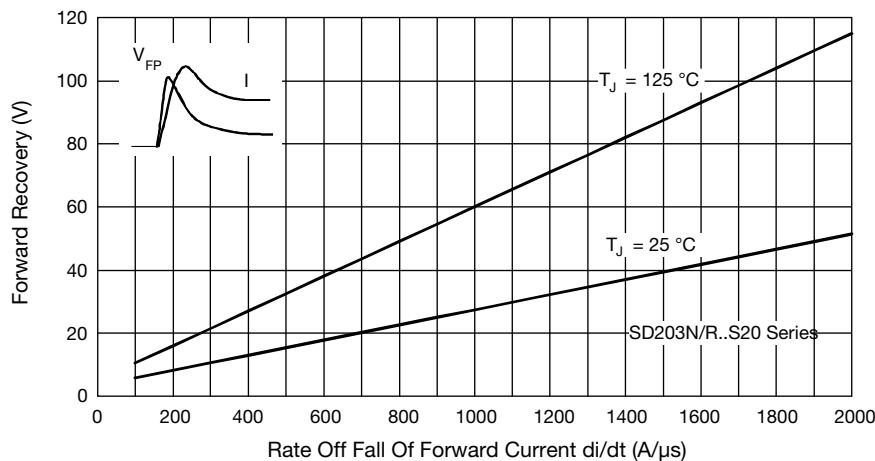

Fig. 9 - Typical Forward Recovery Characteristics

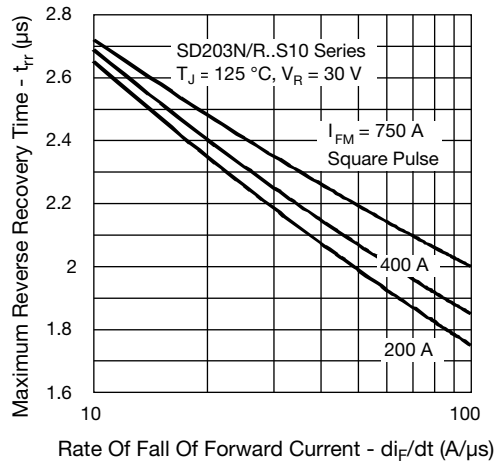

Fig. 10 - Recovery Time Characteristics

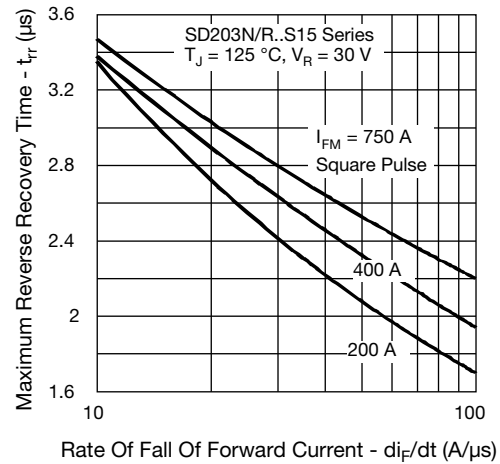

Fig. 13 - Recovery Time Characteristics

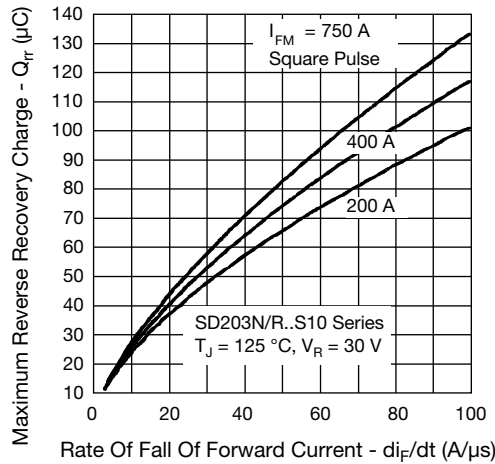

Fig. 11 - Recovery Charge Characteristics

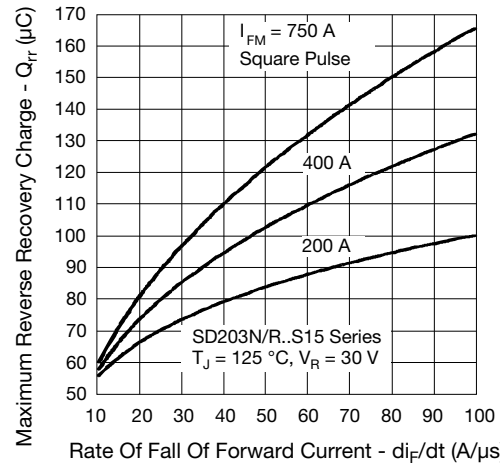

Fig. 14 - Recovery Charge Characteristics

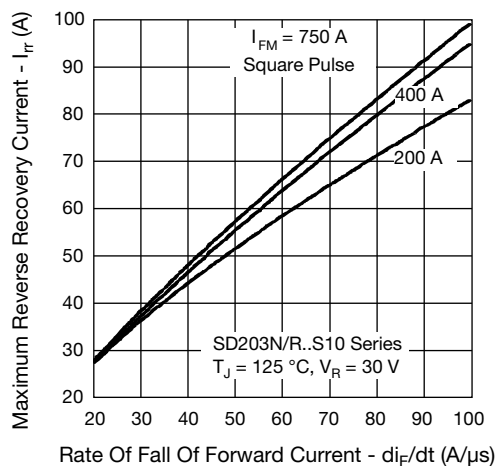

Fig. 12 - Recovery Current Characteristics

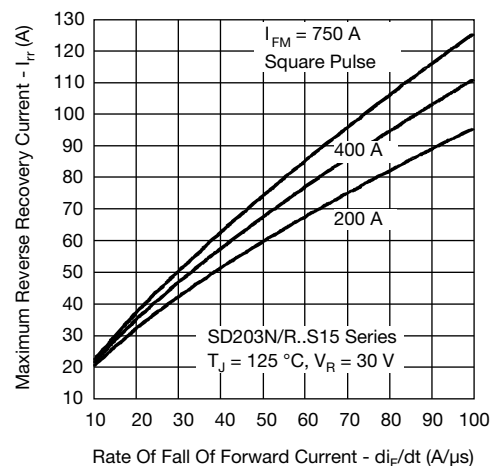

Fig. 15 - Recovery Current Characteristics

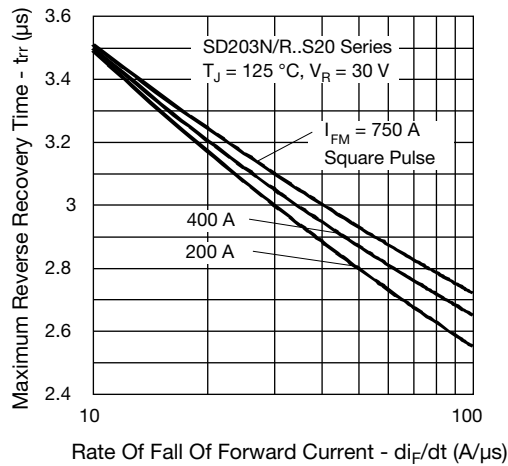

Fig. 16 - Recovery Time Characteristics

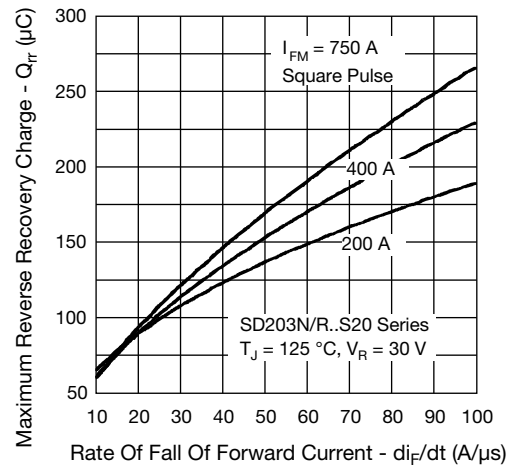

Fig. 17 - Recovery Charge Characteristics

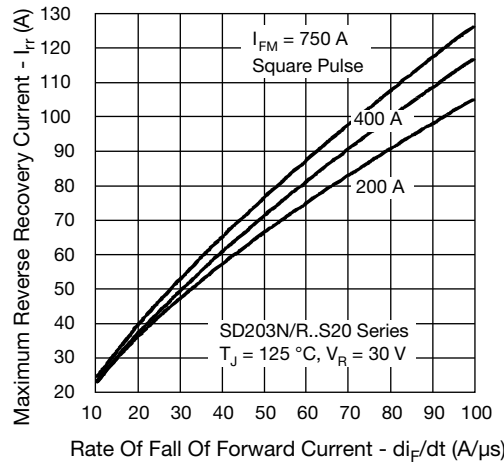

Fig. 18 - Recovery Current Characteristics

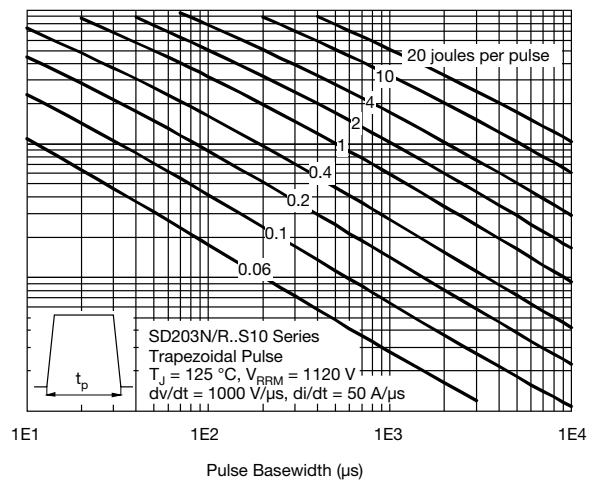
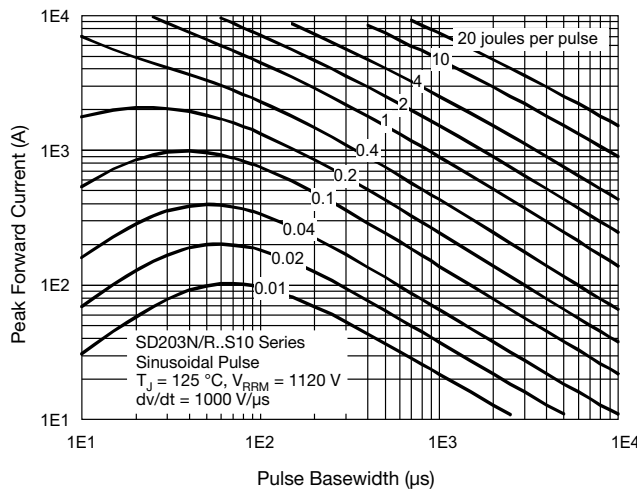

Fig. 19 - Maximum Total Energy Loss Per Pulse Characteristics

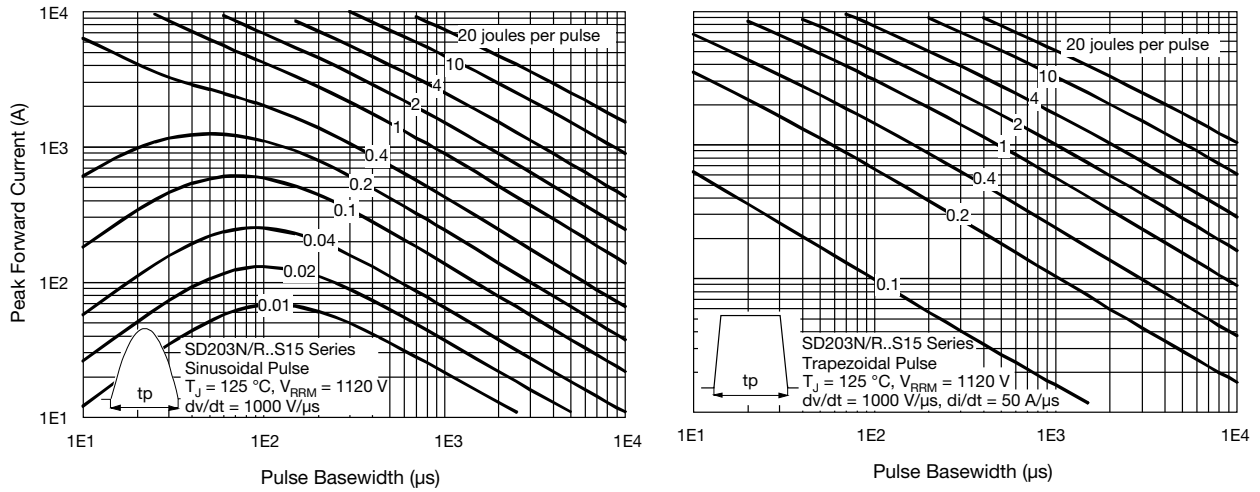

Fig. 20 - Maximum Total Energy Loss Per Pulse Characteristics

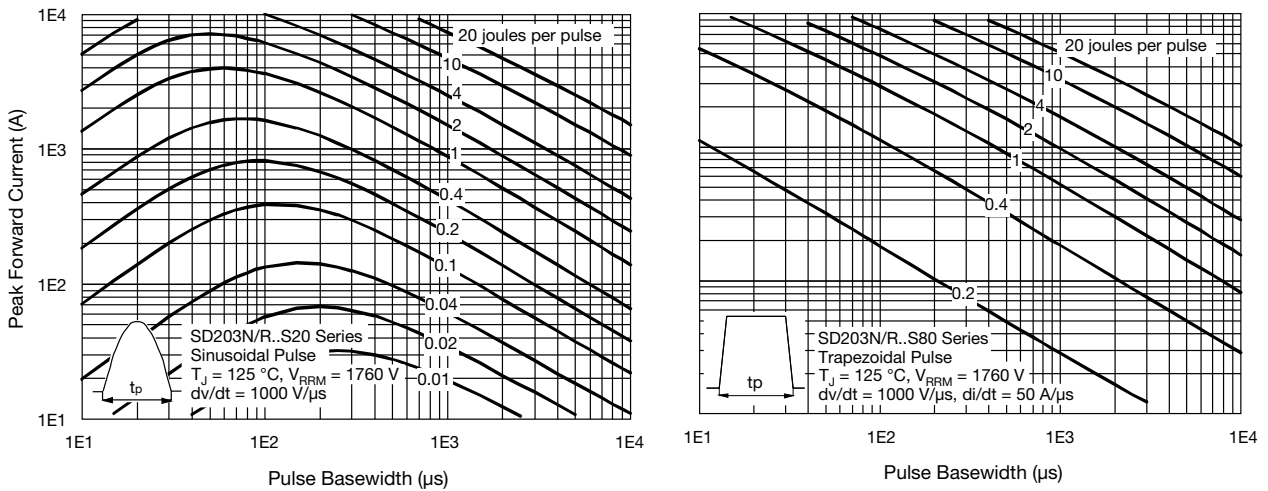
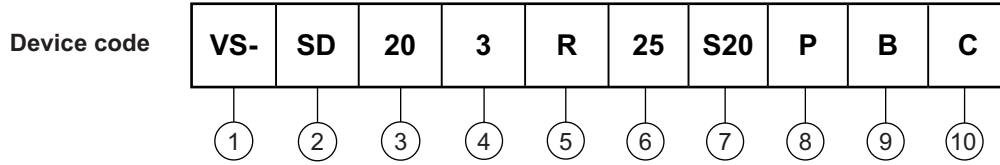

Fig. 21 - Maximum Total Energy Loss Per Pulse Characteristics



ORDERING INFORMATION TABLE



- 1** - Vishay Semiconductors product
- 2** - Diode
- 3** - Essential part number
- 4** - 3 = fast recovery
- 5** -
 - N = stud normal polarity (cathode to stud)
 - R = stud reverse polarity (anode to stud)
- 6** - Voltage code x 100 = V_{RRM} (see Voltage Ratings table)
- 7** - t_{rr} code (see Recovery Characteristics table)
- 8** -
 - P = stud base DO-9 (DO-205AB) 3/4" 16UNF-2A
 - M = stud base DO-9 (DO-205AB) M16 x 1.5
- 9** -
 - B = flag top terminals (for cathode / anode leads)
 - S = isolated lead with silicon sleeve (red = reverse polarity; blue = normal polarity)
 - None = not isolated lead
- 10** -
 - C = ceramic housing (over 1600 V)
 - V = glass-metal seal (only up to 1600 V)

LINKS TO RELATED DOCUMENTS	
Dimensions	www.vishay.com/doc?95301

DO-205AB (DO-9)

DIMENSIONS in millimeters (inches)

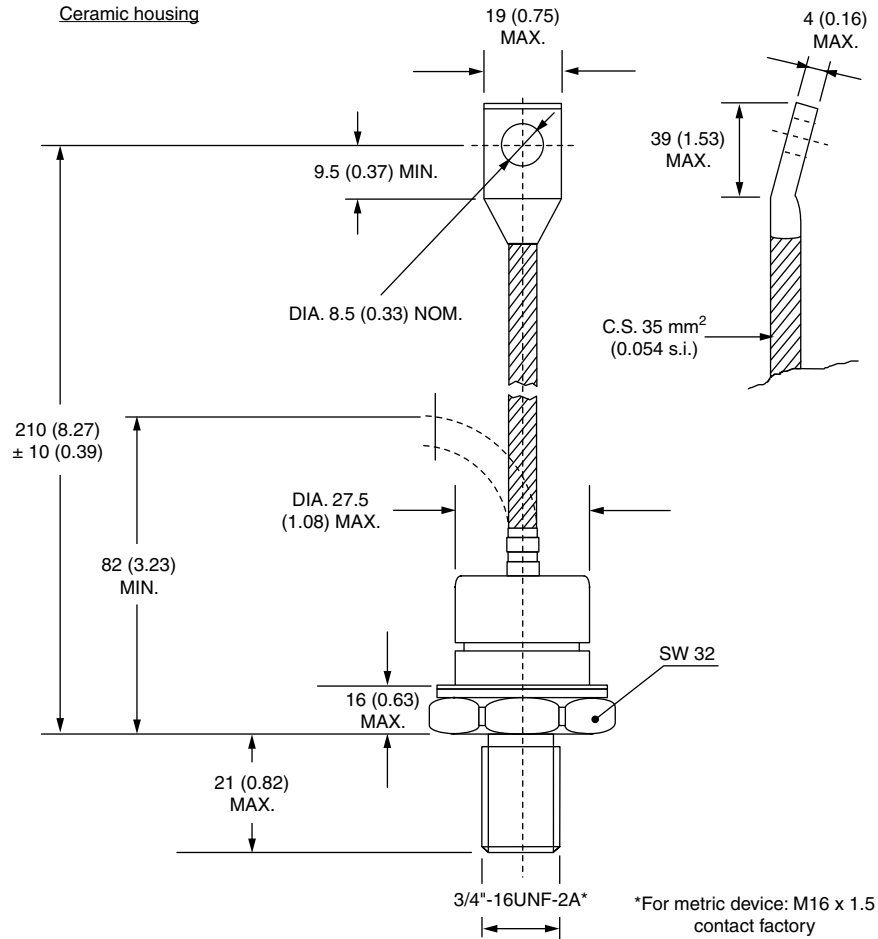



Disclaimer

ALL PRODUCT, PRODUCT SPECIFICATIONS AND DATA ARE SUBJECT TO CHANGE WITHOUT NOTICE TO IMPROVE RELIABILITY, FUNCTION OR DESIGN OR OTHERWISE.

Vishay Intertechnology, Inc., its affiliates, agents, and employees, and all persons acting on its or their behalf (collectively, "Vishay"), disclaim any and all liability for any errors, inaccuracies or incompleteness contained in any datasheet or in any other disclosure relating to any product.

Vishay makes no warranty, representation or guarantee regarding the suitability of the products for any particular purpose or the continuing production of any product. To the maximum extent permitted by applicable law, Vishay disclaims (i) any and all liability arising out of the application or use of any product, (ii) any and all liability, including without limitation special, consequential or incidental damages, and (iii) any and all implied warranties, including warranties of fitness for particular purpose, non-infringement and merchantability.

Statements regarding the suitability of products for certain types of applications are based on Vishay's knowledge of typical requirements that are often placed on Vishay products in generic applications. Such statements are not binding statements about the suitability of products for a particular application. It is the customer's responsibility to validate that a particular product with the properties described in the product specification is suitable for use in a particular application. Parameters provided in datasheets and / or specifications may vary in different applications and performance may vary over time. All operating parameters, including typical parameters, must be validated for each customer application by the customer's technical experts. Product specifications do not expand or otherwise modify Vishay's terms and conditions of purchase, including but not limited to the warranty expressed therein.

Hyperlinks included in this datasheet may direct users to third-party websites. These links are provided as a convenience and for informational purposes only. Inclusion of these hyperlinks does not constitute an endorsement or an approval by Vishay of any of the products, services or opinions of the corporation, organization or individual associated with the third-party website. Vishay disclaims any and all liability and bears no responsibility for the accuracy, legality or content of the third-party website or for that of subsequent links.

Except as expressly indicated in writing, Vishay products are not designed for use in medical, life-saving, or life-sustaining applications or for any other application in which the failure of the Vishay product could result in personal injury or death. Customers using or selling Vishay products not expressly indicated for use in such applications do so at their own risk. Please contact authorized Vishay personnel to obtain written terms and conditions regarding products designed for such applications.

No license, express or implied, by estoppel or otherwise, to any intellectual property rights is granted by this document or by any conduct of Vishay. Product names and markings noted herein may be trademarks of their respective owners.