

3528 贴片式发光二极管

特点 (Characteristics) :

- * 外观尺寸 (L/W/H) :3.5*2.8*1.9mm
Outline Dimensions (L / w / h): 3.5*2.8*1.9mm
- * 发光颜色及胶体: 七彩幻彩/无色雾状
Luminous color and colloid: Colorful magic / colorless fog
- * 环保工艺符合ROHS要求
Environmental protection products Complied With ROHS Directive
- * EIA规范标准包装
EIA standard packaging
- * 适用于SMT贴片自动化生产
Suitable for SMT automatic production
- * 适用于红外线回流焊制程
Suitable for infrared reflow soldering process

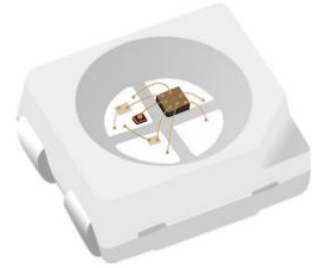

应用领域 (Product application) :

- * 医用设备: 内窥镜、血氧仪
Medical equipment: endoscope、oximeter
- * 汽车电子: 背光按键灯、指示灯
Automotive electronics: backlight key light、indicator light
- * 工业产品: 电子仪表盘、工业设备
Industrial products: electronic instrument panel、industrial equipment
- * 智能家居: 白色家电、数码管LED
Smart home: white appliances, nixie tube LED
- * 通讯产品: 手机按键灯、路由器、电视盒
Communication products: mobile phone button lamp, router



功能特点/Functional characteristics:

1. 3528灯珠内部集成高质量外控单线级联恒流IC和优质RGB LED芯片，体积小，外围简单。

The 3528 ball interior integrates high-quality external single-line cascade IC and high-quality RGB LED chips, which are small in size and simple on the periphery.

2. 内置IC恒流精度高，内部RGB芯片预先分光处理。发光高度一致，白光效果纯正。

BUILT-IN IC constant current high precision, internal RGB chip pre-optical processing. High Degree of uniformity of light, white light effect pure.

3. 整形转发强化技术，单线数据传输，可无限级联。

Plastic forwarding enhancement technology, single-line data transmission, can be cascaded.

4. 数据传输频率800Kbps/秒，可实现画面刷新速率30帧/秒时，不小于1024点。

The data transmission frequency is 800Kbps per second, and the screen refresh rate can be achieved at 30 frames per second, not less than 1024 points.

5. 输出端口PWM控制能够实现256级灰度调节，端口扫描频率1.5KHz/s。

The output port PWM control can achieve 256 levels of grayscale adjustment, and the port scan frequency is 1.5 KHz / S.

6. 采用优化预置12mA/通道恒流模式，低压驱动级联数量最大化。高恒流精度，片内误差<1.5%，片间误差<3%。Optimized preset 12mA / channel constant current mode is adopted to maximize the number of low-voltage drive cascades. High constant current accuracy, intraslice error < 1.5 %, interslice error < 3 %.

7. 内置低压强化模块，VDD在2.7V以上100%正常工作。

With the built-in low-pressure reinforcement module, VDD is 100 % functional above 2.7 V.

8. 超强数据整形能力：接受完本单元数据自动将后续数据整形输出。

Super data shaping ability: accept this unit data automatically will follow the data shaping output.

.....

目录

Catalogue

电性参数

Electrical Characteristics.....4

可靠性实验

Reliability Test Items And
Conditions.....11

外形尺寸

Outline Dimensions.....12

包装

Packaging.....13

焊接指导

Guideline for Soldering.....15

使用注意事项

Precautions.....17

电性参数

Electrical Characteristics

最大额定值 (TA=25°C, VSS=0V) :

Absolute Maximum Ratings (ta=25 °C, vss=0v):

参数Parameter	符号Symbol	范围Range	单位Unit
逻辑电源电压 Logic supply voltage	Vdd	6.5	V
输出端口耐压 Output port withstand voltage	Vout	24	V
逻辑输入电压 Logic input voltage	Vi	-0.5 ~ Vdd + 0.5	V
工作温度 Working temperature	Topt	-40 ~ +85	°C
储存温度 Storage temperature	Tstg	-55 ~ +150	°C
湿度敏感等级 Humidity sensitivity level	MSL	5a	-

推荐工作范围 (Ta=-40 ~ +85 °C, Vss=0V) :

Recommended working range (ta=-40 ~ +85 °C, vss=0v):

参数 Parameter	符号 Symbol	最小 Min	典型 Typ	最大 Max	单位 Unit
逻辑电源电压 Logic supply voltage	Vdd	-	5.2	6.5	V
高电平输入电压 High level input voltage	Vih	0.7 Vdd	-	Vdd	V
低电平输入电压 Low level input voltage	Vil	0	-	0.3 Vdd	V
输出端口耐压 Output port withstand voltage	Vout	24	-	-	V

电气参数 (Ta=-40 ~ +85 °C, Vss=0V, Vdd=4.5 ~ 5.5V) :

Electrical parameters (ta=-40 ~ +85 °C, vss=0v, vdd=4.5 ~ 5.5V):

参数 Parameter	符号 Symbol	最小 Min	典型 Typ.	最大 Max	单位 Unit	测试条件 Test conditions
低电平输出电流 Low level output current	Iout	-	12	-	mA	R, G, B
低电平输出电流 Low level output current	Ido	10	-	-	mA	Vo = 0.4V, Dout
输入电流 Input current	Ii	-	-	±1	μA	-
输出管脚电流 Output pin current	Isink	-	12	-	mA	-
高电平输入电压 High level input voltage	Vih	0.7Vdd	-	-	V	DIN, SET
低电平输入电压 Low level input voltage	Vil	-	-	0.3Vdd	V	DIN, SET
滞后电压 Hysteresis voltage	Vh	-	0.35	-	V	DIN, SET
电流偏移量 (通道间) Current offset (between channels)	dIout	-	±1.5	±3.0	%	Vds=1V, Iout=12mA
电流偏移量 (芯片间) Current offset (between chips)	dIout	-	±3.0	±5.0	%	Vds=1V, Iout=12mA
电流偏移量 VS-Vds Current offset vs VDS	%dVds	-	±0.1	±0.5	%/V	1V<Vds<3V
电流偏移量 VS-Vdd Current offset vs VDD	%dVds	-	±1.0	±2.0	%/V	4.5V<Vdd<5.5V
动态电流损耗 Dynamic current loss	IDDdyn	无负载 No load	-	-	1	mA
消耗功率 Consumed power	PD	Ta=25°C	-	-	250	mW
热阻值 Thermal resistance value	Rth(j-a)	-	80	-	190	°C/W

开关特性 (Ta=-40~+85℃, Vss=0V, Vdd=4.5~5.5V) :

Switching characteristics (ta=-40~+85℃, vss=0v, vdd=4.5~5.5V):

参数 Parameter	符号 Symbol	最小 Min	典型 Typ	最大 Max	单位 Unit	测试条件 Test conditions
振荡频率 oscillation frequency	FOSC1	-	800	-	KHz	Vdd =5V
	FOSC2	-	10	-	MHz	Vdd =5V
传输延迟时间 Transmission delay time	Tflz	-	-	300	ns	CI= 15 pF, DIN → DOUT, RI = 10 kΩ
下降时间 Descent time	Tthz	-	-	120	μs	CI = 300 pF, OUTR/OUTG/OUTB
数据传输率 Data transmission rate	Fd	800	-	-	Kbps	占空比50% 50% duty cycle
输入电容 Input capacitance	Ci	-	-	15	pF	-

* 注: 脉冲宽度≤0.1ms, 占空比≤1/10

* Note: Pulse width≤0.1ms, Duty≤1/10

光电参数 (温度=25℃) :

Electro-Optical Characteristics (Temperature=25°C):

参数名称 Parameter	颜色 Colour	符号 Symbol	测试条件 Test conditions	最小值 Min	典型值 Typ	最大值 Max	单位 Unit
光强 Light intensity	红red	IV	IF=20mA	300	-	1000	mcd
	绿green			1500	-	4000	
	蓝blue			120	-	600	
主波长 Mainwavelength	红red	Dλ		620	-	630	nm
	绿green			510	-	530	
	蓝blue			460	-	475	
正向电压 Forward voltage	红red	VF		1.8	-	2.4	V
	绿green			2.8	-	3.4	
	蓝blue			2.8	-	3.4	
半光强视角 Half light angle	-	2θ1/2	-	120	-	Deg	

亮度分档:

Brightness grading:

颜色 Colour	代码 Code	最小值 Min	最大值 Max	单位 Unit	测试条件 Test conditions
红red	Z11	300	1000	mcd	IF = 20mA
绿green	Z41	1500	4000		
蓝blue	T64	120	600		

电压分档:

Voltage grading:

颜色 Colour	代码 Code	最小值 Min	最大值 Max	单位 Unit	测试条件 Test conditions
红red	V05	1.8	2.4	V	IF = 20mA
绿green	JQ6	2.8	3.4		
蓝blue	JQ6	2.8	3.4		

波长分档:

Wavelength grading:

颜色 Colour	代码 Code	最小值 Min	最大值 Max	单位 Unit	测试条件 Test conditions
红red	R2	620	630	nm	IF = 20mA
绿green	TG41	510	530		
蓝blue	PB13	460	475		

芯片级联方法: Chip cascade method:

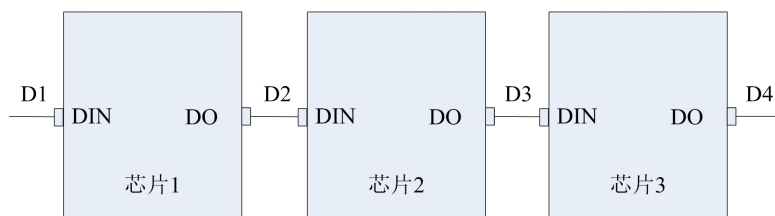

芯片级联方法: Chip cascading method:

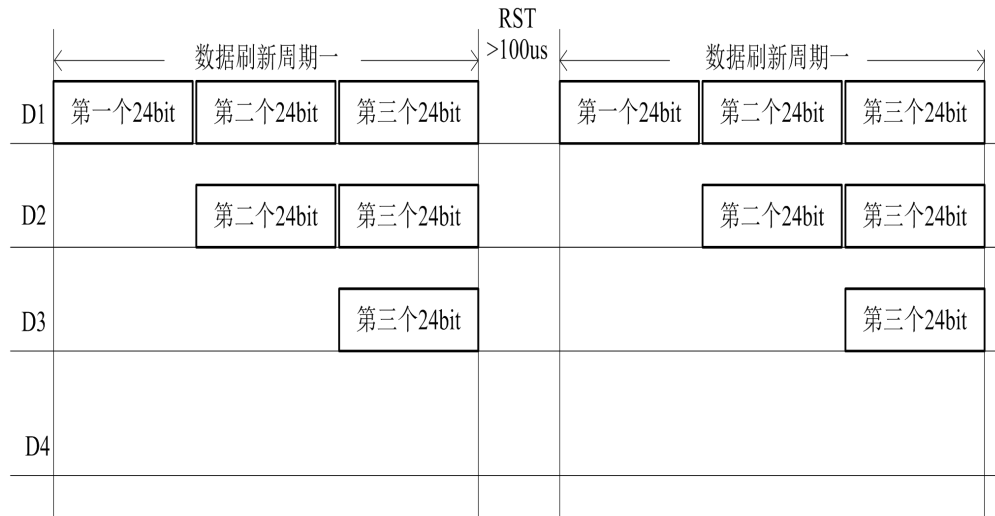

注: 其中D1为MCU端发送的数据, D2、D3、D4为级联电路自动整形转发的数据

Note: D1 refers to the data sent by MCU, and D2, D3 and D4 refer to the data automatically shaped and forwarded by cascade circuit

24bit数据结构: 24bit data structure:

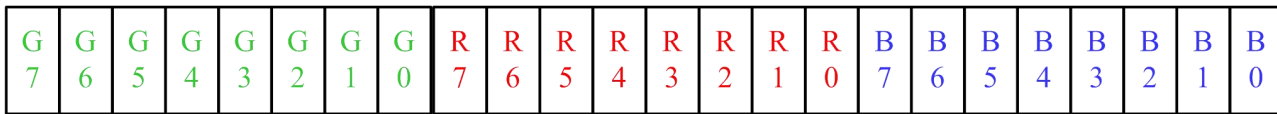

注: 高位先发, 按照GRB的顺序发送数据

Note: high order first send, send data in the order of GrB

时序波形图: Time sequence waveform:

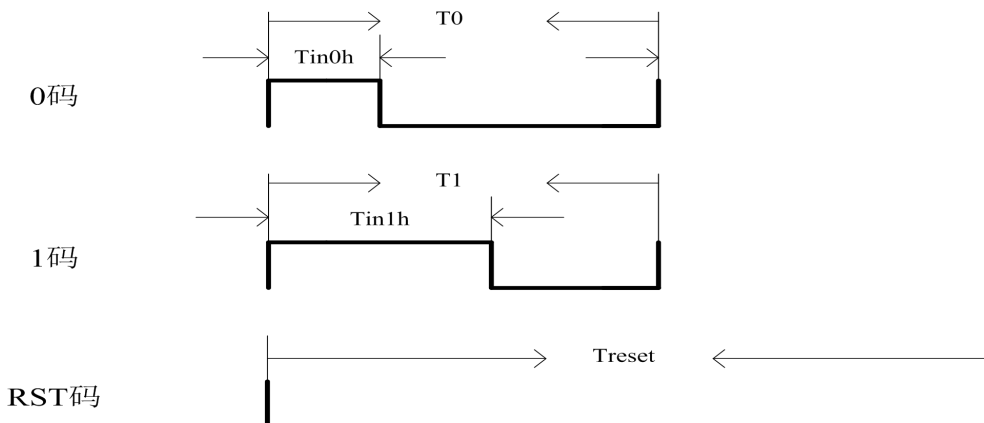

信号传输定义Signal transmission definition

参数 Parameter	符号 Symbol	最小值 Min	最大值 Max	单位 Unit	最小值 Min
输入 0 码高电平时间 Input 0 code high level time	Tin0h	0.20	0.28	0.35	us
输入 1 码高电平时间 Input 1 code high level time	Tin1h	0.65	0.9	1.0	us
输入 0 码低电平时间 Input 0 code low level time	T0L	1.55	1.72	30	us
输入 1 码低电平时间 Input 1 code low level time	T1L	1.10	1.10	30	us
0 码/1 码周期 0 code /1 code cycle	T0/T1	1.75	-	35	us
RESET 码低电平时间 Reset code low level time	Treset	100	150	-	us

注/Note: a: 3528RGB主要根据高电平时间判断“0”码和“1”码。高电平时间介于200ns~410ns, IC判断为“0”码, 高电平时间介于640ns~1000ns, 判断为“1”码。“0”码和“1”码的低电平代表此码结束, 准备接收下一数据码。

a: 3528RGB is mainly based on high-voltage flat time to determine "0" code and "1" code. The high power level time is between 200ns ~ 410ns, IC is judged to be "0" code, high power level time is between 640ns ~ 1000ns, and it is judged to be "1" code. The low levels of the "0" code and the "1" code represent the end of this code and are ready to receive the next data code.

b: 低电平复位时间最小为100us, 为了留有裕度, 一帧数据传输过程中(包括24bit和24bit之间、bit和bit之间)不要中断超过35us, 否则可能会被IC认为是RESET。中断时间在35us之内, 控制器可以进行正常数据传输等其他操作。

b: The low flat reset time is a minimum of 100us. In order to leave a margin, do not interrupt more than 35us during a frame data transmission(including between 24bit and 24bit, between bit and bit), otherwise it may be considered by IC as RESET. The interrupt time is within 35us, and the controller can perform other operations such as normal data transmission.

控制器时序建议值

Recommended value of controller timing

名称 name	描述 Description	典型值 Typical value	建议设定值 Recommended setting value
T0H	0码, 高电平时间 0 code, high level time	0.28us	0.28us
T1H	1码, 高电平时间 1code, high level time	0.9 us	0.9 us
T0L	0码, 低电平时间 0 code, low level time	>1.72μs	1.72μs
T1L	1码, 低电平时间 1 code, low level time	>1.1us	1.1μs
T	“0”码或“1”码周期 "0" code or "1" code cycle	>2.0us	--
Treset	Reset码, 低电平时间 Reset code, low level time	>100us	150 us

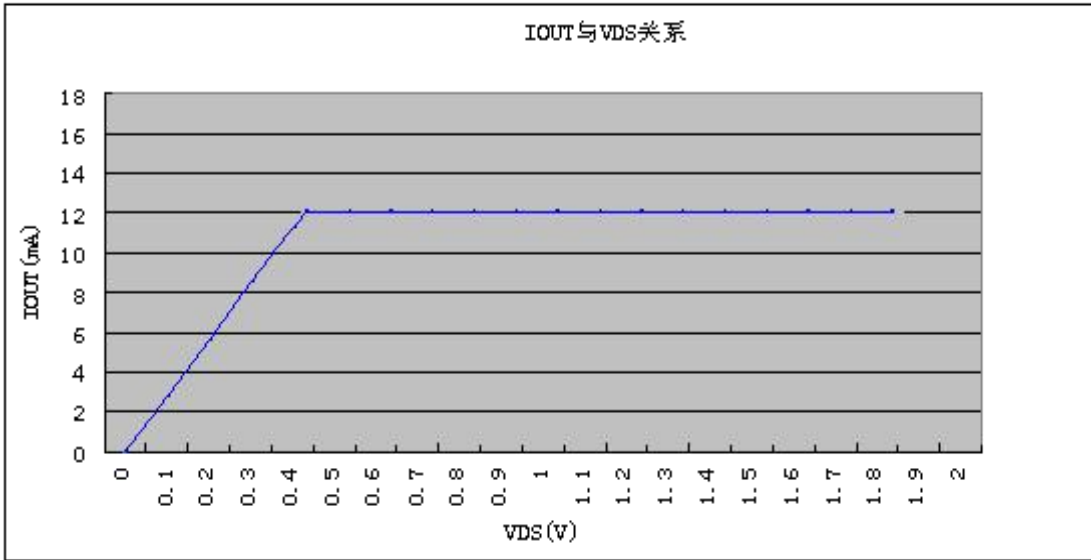

内置 IC恒流特性优异，通道间甚至芯片间的电流差异极小。

(1)通道间的最大电流误差小于±1.5%，而芯片间的最大电流误差小于±3%。

(2)当负载端电压发生变化时，输出电流不受影响，如下图所示

The built-in IC has excellent constant current characteristics, and the current difference between channels and even between chips is very small.

(1) The maximum current error between channels is less than ±1.5%, while the maximum current error between chips is less than ±3%.

(2) When the load terminal voltage changes, the output current is not affected, as shown in the following figure

应用线路图:

Application circuit diagram:

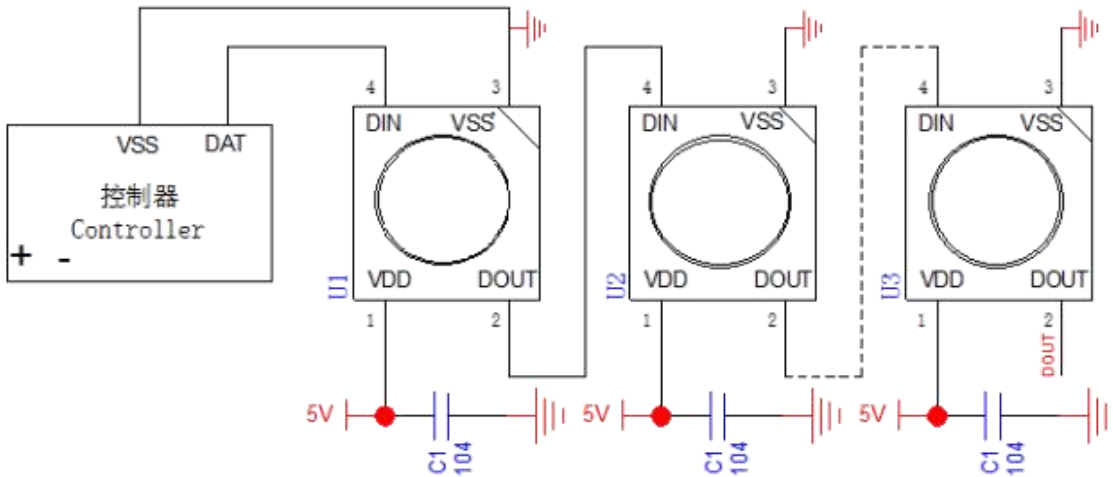

产品应用中驱控灯珠级联数量及控制器参数配置、驱动电源品质均有较大差异，故请在批量使用产品前，客户方务必自行验证产品兼容性，我司不承诺满足客户所有应用需求。

In the application of the product, there are great differences in the cascade number of drive control light beads, the parameter configuration of the controller and the quality of the drive power supply. Therefore, before using the product in batch, the customer must verify the compatibility of the product by himself. Our company does not promise to meet all the application needs of the customer

可靠性实验 Reliability experiment

类别 Class	测试项目 Test item	测试环境 Testing environment	测试时间 Testing time	参考标准 Reference standard
耐久性测试 Endurance test	工作寿命 Working life	室温条件下以最大额定电流持续点亮； 以20mA测试 (Continuous lighting at the maximum rated current at room temperature;Test it at 20mA.)	1000小时 1000 hours (-24小时, +72小时) (-24hours, +72hours)	MIL-STD-750D:1026 MIL-STD-883D:1005 JIS C 7021:B-1
	高温高湿储存 High temperature and high humidity	IR-Reflow In-Board, 2 Times 环境温度Ta= 85±5℃,相对湿度RH= 90~95%	240小时 240hours (±2小时) (±2hours)	MIL-STD-202F:103B JIS C 7021:B-11
	高温储存High -temperature storage	环境温度Ta= 85±5℃	1000小时 1000 hours (-24小时 +72小时) (-24hours+72hours)	MIL-STD-883D:1008 JIS C 7021:B-10
	低温储存Low temperature storage	环境温度Ta= -40±5℃		JIS C 7021:B-12
环境测试 Environmental testing	冷热循环Cold and hot cycle	105℃ ~ 25℃ ~ -55℃ ~ 25℃ 30mins 5mins 30mins 5mins	50次循环 50 Circles	MIL-STD-202F:107D MIL-STD-750D:1051 MIL-STD-883D:1010
	冷热冲击Hot and cold impact	IR-Reflow In-Board, 2 Times 100± 5℃ ~ -40℃ ± 5℃ 20mins 20mins	50次循环 50 Circles	MIL-STD-202F:107D MIL-STD-750D:1051 MIL-STD-883D:1011
	抗锡试验Anti -tin test	焊锡温度T.sol= 260 ± 5℃	10 ± 1secs 2次 2times	MIL-STD-202F:210A MIL-STD-750D:2031 JIS C 7021:A-1
	红外回流焊 无铅制程 Infrared reflowwelding There is lead process	升温速度heat up speed(183℃到最高值)：最大 3℃/秒 维持温度keep temperature在125(±25)℃：不超 过120秒 维持温度keep temperature在183℃以上：60- 150秒 最高温度限制范围maximum temperature： 235℃+5/-0℃ 维持keep在235℃+5/-0℃时间：10-15 秒 降温速度cooling rate：最大6℃/秒	-----	MIL-STD-750D:2031.2 J-STD-020C
	红外回流焊 无铅制程 Infrared reflow welding Lead- free process	升温速度heat up speed (217℃到最高值)：最大 3℃/秒 维持温度keep temperature在175(±25)℃：不超 过180秒 维持温度keep temperature在217℃以上：60- 120秒 最高温度限制范围maximum temperature： 255℃+0/-5℃ 维持keep在255℃+0/-5℃时间：5-10秒 降温速度cooling rate：最大6℃/秒	-----	MIL-STD-750D:2031.2 J-STD-020C
	可焊性试验 Weldability test	焊锡温度Soldering temperatureT.sol= 235 ± 5℃ 浸入速度Immersion speed: 25±2.5 mm/秒 上锡率 ≥95% 焊盘面积 Tin loading rate ≥ 95% pad area	浸入时间: 2±0.5秒 Immersion time: 2 ± 0.5 seconds	MIL-STD-202F:208D MIL-STD-750D:2026 MIL-STD-883D:2003 IEC 68 Part 2-20 JIS C 7021:A-2

外形尺寸

Outline Dimension

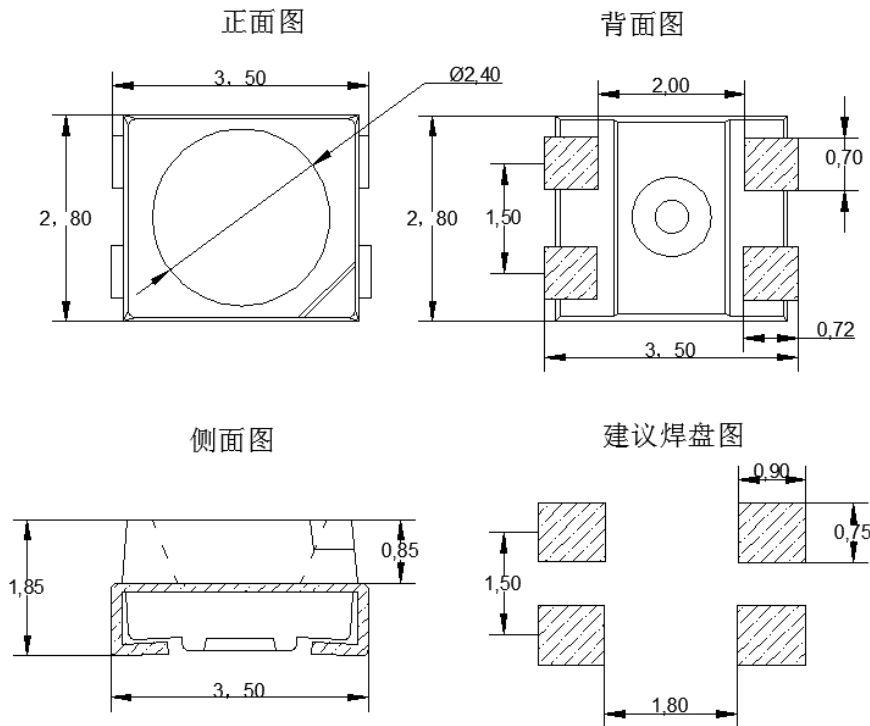

- 备注: 1. 单位: 毫米 (mm)
Remarks: 1 Unit: mm
2. 公差: 如无特别标注则为 ± 0.10 mm
2. Tolerance: ± 0.10 mm unless otherwise specified

引脚电路图及引脚功能:

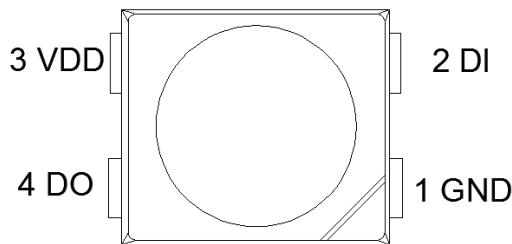

序号 Serial number	符号 Symbol	功能描述 Function description
1	GND	信号地及电源地 Signal ground and power ground
2	DI	显示数据输入 Display data input
3	VDD	内部IC电源正及RGB正极 Internal IC power positive and RGB positive
4	DO	显示数据级联输出 Display data cascade output

包装 (1)

Packaging (1)

载带与圆盘尺寸 Belt and disk dimensions

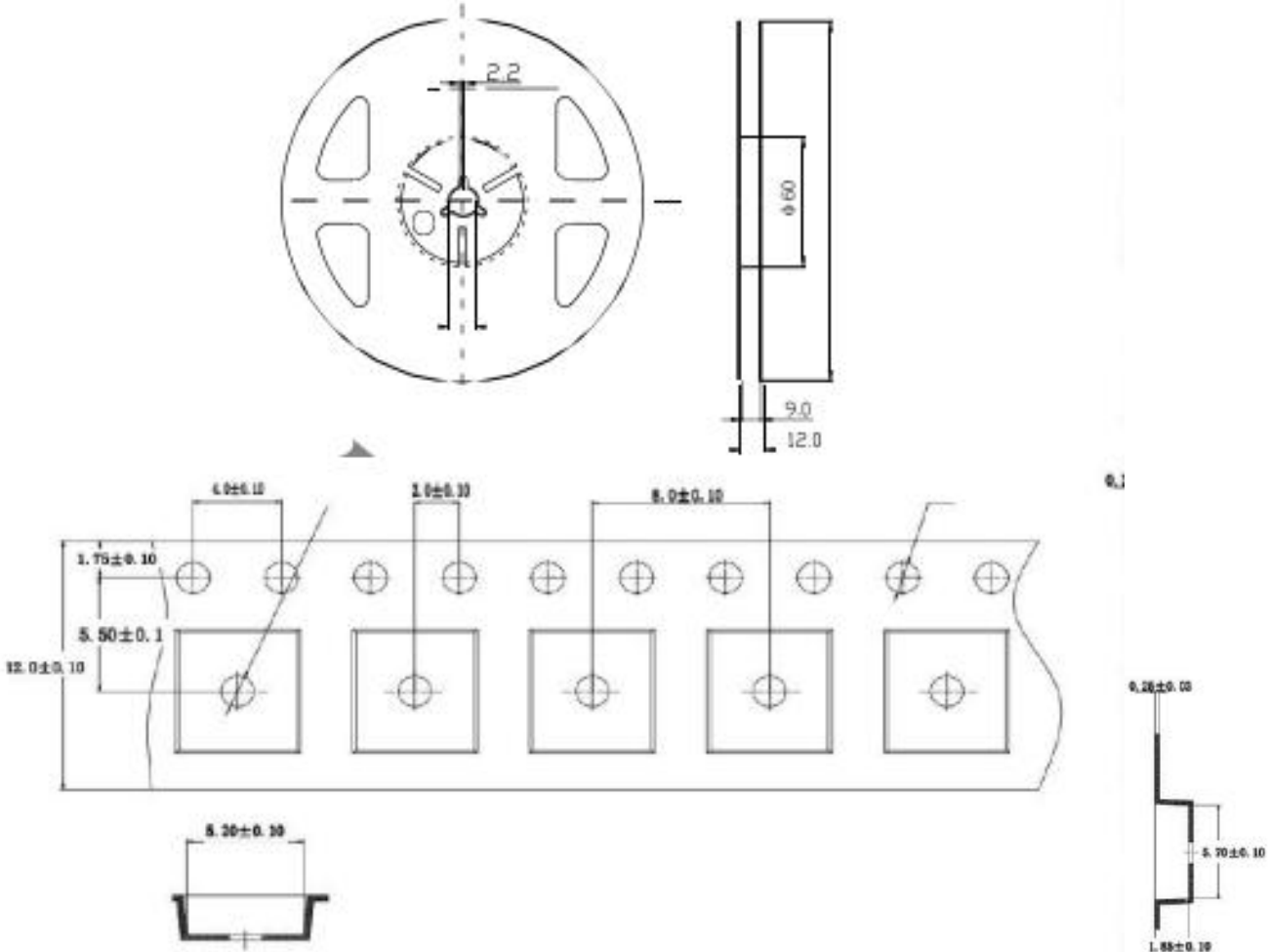

注:

1. 尺寸单位为毫米(mm)。
1. Size unit is mm (mm).
2. 尺寸公差是±0.1mm。
2. The dimensional tolerance is ±0.1mm.

◇ 圆盘及载带卷出方向及空穴规格 Disk and carrier belt direction of roll and hole dimensions

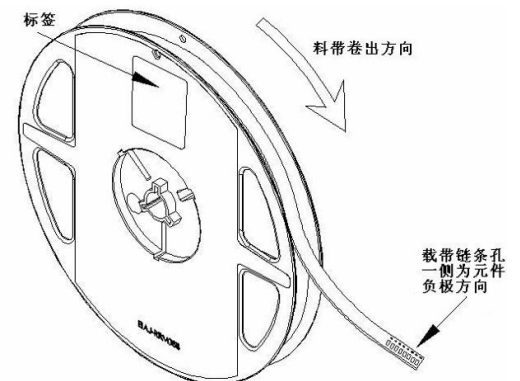
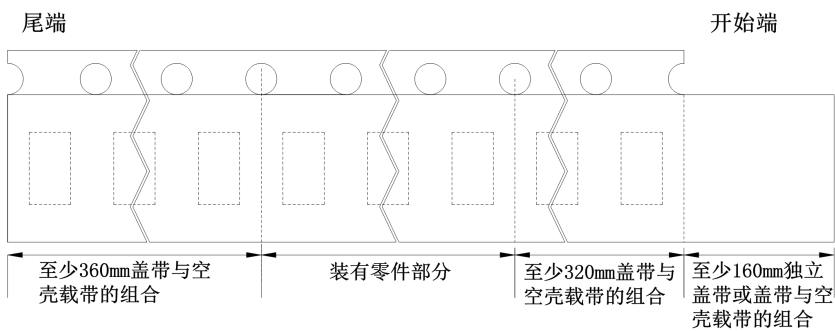

包装 (2)

Packaging (2)

◇ 防潮防静电包装 Moisture Proof and Anti-Electrostatic Foil Bag

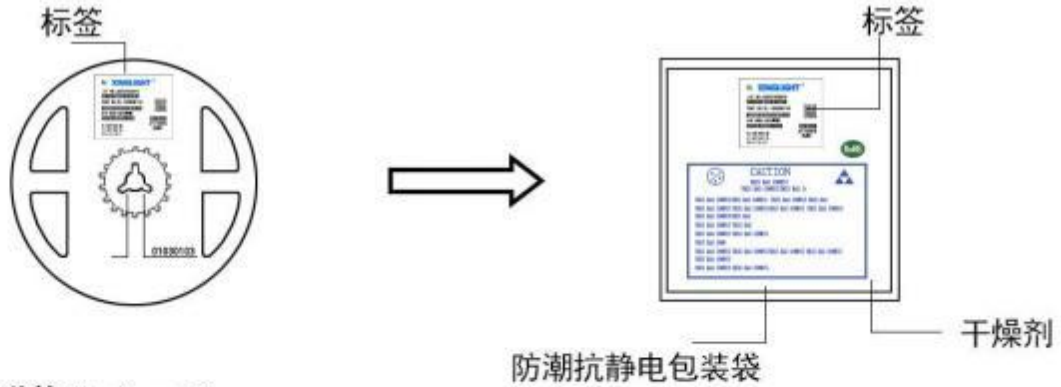

◇ 外包装箱 Cardboard Box

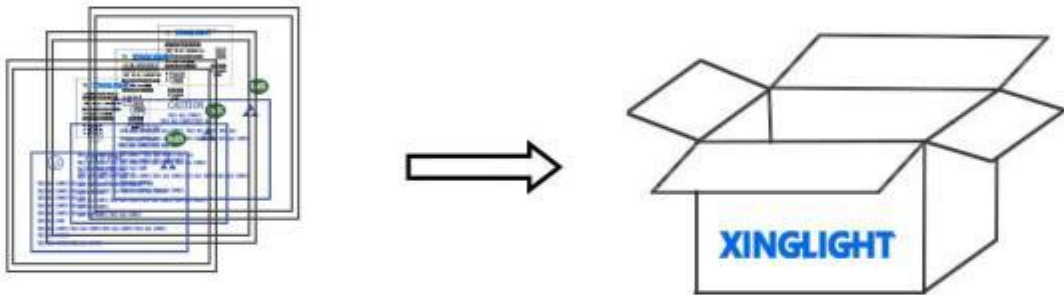

Capacity 5 or 10 reels per box (内箱容量: 50或100卷)

◇ 标签说明: Label Explanation

- LOT NO: 批次信息
- PART NO: 产品型号
- BIN CODE: 产品名称
- WL: 波长范围
- IV: 光强范围
- VF: 电压范围



焊接指导 (1)

Guideline for Soldering (1)

1. 使用烙铁人手焊接

Hand Soldering

只建议在修理和重工的情况下使用手工焊接；推荐使用功率低于 30 W 的烙铁，焊接时烙铁的温度必须保持在 300℃ 以下，且每个电极只能进行一次焊接，每次焊接的持续时间不得超过 3 秒。

人手焊接过程中的不慎操作易引起 LED 产品的损坏，应当小心谨慎。

Manual welding is recommended only for repair and heavy industry situations. A soldering iron of less than 30W is recommended to be used in Hand Soldering. Please keep the temperature of the soldering iron under 300℃ while soldering. Each terminal of the LED is to go for less than 3 second and for one time only.

Be careful because the damage of the product is often started at the time of the hand soldering.

2. 回流焊接：推荐使用以下无铅回流焊接温度图进行。

Reflow Soldering: Use the conditions shown in the under Figure of Pb-Free Reflow Soldering.

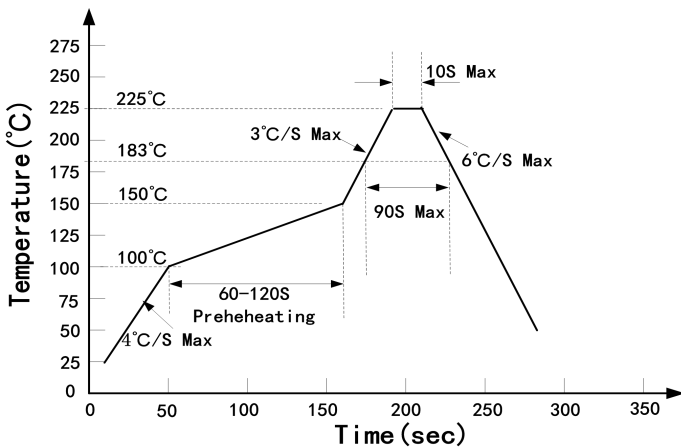

有铅制程 have lead process

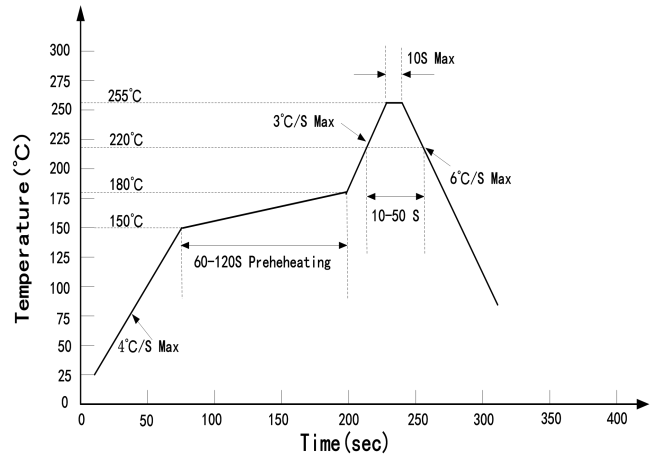

无铅制程 Lead-free process

- 回流焊接最多只能进行两次。

Reflow soldering should not be done more than two times.

- 在回流焊接升温过程中，请不要对 LED 施加任何压力。

Stress on the LEDs should be avoided during heating in soldering process.

- 在焊接完成后，待产品温度下降到室温之后，再进行其他处理。

After soldering, do not deal with the product before its temperature drop down to room temperature.

焊接指导 (2)

Guideline for Soldering (2)

3. 清洗:

Cleaning

在焊接后推荐使用酒精进行清洗，在温度不高于 30°C 的条件下持续 3 分钟，不高于 50°C 的条件下持续 30 秒。使用其他类似溶剂清洗前，请先确认使用的溶剂不会对 LED 的封装和环氧树脂部分造成损伤。

超声波清洗也是有效的方法，一般最大功率不应超过 300W，否则可能对 LED 造成损伤。请根据具体的情况预先测试清洗条件是否会对 LED 造成损伤。

It is recommended that alcohol be used as a solvent for cleaning after soldering. Cleaning is to go under 30°C for 3 minutes or 50°C for 30 seconds. When using other solvents, it should be confirmed beforehand whether the solvents will dissolve the package and the resin or not.

Ultrasonic cleaning is also an effective way for cleaning. But the influence of Ultrasonic cleaning on LED depends on factors such as ultrasonic power. Generally, the ultrasonic power should not be higher than 300W. Before cleaning, a pretest should be done to confirm whether any damage to LEDs will occur.

- * **注意:** 此一般指导原则并不适用于所有 PCB 设计和焊接设备的配置。具体工艺受到诸多因素的影响，请根据特定的PCB设计和焊接设备来确定焊接方案。
- * **Note:** This general guideline may not apply to all PCB designs and configurations of all soldering equipment. The technics in practise is influenced by many factors, it should be specialized base on the PCB designs and configurations of the soldering equipment..

使用注意事项（1）

Precautions (1)

1. 贮存:

Storage

- 本产品使用密封防潮抗静电袋包装，并附有干燥剂，未开封的产品有一年的保存时间。

Moisture proof and anti-electrostatic package with moisture absorbent material is used, to keep moisture to a minimum.

- 开封前，产品须存放在温度不高于 30℃，湿度不高于 40%RH 的环境中。

Before opening the package, the product should be kept at 30℃ or less and humidity less than 40% RH, and be used within a year.

- 开封后，产品须存放在温度不高于 30℃，湿度不高于 10%RH 的环境中，且应该在 24 小时（1天）内使用完；且贴片后应尽快做焊接。建议工作环境为温度不高于 30℃，湿度不高于 40%RH。

After opening the package, the product should be stored at 30℃ or less and humidity less than 10%RH, and be soldered within 24 hours (1 day). And it should be welded as soon as possible after the patch. It is recommended that the product be operated at the workshop condition of 30℃ or less and humidity less than 40%RH.

- 对于尚未焊接的 LED，如果吸湿剂或包装失效，或者产品没有符合以上有效存储条件，烘焙可以起到一定的性能恢复效果。烘焙条件：(60±5)℃，持续 24 小时。

If the moisture absorbent material has fade away or the LEDs have exceeded the storage time, baking treatment should be performed based on the following condition: (60±5)℃ for 24 hours.

2. 静电:

Static Electricity

静电和电涌会导致产品特性发生改变，例如正向电压降低等，如果情况严重甚至会损毁产品。所以在使用时必须采取有效的防静电措施。

所有相关的设备和机器都应该正确接地，同时必须采取其他防止静电和电涌的措施。使用防静电手环，防静电垫子，防静电工作服、工作鞋、手套，防静电容器，都是有效的防止静电和电涌的措施；严禁使用普通塑料制品。建议在作业过程中，使用离子风扇来压制静电的产生。距离LED元件1英尺距离的环境范围内静电场电压小于100V。

Static electricity or surge voltage damages the LEDs. Damaged LEDs will show some unusual characteristic such as the forward voltage becomes lower, or the LEDs do not light at the low current. even not light.

All devices, equipment and machinery must be properly grounded. At the same time, it is recommended that wrist bands or anti-electrostatic gloves, anti-electrostatic containers be used when dealing with the LEDs. Using ordinary plastic products are strictly prohibited. It is recommended to use ion fans to suppress the static electricity generation during the operation. The static field voltage is less than 100V within the ambient range of 1 foot distance from the LED element.

使用注意事项（2）

Precautions (2)

3. 设计建议:

Design Consideration

设计电路时，通过 LED 的电流不能超过规定的最大值，同时，还需使用保护电阻，否则，微小的电压变化将会引起较大的电流变化，可能导致产品损毁。

建议使用以下（A）电路，该电路能够很好的调节通过每个 LED 的电流；不推荐使用（B）电路，该电路在持续的电压驱动下，LED 的正向电压（ V_F ）发生变化，电流会随之而发生变化，可能使某些 LED 承受高于规定的电流值。

In designing a circuit, the current through each LED must not exceed the absolute maximum rating specified for each LED. In the meanwhile, resistors for protection should be applied, otherwise slight voltage shift will cause big current change, burn out may happen.

It is recommended to use Circuit A which regulates the current flowing through each LED rather than Circuit B. When driving LEDs with a constant voltage in Circuit B, the current through the LEDs may vary due to the variation in Forward Voltage (V_F) of the LEDs. In the worst case, some LED may be subjected to stresses in excess of the Absolute Maximum Rating.

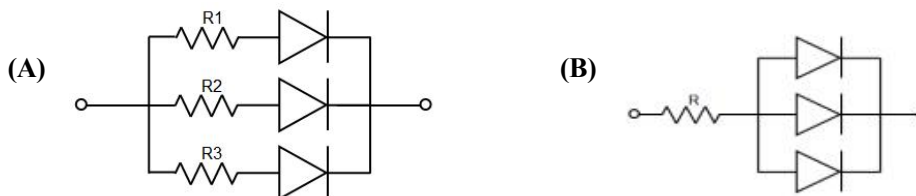

光电参数公差:

正向电压 V_F / V_F : $\pm 0.1V$

亮度 I_V / I_V : $\pm 15\%$

波长 λ / λ : $\pm 1nm$

LED 的特性容易因为自身的发热和环境的温度的改变而发生改变。温度的升高会降低 LED 的发光效率、影响发光颜色等，所以在设计时应充分考虑散热的问题。

Thermal Design is paramount importance because heat generation may result in the Characteristics decline, such as brightness decreased, Color changed and so on. Please consider the heat generation of the LEDs when making the system design.

使用注意事项 (3)

Precautions (3)

4. 其他事项:

Others

直接用手拿取产品不但会污染封装树脂表面，也可能由于静电等因素导致产品性能的改变。过度的压力也可能直接影响封装内部的管芯和金线，因此请勿对产品施加过度压力，特别当产品处于高温状态下，例如在回流焊接过程中。

When handling the product, touching the encapsulant with bare hands will not only contaminate its surface, but also affect on its optical characteristics. Excessive force to the encapsulant might result in catastrophic failure of the LEDs due to die breakage or wire deformation. For this reason, please do not put excessive stress on LEDs, especially when the LEDs are heated such as during Reflow Soldering.

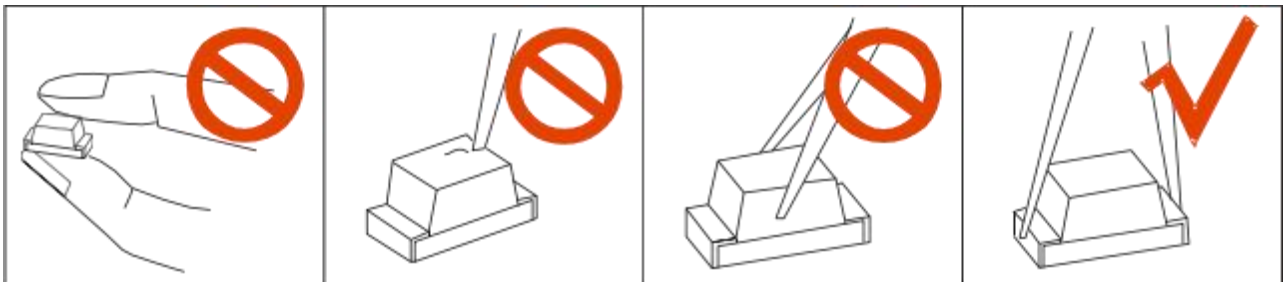

LED 的环氧树脂封装部分相当脆弱，请勿用坚硬、尖锐的物体刮、擦封装树脂部分。在用镊子夹取的时候也应当小心注意。

The epoxy resin of encapsulant is fragile, so please avoid scratch or friction over the epoxy resin surface. While handling the product with tweezers, do not hold by the epoxy resin, be careful.

5. 眼睛保护忠告:

Safety Advice For Human Eyes

LED 发光时，请勿直视发光光源，特别是对于一些光强较高的 LED，强光可能伤害你的眼睛。

Viewing direct to the light emitting center of the LEDs, especially those of great Luminous Intensity, will cause great hazard to human eyes. Please be careful.