



The Future of Analog IC Technology®

# MP2615

## 2A, 1- or 2- Cell Li-ion Battery Charger In 3mm x 3mm Package

### DESCRIPTION

The MP2615 is a high efficiency switch mode battery charger suitable for 1- or 2- cell lithium-ion or lithium-Polymer applications. The MP2615 is capable of delivering 2A of charge current programmable via an accurate sense resistor over the entire input range.

The MP2615 regulates the charge current and full battery voltage using two control loops to achieve high accuracy constant current (CC) charge and constant voltage (CV) charge.

Constant-off-time (COT) mode control allows operation up to 99% duty cycle when the battery voltage is close to the input voltage and in order to keep charge current always at a relative high level.

Battery temperature and charging status are always monitored during each charging cycle. Two status monitor output pins are provided to indicate the battery charging status and input power status. The MP2615 also features internal reverse blocking protection.

The MP2615 is available in a 3mm × 3mm 16-pin QFN package.

### FEATURES

- 4.75V to 18V Operating Input Voltage
- Up to 99% Duty Cycle Operation
- Up to 2A Programmable Charging Current
- ±0.75% Full Battery Voltage Accuracy
- 4.1V/Cell and 4.2V/Cell Selection for Full Battery Voltage
- Full Integrated Power Switches
- Internal Loop Compensation
- No External Reverse Blocking Diode Required
- Preconditioning for Fully Depleted Battery
- Charging Operation Indicator
- Programmable Safety Timer
- Thermal Shutdown Protection
- Cycle-by-Cycle Over Current Protection
- Battery Temperature Monitor and Protection

### APPLICATIONS

- Smart Phones
- Portable Hand-held Solutions
- Portable Media Players

All MPS parts are lead-free and adhere to the RoHS directive. For MPS green status, please visit MPS website under Products, Quality Assurance page.

"MPS" and "The Future of Analog IC Technology" are registered trademarks of Monolithic Power Systems, Inc.

ADAM (Analog Digital Adaptive Modulation) and AAM (Advanced Asynchronous Mode) are trademarks of Monolithic Power Systems, Inc.

### TYPICAL APPLICATION

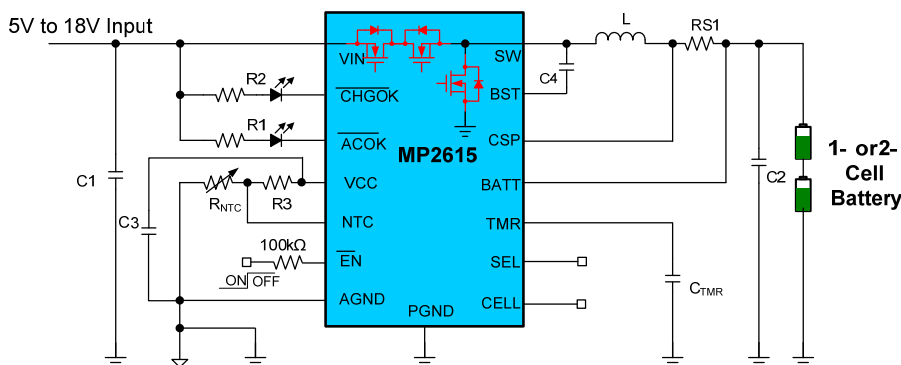

Efficiency Curve

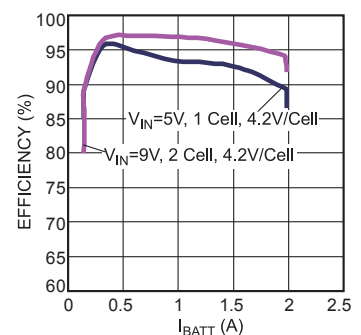

### ORDERING INFORMATION

Part Number*	Package	Top Marking
MP2615GQ	QFN-16 (3mm×3mm)	See Below

\* For Tape & Reel, add suffix -Z (e.g. MP2615GQ-Z);

### TOP MARKING

**AEGY**  
**LLL**

AEG: product code of MP2615GQ  
 Y: year code  
 LLL: lot number

### PACKAGE REFERENCE

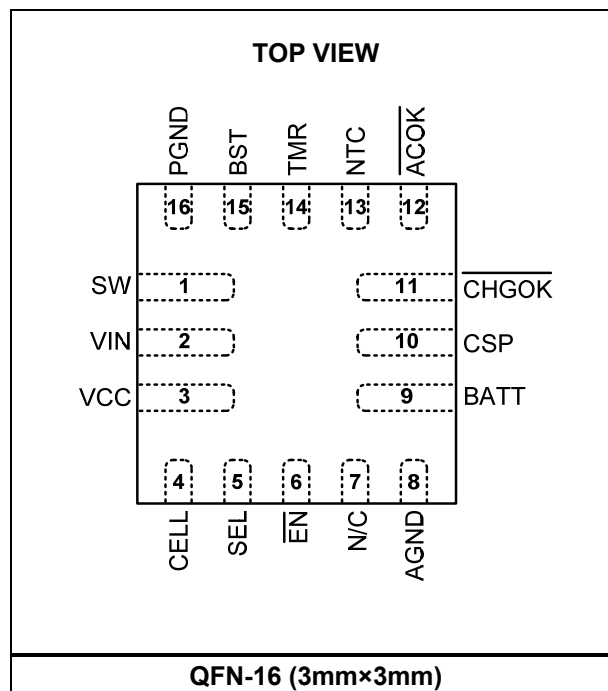

**ABSOLUTE MAXIMUM RATINGS (1)**

$V_{SW}$ .....	-0.3V to 23V
$V_{IN}, V_{ACOK}, V_{CHGOK}$ .....	-0.3V to 23V
$V_{BATT}, V_{CSP}$ .....	-0.3V to 12V
$V_{BST}$ .....	$V_{SW} + 6V$
All Other Pins .....	-0.3V to 6V
Junction Temperature.....	150°C
Lead Temperature .....	260°C
Continuous Power Dissipation ( $T_A = +25^\circ C$ ) (2)	
.....	2.5W
Operating Temperature .....	-40°C to +85°C

**Recommended Operating Conditions (3)**

$V_{IN}$ .....	4.75V to 18V
$V_{BATT}$ .....	2V to 8.4V
Operating Junction Temp. ( $T_J$ ).....	-40°C to +125°C

<b>Thermal Resistance (4)</b>	<b><math>\theta_{JA}</math></b>	<b><math>\theta_{JC}</math></b>
QFN-16 (3mmx3mm).....	50.....	12 ... °C/W

**Notes:**

- 1) Exceeding these ratings may damage the device.
- 2) The maximum allowable power dissipation is a function of the maximum junction temperature  $T_J$  (MAX), the junction-to-ambient thermal resistance  $\theta_{JA}$ , and the ambient temperature  $T_A$ . The maximum allowable continuous power dissipation at any ambient temperature is calculated by  $P_D$  (MAX) =  $(T_J$  (MAX)- $T_A$ )/ $\theta_{JA}$ . Exceeding the maximum allowable power dissipation will cause excessive die temperature, and the regulator will go into thermal shutdown. Internal thermal shutdown circuitry protects the device from permanent damage.
- 3) The device is not guaranteed to function outside of its operating conditions.
- 4) Measured on JESD51-7, 4-layer PCB.

**ELECTRICAL CHARACTERISTICS**
 $V_{IN} = 12V, V_{CELL} = 0V, V_{SEL} = 0V, C1 = 22\mu F, C2=22\mu F, T_A = 25^{\circ}C$ , unless otherwise noted.

Parameter	Symbol	Condition	Min	Typ	Max	Units	
<b>Input Voltage and Current</b>							
Input Voltage	$V_{IN}$	$V_{CELL} = 4V$	4.5	5	18	V	
		$V_{CELL} = 0V$	8.75	12	18		
Under Voltage Lockout Threshold Rising	$V_{UVLO}$		3.55	3.75	3.95	V	
Under Voltage Lockout Threshold Hysteresis				225		mV	
Supply Current	$I_{SHDN}$	$\overline{EN} = 4V$ , Shutdown Current		0.27		mA	
	$I_Q$	$\overline{EN} = 0V$ , Quiescent Current		1.1			
<b>Power MOS</b>							
High-side Switch Resistance	On $R_{H\_DS(ON)}$	Measured from VIN to SW		110		m $\Omega$	
Low-side Switch Resistance	On $R_{L\_DS(ON)}$			110		m $\Omega$	
Switch Leakage		$\overline{EN} = 4V, V_{SW} = 0V$		0	1	$\mu A$	
<b>Frequency and Time Parameter</b>							
Switching Frequency	$F_{SW}$	$V_{BATT} = 7.5V$		760		kHz	
Fold-back Frequency		$V_{BATT} = 0V$		160		kHz	
Minimum Off Time <sup>(5)</sup>	$T_{OFF}$	$V_{BATT} = 9V$		200		ns	
<b>Charging Parameter</b>							
Terminal Battery Voltage	$V_{BATT\_FULL}$	$V_{SEL} = 0V$	4.168	4.2	4.231	V/Cell	
		$V_{SEL} = 4V$	4.069	4.1	4.131		
Battery Over Voltage Threshold	$V_{BOVP}$	$V_{CELL} = 0V, V_{SEL}=0V$	8.34	8.71	9.08		
		$V_{CELL} = 0V, V_{SEL}=4V$	8.14	8.51	8.88		
		$V_{CELL} = 4V, V_{SEL}=0V$	4.17	4.36	4.54		
		$V_{CELL} = 4V, V_{SEL}=4V$	4.07	4.26	4.44		
Recharge Threshold at $V_{BATT}$	$V_{RECH}$	$V_{SEL} = 0V$		4.0			
		$V_{SEL} = 4V$		3.9			
Recharge Hysteresis				150			mV/Cell
Trickle Charge Voltage Threshold	$V_{TC}$	$V_{SEL} = 0V$		3			V/Cell
		$V_{SEL} = 4V$		2.91			
Trickle Charge Hysteresis				225		mV/Cell	
Peak Current Limit		CC	3.2			A	
		Trickle		2.2			
CC Current	$I_{CC}$	$RS1 = 50m\Omega$	1.8	2	2.2	A	
Trickle Charge Current	$I_{TC}$		5%	10%	15%	$I_{CC}$	
Termination Current Threshold	$I_{BF}$		5%	10%	15%	$I_{CC}$	
$V_{IN}$ minimum Head-room (reverse blocking)		$V_{IN} - V_{BATT}$		300		mV	

**ELECTRICAL CHARACTERISTICS (continued)**
 $V_{IN} = 12V, V_{CELL} = 0V, V_{SEL} = 0V, C1 = 22\mu F, C2=22\mu F, T_A = 25^\circ C$ , unless otherwise noted.

Parameter	Symbol	Condition	Min	Typ	Max	Units
Maximum Current Sense Voltage (CSP to BATT)	$V_{SENSE}$		90	100	110	mV
CSP, BATT Current	$I_{CSP}, I_{BATT}$	Charging disabled			3	$\mu A$
ACOK/CHGOK Open-drain Sink Current		$V_{DRAIN} = 0.3V$	5			mA
<b>VCC Regulator Output</b>						
VCC Output Voltage	$V_{CC}$		4.35	4.5	4.65	V
VCC Load Regulation	$\Delta V_{CC}$	$I_{LOAD}=0$ to 10mA			10	mV
<b>EN Control</b>						
$\overline{EN}$ Input Low Voltage					0.4	V
$\overline{EN}$ Input High Voltage			1.8			V
$\overline{EN}$ Input Current	$I_{EN}$	$\overline{EN} = 4V$		4		$\mu A$
		$\overline{EN} = 0V$		0.2		
<b>Logic</b>						
CELL Input Low Voltage	$V_L$				0.4	V
CELL Input High Voltage	$V_H$		1.8			V
SEL Input Low Voltage	$V_L$				0.4	V
SEL Input High Voltage	$V_H$		1.8			V
<b>Timer Protection</b>						
Trickle Charge Time	$t_{Trickle\_tmr}$	$C_{TMR} = 0.47\mu F$		30		Mins
CC/CV Charge Time	$t_{Total\_tmr}$	$C_{TMR} = 0.47\mu F$		165		
<b>NTC Protection</b>						
NTC Low Temp Rising Threshold		$R_{NTC}=NCP18X103, 0^\circ C$	72	73.3	74.6	% $V_{CC}$
NTC Low Temp Rising Threshold Hysteresis			2			
NTC High Temp Falling Threshold		$R_{NTC}=NCP18X103, 50^\circ C$	28	29.3	30.6	
NTC Low Temp Falling Threshold Hysteresis			2			
<b>Thermal Protection</b>						
Thermal Shutdown <sup>(5)</sup>	$T_{SHDN}$			150		$^\circ C$
Thermal Shutdown Hysteresis <sup>(5)</sup>				20		$^\circ C$
<b>Reverse Leakage Blocking</b>						
Battery Reverse Leakage Current	$I_{LEAKAGE}$	$V_{CELL} = 0V$			3	$\mu A$
		$V_{CELL} = 4V$			0.5	$\mu A$

**Notes:**

5) Guaranteed by design.

## PIN FUNCTIONS

Package Pin #	Name	Description
1	SW	Switch Output
2	VIN	Power Supply Voltage.
3	VCC	Coarse Regulator Output. Internally generated 4.5V. Bypass with a 1 $\mu$ F capacitor to AGND. Used to be low-side switch driver and pull-up bias voltage NTC resistive divider. <b>Do not connect any external load at this pin.</b>
4	CELL	Command Input for the Number of Li-Ion Cells. Connect this pin to VCC for 1-cell application and short it to AGND or keep it floating for 2- Cell application.
5	SEL	Input Pin for Setting Terminal Battery Voltage: SEL = Low-level or Float: $V_{BATT} = 4.2V/Cell$ . SEL = High-level: $V_{BATT} = 4.1V/Cell$ .
6	$\overline{EN}$	On/ Off Control Input. This pin is pulled to GND with a 1Meg internal resistor. suggest to connect a 100k $\Omega$ resistor in series with EN pin.
7	N/C	NO CONNECT. <b>Please leave this pin floating.</b>
8	AGND	Analog Ground.
9	BATT	Positive Battery Terminal.
10	CSP	Battery Current Sense Positive Input. Connect a resistor RS1 between CSP and BATT.
11	$\overline{CHGOK}$	Charging Completion Indicator. A logic Low indicates charging operation. The pin will become an open drain once the charge is completed or suspended.
12	$\overline{ACOK}$	Valid Input Supply Indicator. A logic Low on this pin indicates the presence of a valid input power supply.
13	NTC	Thermistor Input. Connect a resistor from this pin to the pin VCC and the thermistor from this pin to ground.
14	TMR	Internal Safety Timer Control. Connect a capacitor from this node to AGND to set the timer. And the timer can be disabled by connecting this pin to AGND directly.
15	BST	Bootstrap pin. A capacitor is needed to drive the power switch's gate above the supply voltage. It is connected between SW and BST pins to form a floating supply across the power switch driver.
16	PGND	Power Ground.

## TYPICAL PERFORMANCE CHARACTERISTICS

$V_{IN} = 5V/9V$ ,  $C1=C2=22\mu F$ ,  $SEL=Float/High$ ,  $CELL=Float/High$ ,  $L=6.8\mu H$ ,  $RS1=50m\Omega$ , Battery Simulator,  $T_A = 25^\circ C$ , unless otherwise noted.

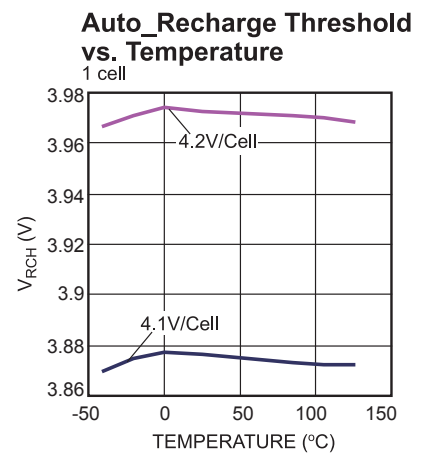
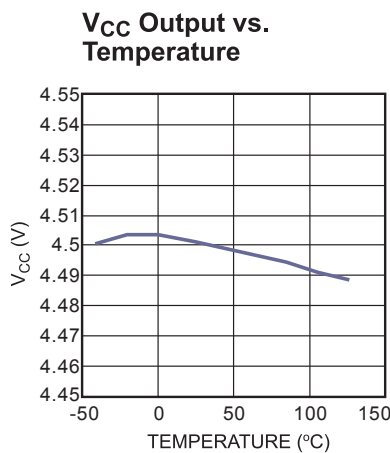
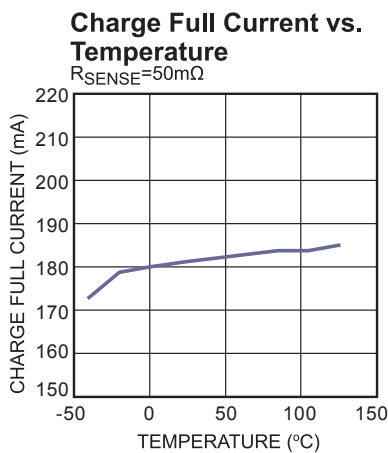
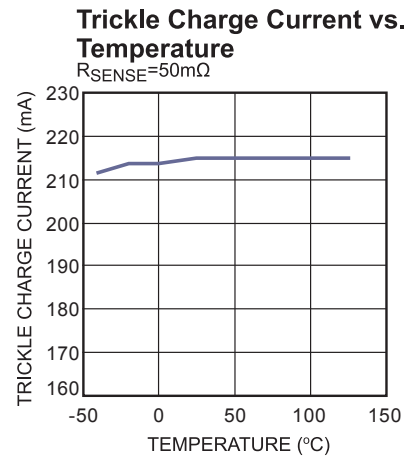
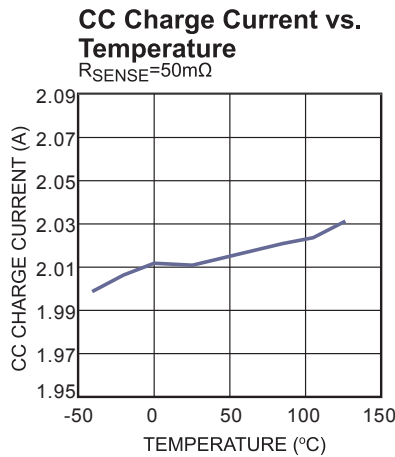
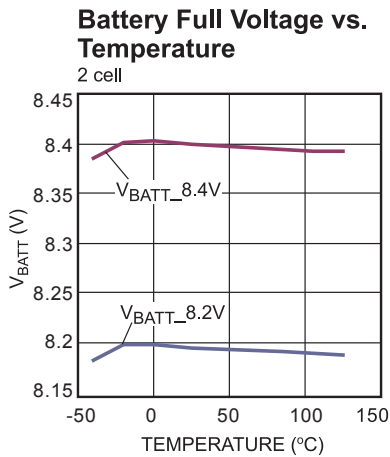
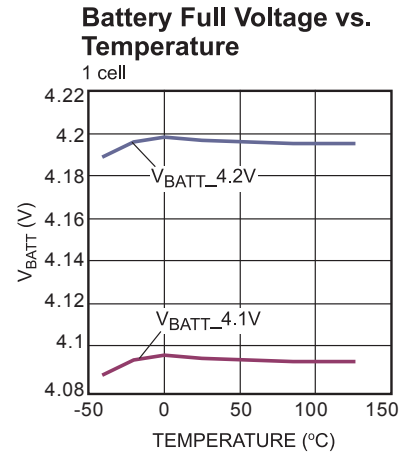
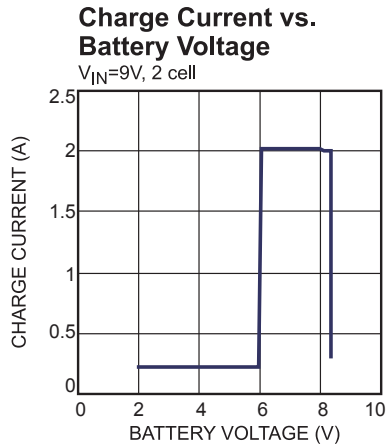
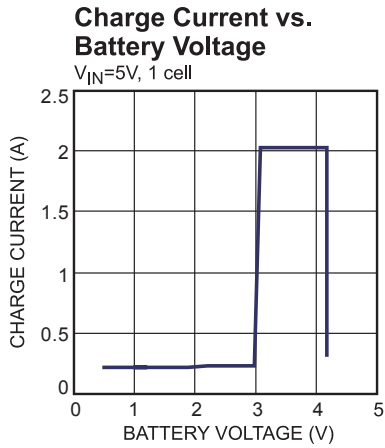

**TYPICAL PERFORMANCE CHARACTERISTICS (continued)**

$V_{IN} = 5V/9V$ ,  $C1=C2=22\mu F$ ,  $SEL=Float/High$ ,  $CELL=Float/High$ ,  $L=6.8\mu H$ ,  $RS1=50m\Omega$ , Battery Simulator,  $T_A = 25^\circ C$ , unless otherwise noted.

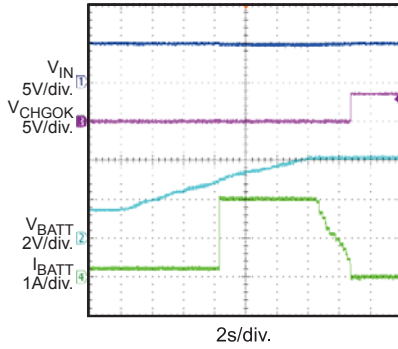
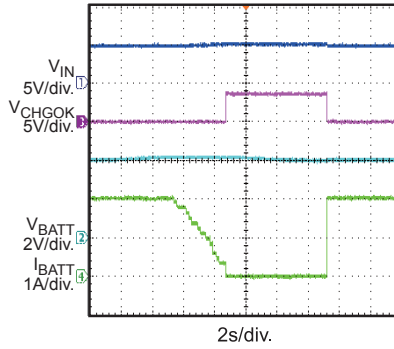
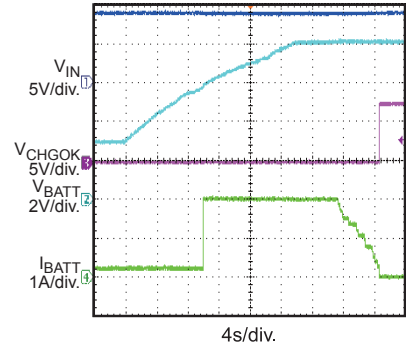
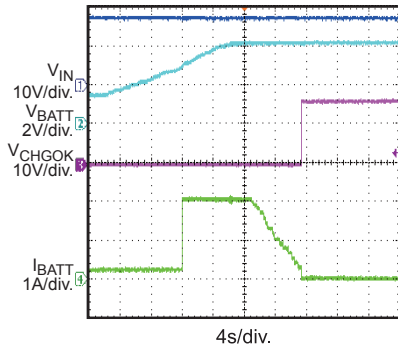
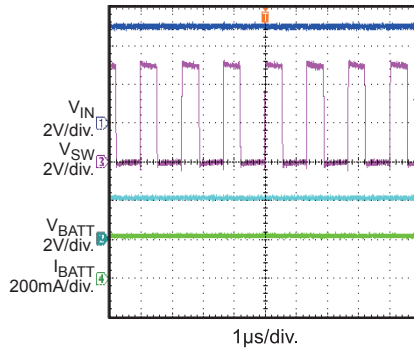
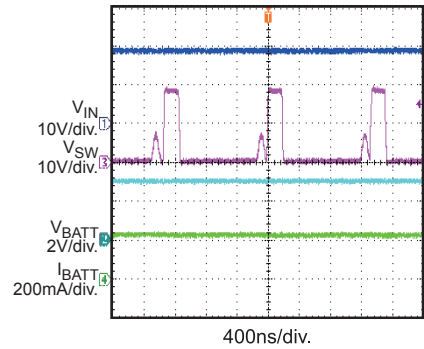
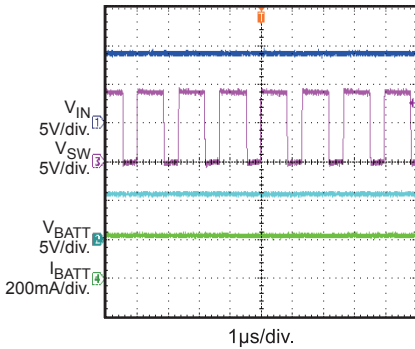
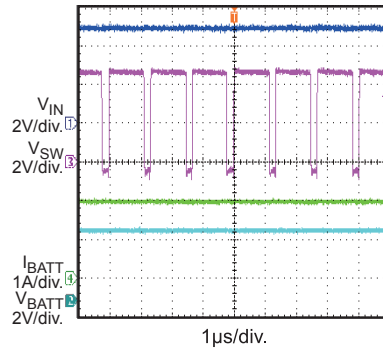
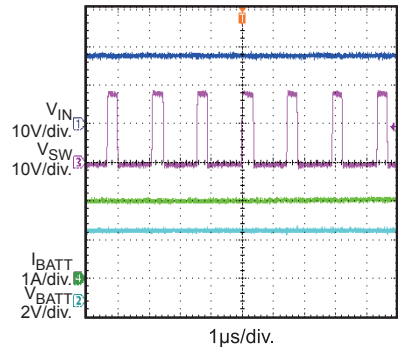
**Battery Charge Curve**
 $V_{IN} = 5V$ , 1 Cell

**Auto-Recharge**
 $V_{IN} = 5V$ , 1 Cell

**Battery Charge Curve**
 $V_{IN} = 9V$ , 2 Cell, 4.1V/cell

**Battery Charge Curve**
 $V_{IN} = 18V$ , 1 Cell

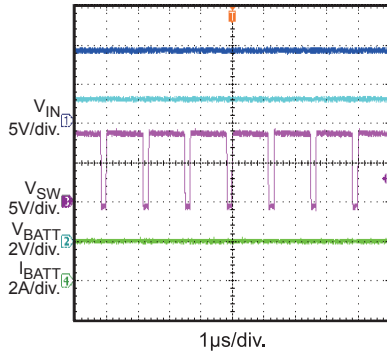
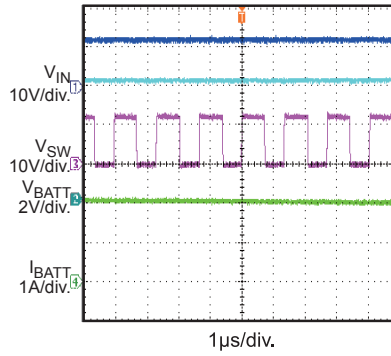
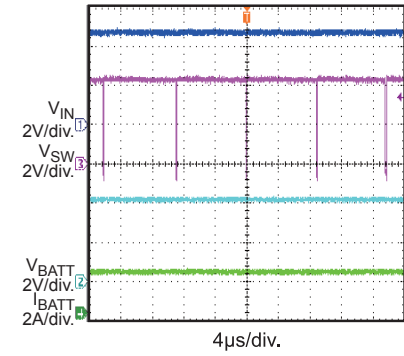
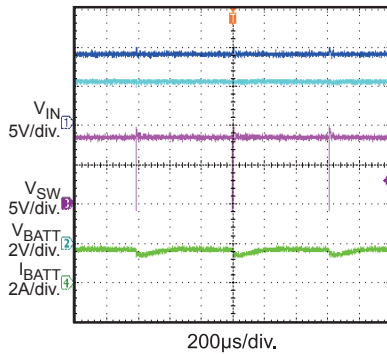
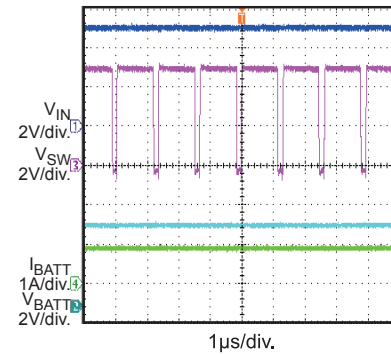
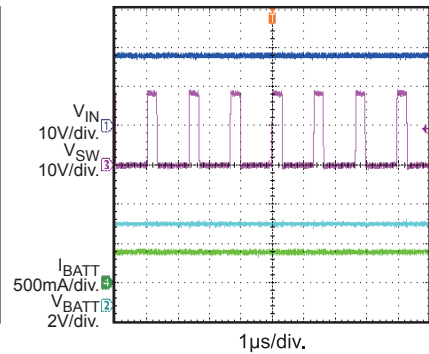
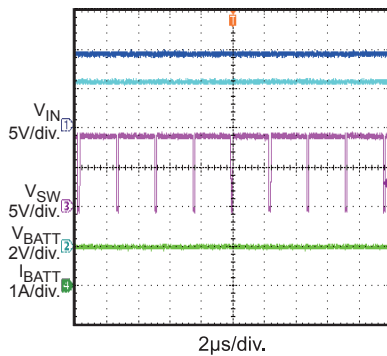
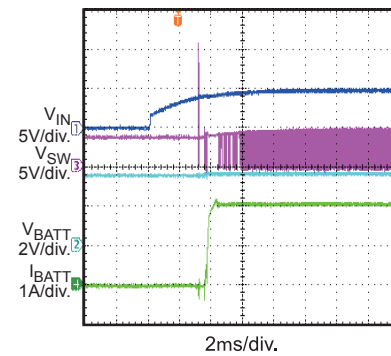
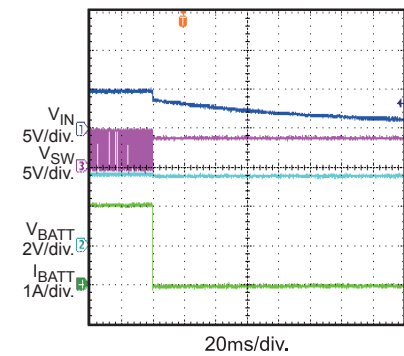
**TC Steady State**
 $V_{IN} = 5V$ , 1 Cell,  $V_{BATT} = 2V$ 

**TC Steady State**
 $V_{IN} = 18V$ , 1 Cell,  $V_{BATT} = 2.9V$ 

**TC Steady State**
 $V_{IN} = 9V$ , 2 Cell,  $V_{BATT} = 5.8V$ 

**CC Steady State**
 $V_{IN} = 5V$ , 1 Cell,  $V_{BATT} = 3.6V$ 

**CC Steady State**
 $V_{IN} = 18V$ , 1 Cell,  $V_{BATT} = 3.6V$ 



**TYPICAL PERFORMANCE CHARACTERISTICS (continued)**

$V_{IN} = 5V/9V$ ,  $C1=C2=22\mu F$ ,  $SEL=Float/High$ ,  $CELL=Float/High$ ,  $L=6.8\mu H$ ,  $RS1=50m\Omega$ , Battery Simulator,  $T_A = 25^\circ C$ , unless otherwise noted.

**CC Steady State**
 $V_{IN} = 9V$ , 2 Cell,  $V_{BATT} = 7.2V$ 

**CC Steady State**
 $V_{IN} = 12V$ , 2 Cell,  $V_{BATT} = 6V$ 

**CC Steady State (COT)**
 $V_{IN} = 4.75V$ , 1 Cell,  $V_{BATT} = 4.1V$ 

**CC Steady State (BST Refresh)**
 $V_{IN} = 8.75V$ , 2 Cell,  $V_{BATT} = 8.2V$ 

**CV Steady State**
 $V_{IN} = 5V$ , 1 Cell,  $V_{BATT} = 4.2V$ 

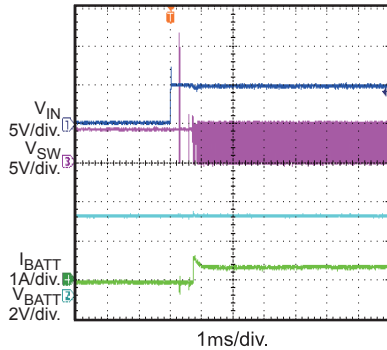
**CV Steady State**
 $V_{IN} = 18V$ , 1 Cell,  $V_{BATT} = 4.2V$ 

**CV Steady State (COT)**
 $V_{IN} = 9V$ , 2 Cell,  $V_{BATT} = 8.4V$ 

**Power On**
 $V_{IN} = 5V$ , 1 Cell,  $V_{BATT} = 3.6V$ 

**Power OFF**
 $V_{IN} = 5V$ , 1 Cell,  $V_{BATT} = 3.6V$ 

**TYPICAL PERFORMANCE CHARACTERISTICS (continued)**

$V_{IN} = 5V/9V$ ,  $C1=C2=22\mu F$ ,  $SEL=Float/High$ ,  $CELL=Float/High$ ,  $L=6.8\mu H$ ,  $RS1=50m\Omega$ , Battery Simulator,  $T_A = 25^\circ C$ , unless otherwise noted.

**Hot Insertion**

$V_{IN} = 5V$ , 1 Cell,  $V_{BATT} = 4.2V$

**Hot Insertion**

$V_{IN} = 12V$ , 1 Cell,  $V_{BATT} = 3.6V$

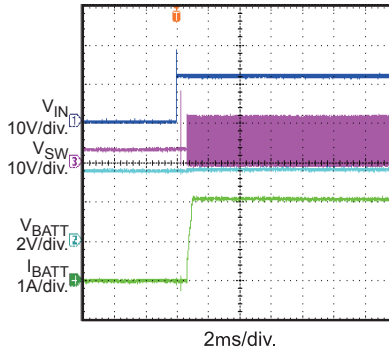
**Power On**

$V_{IN} = 12V$ , 1 Cell,  $V_{BATT} = 4.2V$

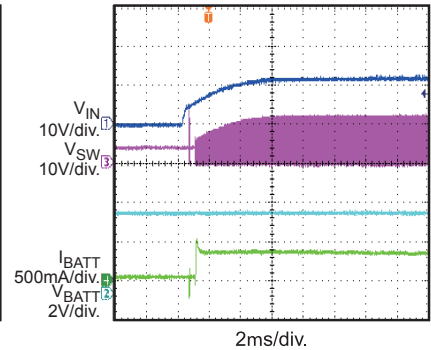
**Power On**

$V_{IN} = 9V$ , 2 Cell,  
 $V_{BATT} = 7.2V$ , 4.1V/cell

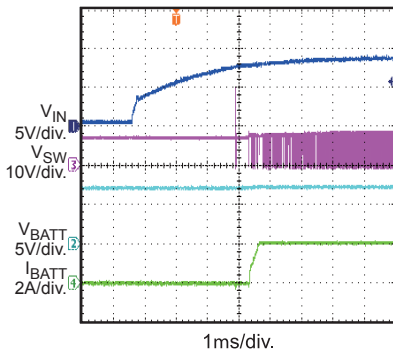
**Power Off**

$V_{IN} = 9V$ , 2 Cell,  
 $V_{BATT} = 7.2V$ , 4.1V/cell

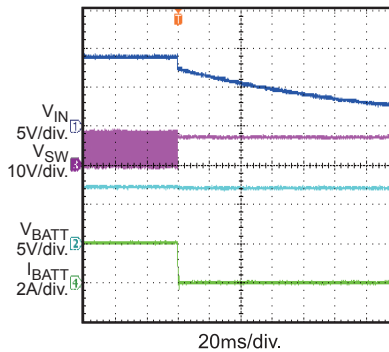
**Hot Insertion**

$V_{IN} = 9V$ , 2 Cell,  
 $V_{BATT} = 8.2V$ , 4.1V/cell

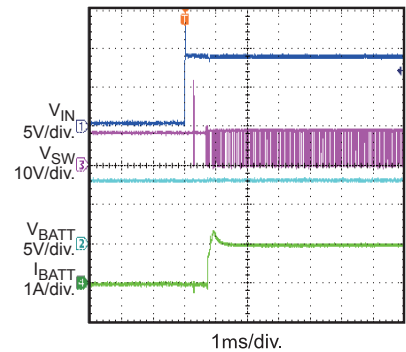
**Hot Insertion**

$V_{IN} = 9V$ , 2 Cell,  
 $V_{BATT} = 8.2V$ , 4.1V/cell

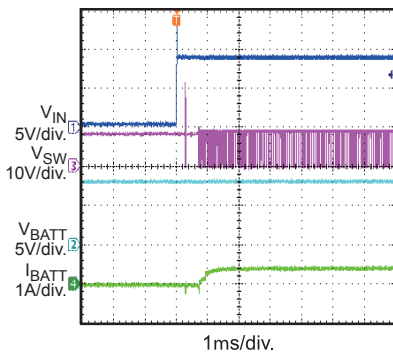
**Power On**

$V_{IN} = 18V$ , 2 Cell,  $V_{BATT} = 7.2V$

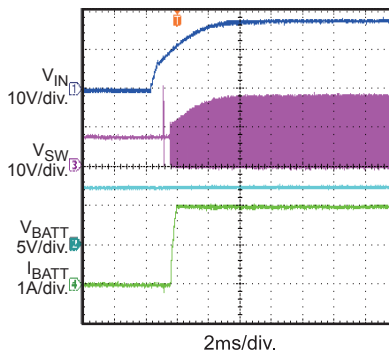
**Power On**

$V_{IN} = 18V$ , 2 Cell,  $V_{BATT} = 8.4V$

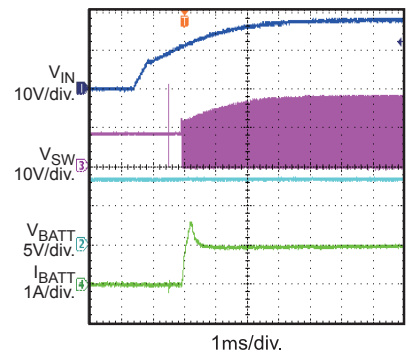

**TYPICAL PERFORMANCE CHARACTERISTICS (continued)**

$V_{IN} = 5V/9V$ ,  $C1=C2=22\mu F$ ,  $SEL=Float/High$ ,  $CELL=Float/High$ ,  $L=6.8\mu H$ ,  $RS1=50m\Omega$ , Battery Simulator,  $T_A = 25^\circ C$ , unless otherwise noted.

**Power Off**

$V_{IN} = 18V$ , 2 Cell,  $V_{BATT} = 8.4V$

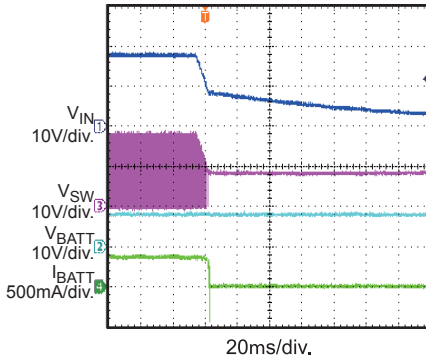
**En On**

$V_{IN} = 5V$ , 1 Cell,  $V_{BATT} = 3.6V$

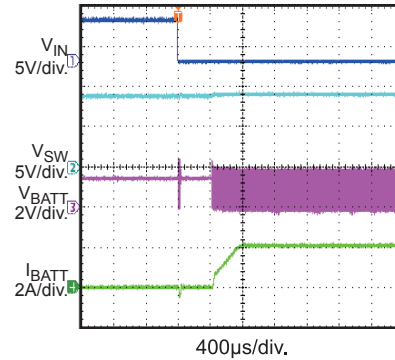
**En Off**

$V_{IN} = 5V$ , 1 Cell,  $V_{BATT} = 3.6V$

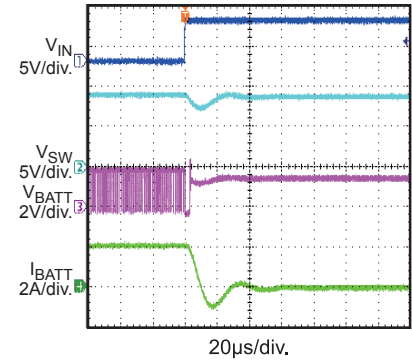
**En On**

$V_{IN} = 5V$ , 1 Cell,  $V_{BATT} = 4.2V$

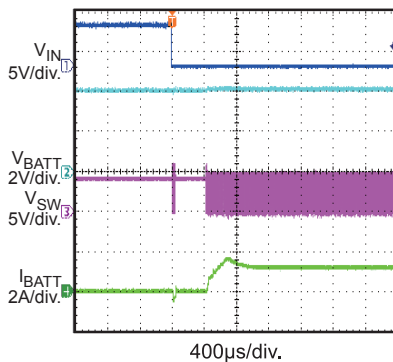
**En On**

$V_{IN} = 9V$ , 2 Cell,  $V_{BATT} = 7.2V$

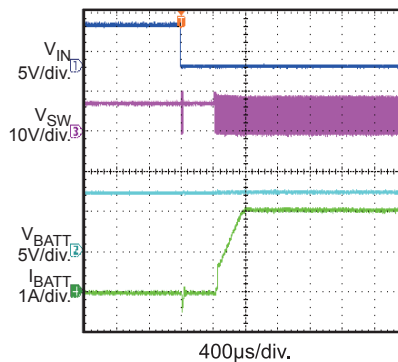
**En Off**

$V_{IN} = 9V$ , 2 Cell,  $V_{BATT} = 8.4V$

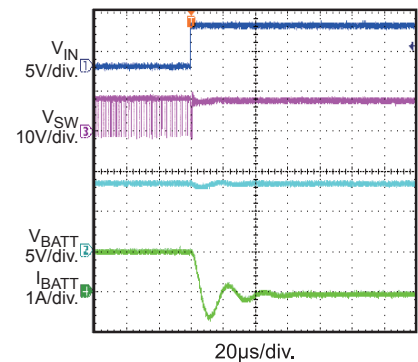
**NTC Fault Control**

$V_{IN} = 5V$ , 1 Cell,  $V_{BATT} = 3.6V$

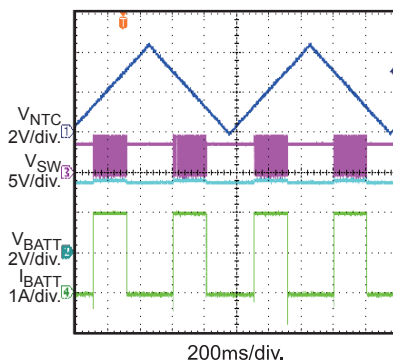

**Timer Out**

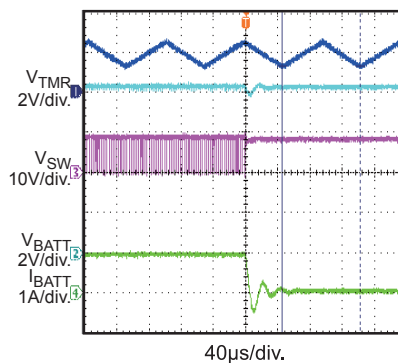
$V_{IN} = 9V$ , 2 Cell,  
 $V_{BATT} = 8.4V$ ,  $C_{TMR} = 220pF$

**Charge Full Indication**

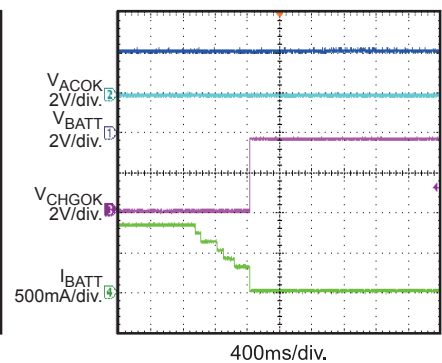
$V_{IN} = 5V$ , 1 Cell,  $V_{BATT} = 4.2V$

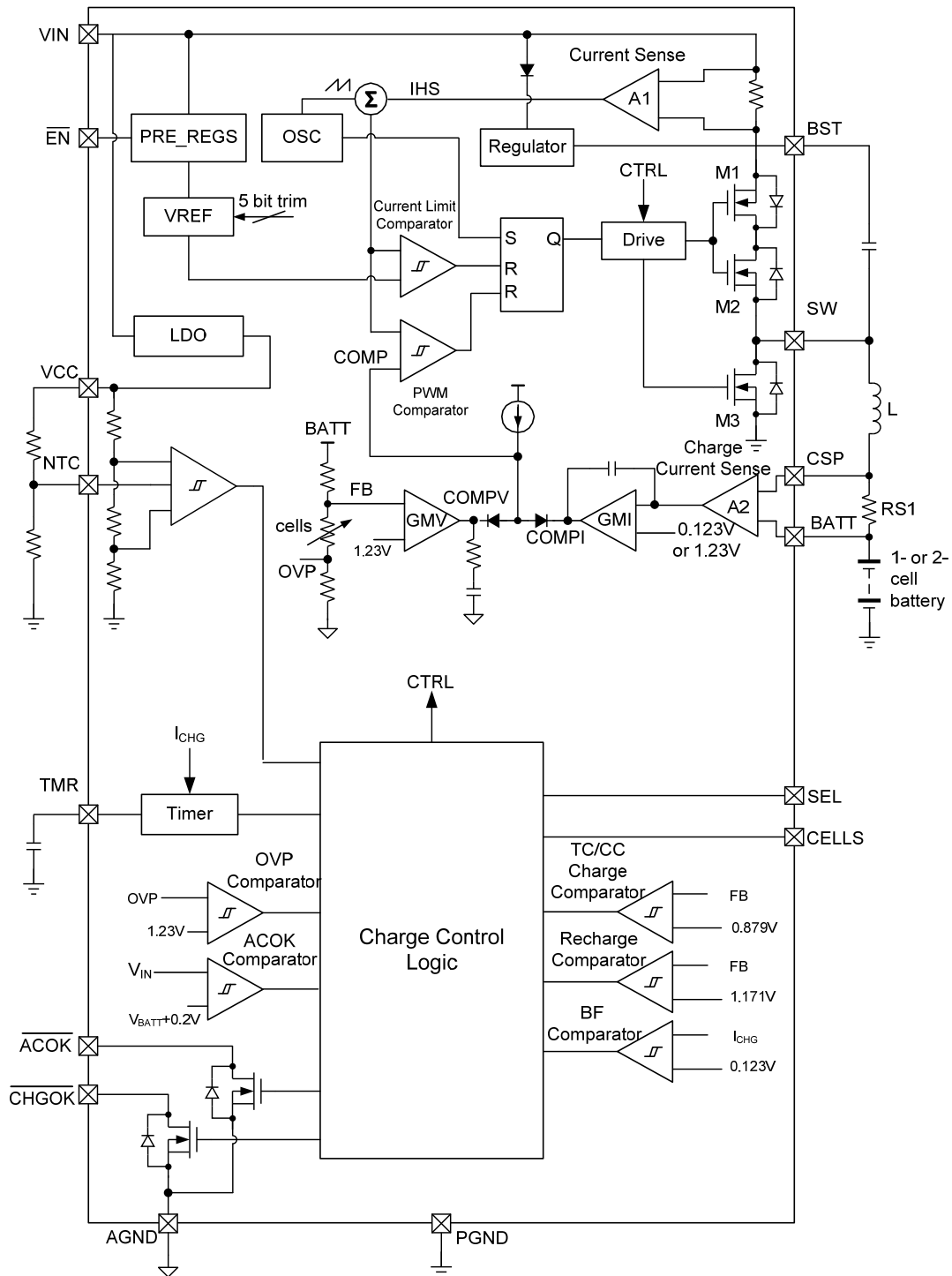

**FUNCTIONAL BLOCK DIAGRAM**

**Figure 1: Functional Block Diagram**

## OPERATION

The MP2615 is a peak current mode controlled switching charger for 1- or 2- cell lithium-ion and lithium-polymer battery. The MP2615 integrates both the high-side and low-side switches of the synchronous BUCK converter to provide high efficiency and save on PCB area.

### Charge Cycle (Mode change: TC → CC → CV)

The MP2615 regulates the charge current ( $I_{CHG}$ ) and battery voltage ( $V_{BATT}$ ) using two control loops to achieve highly-accurate constant current (CC) charge and constant voltage (CV) charge.

As shown in Figure 2, when the  $V_{BATT} < V_{TC}$ , the MP2615 stays in trickle-charge mode and the output of charge current loop COMPI dominates the control. The battery is charged by a trickle-charge current  $I_{TC}$  until the battery voltage

reaches  $V_{TC}$ . If the charger stays in the trickle-charge mode till the trickle-charge timer is triggered, charging will be terminated.

The MP2615 will enter constant-current charge mode once the battery voltage rises higher than  $V_{TC}$ . In this mode the charge current will increase from  $I_{TC}$  to  $I_{CC}$  to fast charge the battery.

When the battery voltage rises over full battery voltage  $V_{BATT\_FULL}$ , the charger enters into constant-voltage mode. In constant voltage mode, the battery voltage is regulated at  $V_{BATT\_FULL}$  precisely and the charge current will fall naturally due to the existing equivalent internal resistance of the battery. For the operation flow chart, please also refer to Figure 4.

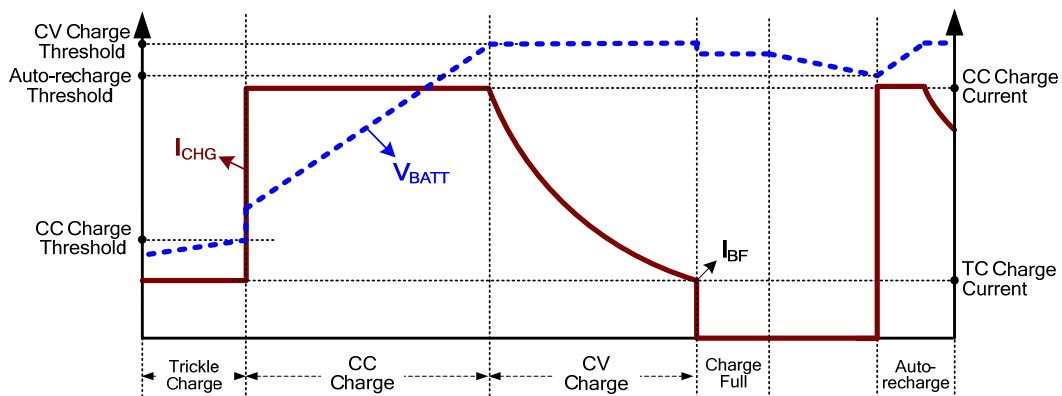

**Figure 2: Li-ion Battery Charge Profile**

### Charge Full Termination and Auto-Recharge

When the charge current drops below the termination threshold ( $I_{BF}$ ) during the CV charge phase, the charger will stop charging and the  $\overline{CHGOK}$  pin becomes open drain. The timer will also be reset and turned off. Once the battery voltage decreases below the recharge threshold  $V_{RECH}$  (4.0V/Cell while connect SEL-pin to AGND), recharging will automatically kick in and the timer restarts a new charge cycle.

### COT Charge Mode

The MP2615 uses the floating ground method to drive the high-side MOSFET of the buck converter. During the off-time of the high-side MOSFET, the BST capacitor is recharged and the voltage across it is used as the HS-MOS gate drive. Thus a minimum off-time 200ns is required to maintain sufficient voltage at BST capacitor.

When 200ns minimum off-time is achieved due to large duty cycle, the MP2615 will enter COT (constant off-time) charge mode. In this mode of operation, switching frequency is slightly decreased in order to achieve 99% duty cycle.

### Charge Status Indication

The MP2615 has two open-drain status outputs,  $\overline{CHGOK}$  pin and  $\overline{ACOK}$  pin. The  $\overline{ACOK}$  pin goes low when the input voltage is 300mV larger than battery voltage and over the under voltage lockout threshold. Pin  $\overline{CHGOK}$  is used to indicate the status of the charge cycle. Table 1 summarized the operation of both  $\overline{CHGOK}$  and  $\overline{ACOK}$  according to the status of charge.

**Table 1: Charging Status Indication**

$\overline{ACOK}$	$\overline{CHGOK}$	Charger Status
Low	Low	In charging
Low	High impedance	End of charge; NTC fault; Timer out; $\overline{EN}$ disable; Thermal shutdown;
High impedance	High impedance	$V_{IN}$ absent; $V_{IN} - V_{BATT} < 0.3V$

### Safety Timer Operation

The MP2615 has an internal safety timer to terminate charging during time out. The capacitor  $C_{TMR}$  connected between the TMR pin and GND is used to set the internal oscillator period,

$$T_p(\text{seconds}) = 0.46 \times C_{TMR}(\text{uF}) \quad (1)$$

This timer limits the max trickle charge time to 8192 internal oscillating periods. If the charger stays in trickle charge mode for longer than the max oscillating periods, it will be terminated and the  $\overline{CHGOK}$  becomes open drain to indicate the timer-out fault. If charge cycle successfully goes through trickle charge within the allowed time limit, it enters into the CC charge mode and the timer continues to count the oscillating periods. When the battery is charged full, the timer turns off and clears the counter, waiting for the auto-recharge to restart.

If the charge time during CC/CV mode exceeds 49152 oscillating periods and the battery full has not been qualified, the charger will be terminated and a timer-out fault is also indicated by floating the  $\overline{CHGOK}$ . The charger can exit the timer-out fault state and the on-chip safety timer restarts counting when one of the following conditions occurs:

- The battery voltage falls below the auto-recharge threshold  $V_{RECH}$ .
- A power-on-reset (POR) event occurs;
- $\overline{EN}$  pin is toggled.

The timer can be disabled by pulling TMR-pin to AGND.

Thus, the trickle mode charge time is:

$$t_{\text{Trickle\_tmr}}(\text{minutes}) = 62.8 \times C_{TMR}(\text{uF}) \quad (2)$$

If connect a  $C_{TMR}$  of 0.47uF, the trickle charge time is about 30 minutes.

The CC/CV mode charge time is:

$$t_{\text{Total\_tmr}}(\text{hours}) = 6.28 \times C_{TMR}(\text{uF}) \quad (3)$$

If connect a  $C_{TMR}$  of 0.47uF, the CC/CV charge time is 2.95 hours.

### **Negative Thermal Coefficient (NTC) Thermistor**

The NTC pin allows the MP2615 to sense the battery temperature using the Negative Thermal Coefficient (NTC) resistor available in the battery pack to ensure safe operating environment of the battery. . A resistor with appropriate value should be connected from VCC to NTC pin and the thermistor is connected from NTC pin to AGND. The voltage on the NTC-pin is determined by the resistor divider whose divide-ratio depends on the battery temperature. When the voltage at the NTC pin falls out of the NTC window range, the charging will pause until the battery temperature goes back to normal operating conditions.

As a result the MP2615 will stop charging and report this condition to the status pins. Charging will automatically resume after the temperature falls back within safe range.

### **Short Circuit Protection**

The MP2615 has an internal comparator to check for battery short circuit. Once  $V_{BATT}$  falls below 2V, the device detects a battery-short status and the cycle-by-cycle peak current limit falls to about 2.2A to limit the current spike during the battery-short transition. Furthermore, the switching frequency also folds back to minimize the power loss.

### **Thermal Shutdown Protection**

To prevent the chip from overheating during charging, the MP2615 monitors the junction temperature,  $T_J$ , of the die. Once  $T_J$  reaches the thermal shutdown threshold ( $T_{SHTDWN}$ ) of 150°C, the charger converter turns off. Once the  $T_J$  falls below 130°C the charging will restart.

### INPUT POWER UP START UP TIMING FLOW

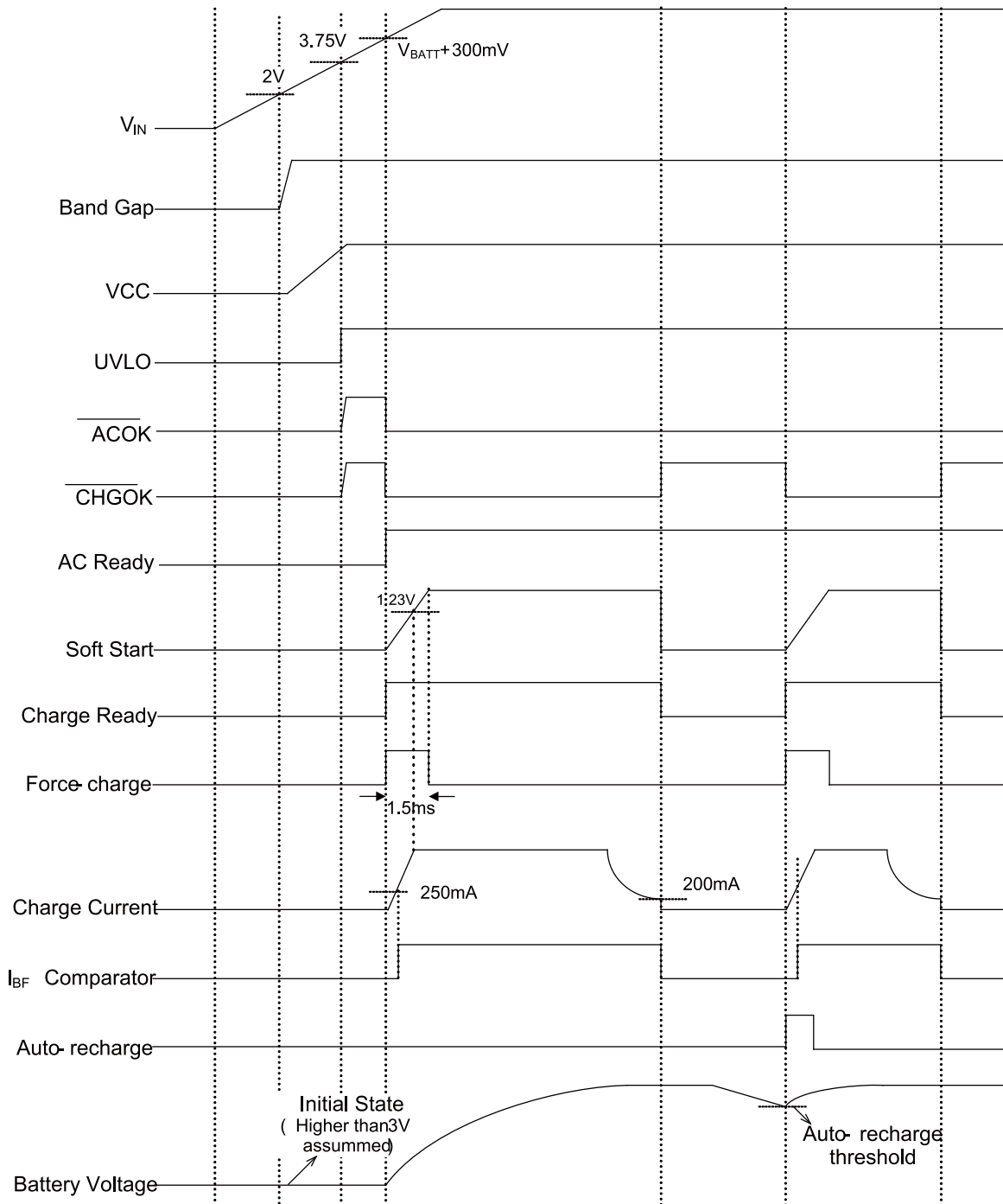

Figure 3: Input Power Start-up Timing Diagram



**OPERATION FLOW CHART**

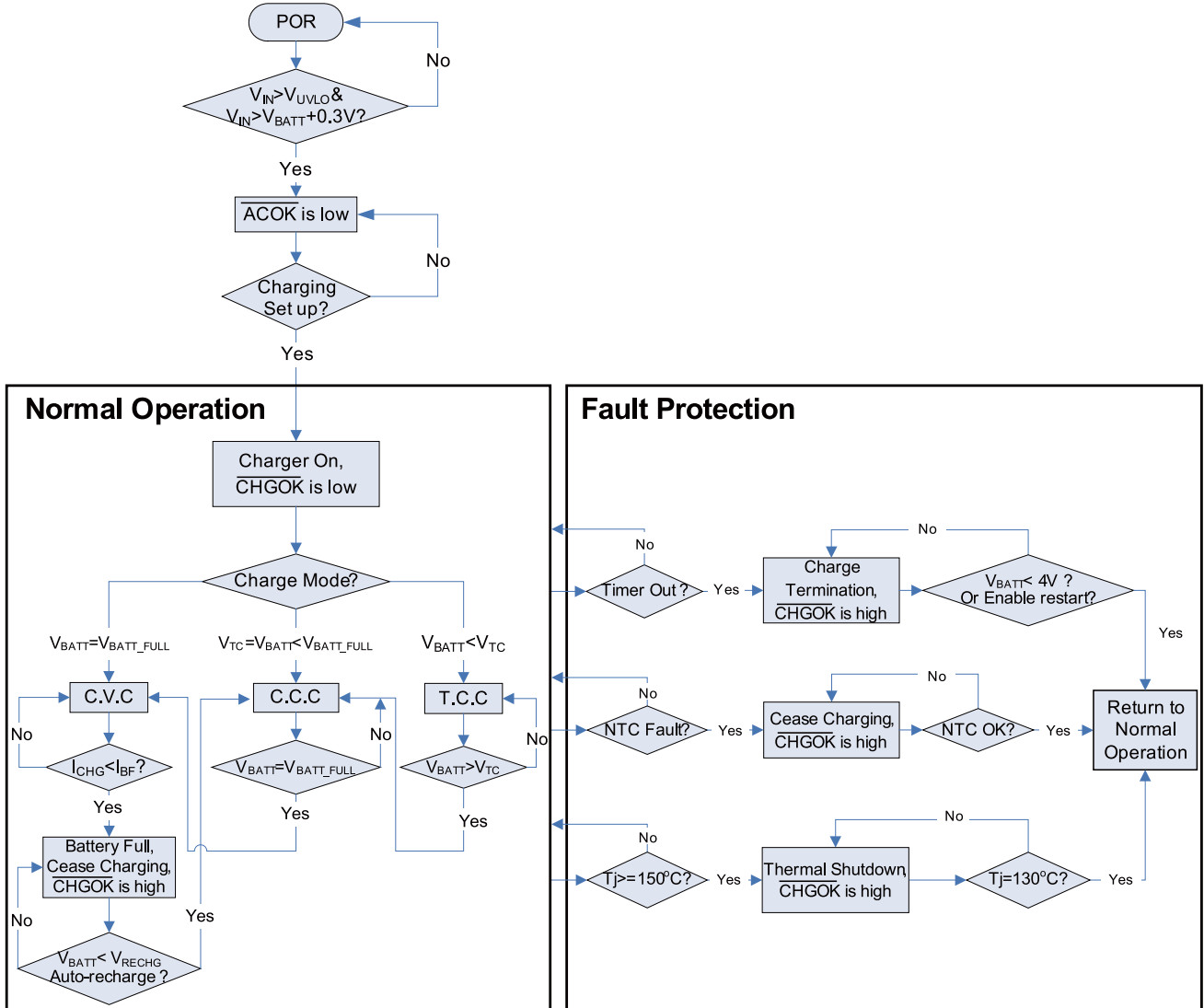

Figure 4: Operation Flow Chart

## APPLICATION INFORMATION

### COMPONENT SELECTION

#### Charge Current Setting

The constant charge current ( $I_{CC}$ ) of the MP2615 can be set by the sense resistor RS1 (see Typical Application). The equation to determine the programmable CC-charge current is expressed as following,

$$I_{CC} = \frac{100\text{mV}}{RS1(\text{m}\Omega)} (\text{A}) \quad (4)$$

To get 2A  $I_{CC}$ , a RS1 of 50m $\Omega$  should be selected.

Accordingly, the trickle charge current ( $I_{TC}$ ) can be obtained by the following equation,

$$I_{TC} = 10\%I_{CC} = \frac{10\text{mV}}{RS1(\text{m}\Omega)} (\text{A}) \quad (5)$$

#### Inductor Selection

To select the right inductor, a trade off should be made between cost, size, and efficiency. An inductor of lower inductance value corresponds with smaller size, but it results in higher ripple currents, higher magnetic hysteretic losses, and higher output capacitances. Conversely, higher inductance value is beneficial to getting a lower ripple current and smaller output filter capacitors, but resulting in higher inductor DC resistance (DCR) loss. Based on practical experience, the inductor ripple current should not exceed 30% of the maximum charge current under worst cases. For the MP2615 with a typical 12V input voltage to charge a 2-cell battery, the maximum inductor current ripple occurs at the corner point between trickle charge and CC charge ( $V_{BATT} = 6\text{V}$ ). Inductance estimations are as follow:

$$L = \frac{V_{IN} - V_{BATT}}{\Delta I_{L\_MAX}} \cdot \frac{V_{BATT}}{V_{IN} \cdot f_s} \quad (6)$$

Where  $V_{IN}$ ,  $V_{BATT}$ , and  $f_s$  are the typical input voltage, the CC charge threshold, and the switching frequency, respectively. And  $\Delta I_{L\_MAX}$  is the maximum inductor ripple current, which is usually 30% of the CC charge current.

$$\Delta I_{L\_MAX} = 30\%I_{CC} \quad (7)$$

Based on the condition where  $I_{CC} = 2\text{A}$ ,  $V_{IN} = 12\text{V}$ ,  $V_{BATT} = 6\text{V}$  and  $f_s = 760\text{kHz}$  the calculated inductance is 6.6 $\mu\text{H}$ . The inductor saturation current must exceed 2.6A at least and have

some tolerance. To optimize efficiency, chose an inductor with a DC resistance less than 50m $\Omega$ .

#### NTC Resistor Divider Selection

Figure shows that an internal resistor divider is used to set the low temperature threshold and high temperature threshold at 73.3%·VCC and 29.3%·VCC, respectively. For a given NTC, thermistor, select appropriate  $R_{T1}$  and  $R_{T2}$  to set the NTC window.

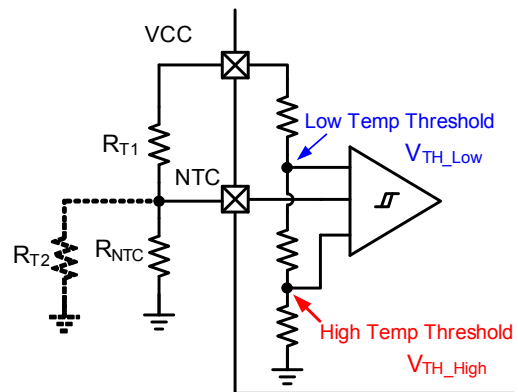

**Figure 5: NTC Function Block**

The thermistor (NCP18XH103) noted above has the following electrical characteristic:

- At 0°C,  $R_{NTC\_Cold} = 27.445\text{k}\Omega$ ;
- At 50°C,  $R_{NTC\_Hot} = 4.1601\text{k}\Omega$ .

The following equations are derived assuming that the NTC window is between 0°C and 50°C:

$$\frac{R_{T2} // R_{NTC\_Cold}}{R_{T1} + R_{T2} // R_{NTC\_Cold}} = \frac{V_{TH\_Low}}{V_{REF33}} = 73.3\% \quad (8)$$

$$\frac{R_{T2} // R_{NTC\_Hot}}{R_{T1} + R_{T2} // R_{NTC\_Hot}} = \frac{V_{TH\_High}}{V_{REF33}} = 29.3\% \quad (9)$$

According to Equation (8) (9), and the required battery temperature range to calculate  $R_{T1}$  and  $R_{T2}$ .

#### Input Capacitor Selection

The input capacitors C1 from the typical application circuit absorbs the maximum ripple current from the buck converter, which is given by:

$$I_{RMS\_MAX} = I_{CC} \frac{\sqrt{V_{TC}(V_{IN\_MAX} - V_{TC})}}{V_{IN\_MAX}} \quad (10)$$

For a given  $I_{CC} = 2A$ ,  $V_{TC} = 6V$ ,  $V_{IN\_MAX} = 18V$ , the maximum ripple current is 1A. Select the input capacitors so that the temperature rise due to the ripple current does not exceed  $10^{\circ}C$ . Use ceramic capacitors with X5R or X7R dielectrics because of their low ESR and small temperature coefficients. For most applications, use a  $22\mu F$  capacitor.

### Output Capacitor Selection

The output capacitor C2 (see the typical application circuit) is in parallel with the battery. C2 absorbs the high-frequency switching ripple current and smoothes the output voltage. Its impedance must be much less than that of the battery to ensure it absorbs the ripple current. Use a ceramic capacitor because it has lower ESR and smaller size.. The output voltage ripple is given by,

$$\Delta r_o = \frac{\Delta V_o}{V_o} = \frac{1 - \frac{V_o}{V_{IN}}}{8C_o f_s^2 L} \quad (11)$$

In order to guarantee  $\pm 0.5\%$  full battery voltage accuracy, the maximum output voltage ripple must not exceed 0.5% (e.g., 0.1%). The maximum output voltage ripple occurs at the minimum battery voltage of the CC charge and the maximum input voltage.

For  $V_{IN\_MAX} = 18V$ ,  $V_{CC\_MIN} = V_{TC} = 6V$ ,  $L = 6.8\mu H$ ,  $f_s = 760kHz$ ,  $\Delta r_o\_MAX = 0.1\%$ , the output capacitor can be calculated as,

$$C_o = \frac{1 - \frac{V_{TC}}{V_{IN\_MAX}}}{8f_s^2 L \Delta r_o\_MAX} = 21.3\mu F \quad (12)$$

We can then approximate this value and choose a  $22\mu F$  ceramic capacitor.

### PCB Layout Guide

PCB layout is important to meet specified noise, efficiency and stability requirements. The following design considerations can improve circuit performance,

- 1) Route the power stage adjacent to the grounds. Aim to minimize the high-side switching node (SW, inductor), trace lengths in the high-current paths and the current-sense resistor trace. Keep the switching node short and away from the feedback network.
- 2) Connect the charge current sense resistor to CSP (pin 10), BATT (pin 9). Minimize the length and area of this circuit loop.
- 3) Place the input capacitor as close as possible to the VIN and PGND pins. Place the output inductor close to the IC as and connect the output capacitor between the inductor and PGND of the IC. This minimizes the current path loop area from the SW pin through the LC filter and back to the PGND pin.
- 4) Connect AGND and PGND at a single point.
- 5) Figure 6 is a PCB layout reference design.

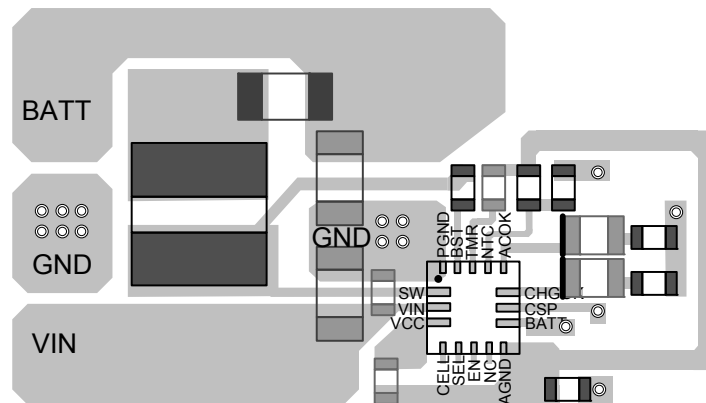

**Figure 6: MP2615 PCB Guild Design**

TYPICAL APPLICATION CIRCUITS

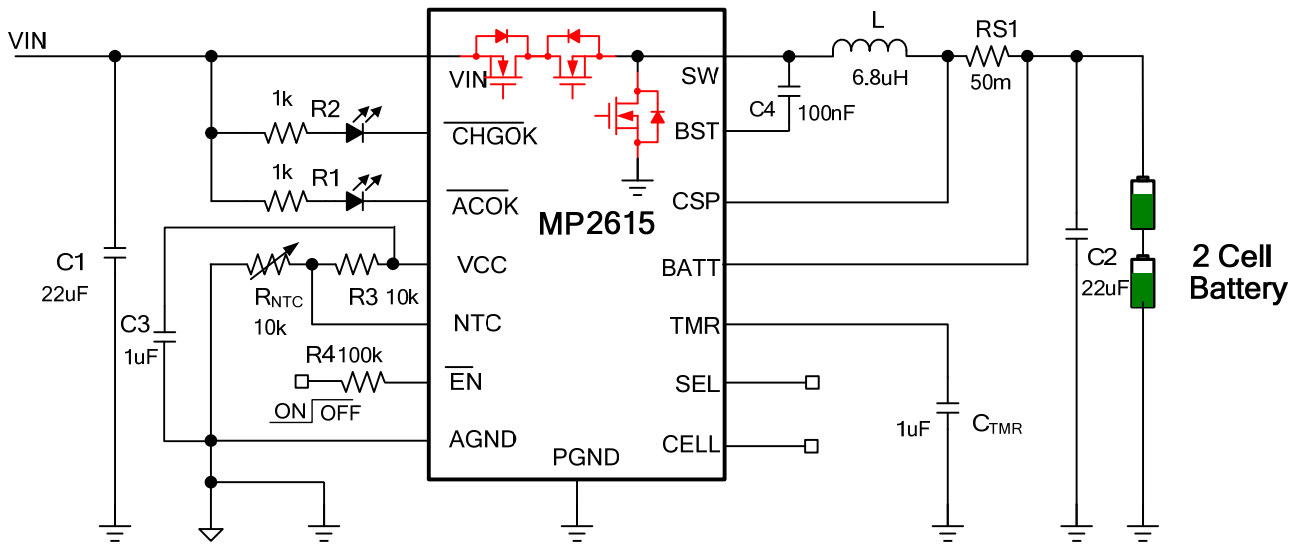
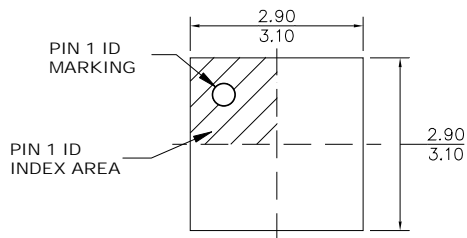
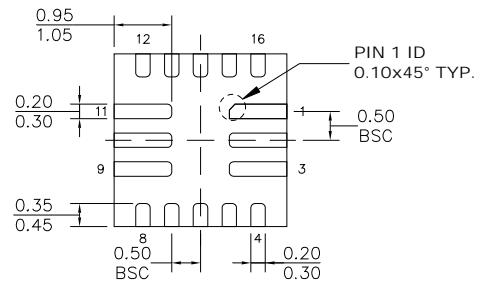
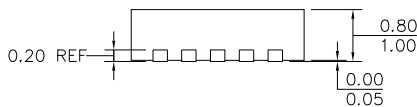
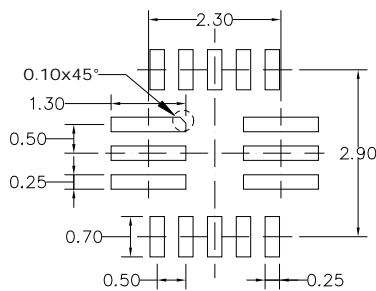

Figure 7: Typical Application Circuit to Charge a 2 Cell Battery with 12VIN.

**PACKAGE INFORMATION**
**QFN-16 (3mmX3mm)**

TOP VIEW

BOTTOM VIEW

SIDE VIEW

RECOMMENDED LAND PATTERN
**NOTE:**

- 1) ALL DIMENSIONS ARE IN MILLIMETERS.
- 2) EXPOSED PADDLE SIZE DOES NOT INCLUDE MOLD FLASH.
- 3) LEAD COPLANARITY SHALL BE 0.10 MILLIMETERS MAX.
- 4) JEDEC REFERENCE IS MO-220.
- 5) DRAWING IS NOT TO SCALE.

**NOTICE:** The information in this document is subject to change without notice. Please contact MPS for current specifications. Users should warrant and guarantee that third party Intellectual Property rights are not infringed upon when integrating MPS products into any application. MPS will not assume any legal responsibility for any said applications.